

## » The Profile System

English  
1/2018

 MayTec®

# The key to success!



## Solutions with Innovative Profile

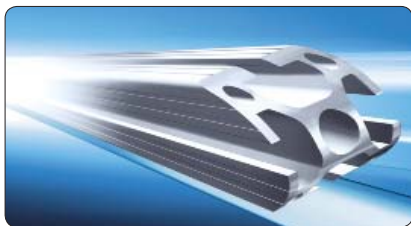

The Profile System



The Clean-Room System

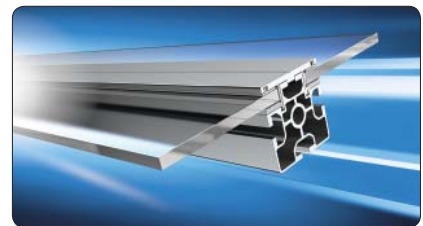

The Modular Wall System



The Tube Clamping System



The Telescopic System



The Linear System

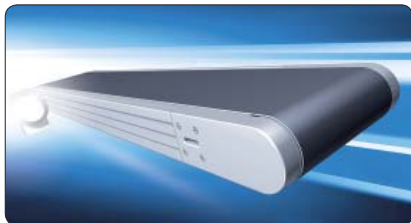

The Conveyor System



The People Mover System



The Skid Transfer System



Safety Barriers



The Dust Protection System



The Pipe & Joint System

### The ideal profile system

MayTec offers a comprehensive, harmonised profile system. All profiles can be combined in any way conceivable.

The accessories provide functional and aesthetic solutions for a wide range of applications.

### Service

The MayTec service is as versatile as the MayTec profile system.

You may choose:

- delivery of standard elements ex-factory
- delivery of profiles and accessories cut to size according to parts list for customer's assembly
- delivery of pre-fitted modular components
- delivery of completely assembled units
- assembly at your premises

### Implementation

The MayTec profile system is easy to process and quick to assemble. Its flexible and modular construction means it can be easily modified and is reusable at any time.

An experienced team will support you in implementing the MayTec system, tailored to your individual applications, taking into consideration your dimensions, loading capacity and stability.

**Table of contents**

Introduction	1.0
--------------	-----

**Profiles**
**Summary**

Profiles	1.1
Profile machining	1.1A
- Coding examples	1.1B
Technical data	1.1C
Profile selection range	1.1D
Profile applications	1.1E
- Curved profiles	1.1E

**Connection system**
**Summary**

Connector selection	1.2
Connectors	1.2A
- Cross bushings	1.2B
- Components	1.2C
- Special cases	1.2D
Connection possibilities	1.2E
Connector-Strength values	1.2F
Connection elements	1.29

**Accessories**
**Summary**

Fastening elements	1.3
Installation accessories	1.4
Pneumatic accessories	1.5
Additional accessories	1.6
Electrical accessories	1.7
Panel elements	1.8
Washers, screws and tools	1.9

**Subject index**





Article number group	Page	Article number group	Page
<b>Introduction.....</b>	<b>5</b>	1.1E.04	U-Profile 40 ..... 78
1.01 Symbols, Abbreviations, Special characters .....	5	1.1E.05	Profiles for cable guide ..... 79
1.02 Slot system .....	6	1.1E.06	Profiles for cable guide, Profile pre-cut lid..... 80
1.03 Numerical key for articles.....	7	1.1E.07	Curved profiles..... 83
<b>1.1 Profiles.....</b>	<b>8</b>	<b>1.2 Connection System.....</b>	<b>85</b>
1.04 Summary: Profiles .....	8	1.2 Connectors - Examples .....	87
1.04 Profiles (plain) .....	8, 9	1.2 Summary: Connectors.....	88
1.04 Profiles (with grooves).....	9	1.2 Connectors (with machining).....	88
1.04 Profiles .....	10	1.2 Connectors (without machining) .....	90
1.09 Profile group 16 mm, E3-slot, P .....	13	1.2 Manufacture a connection.....	92
1.10 Profile group 16 mm, F-slot, P .....	14	1.2 Connector selection .....	93
1.10 Profile group 20 mm, H-slot, P .....	15	1.2A Connectors.....	94
1.11 Profile group 20 mm, F-slot, P.....	17	1.2A for profiles with core hole-Ø 6 mm .....	94
1.11 Profile group 30 mm, F / E4-slot, P .....	18	1.2A für profiles with core hole-Ø 12 mm .....	96
1.11 Profile group 40 mm, E3-slot, P.....	22	1.2B Connector - Cross bushings .....	102
1.11 Profile group 45 mm, E4-slot, P.....	30	1.2B Drill dimensions for cross bushings .....	102
1.11 Profile group 50 mm, E4-slot, P.....	33	1.2B Special cases.....	103
1.11 Profile group 60 mm, E4-slot, P.....	34	1.2B Mounting variants.....	103
1.11 Profile group 30 mm, F-slot.....	36	1.2C Connector - Components .....	105
1.11 Profile group 40 mm, E3-slot.....	38	1.2C Connectors for core hole-Ø 6 mm .....	105
1.11 Profile group 45 mm, E4-slot.....	41	1.2C Connectors for core hole-Ø 12 mm .....	106
1.11 Profile group 50 mm, E4-slot.....	42	1.2D Connector - Special cases.....	110
1.11 Profile group 60 mm, E4-slot .....	44	1.2D Parallel connector for profile 30×30, soft.....	110
1.11 Profiles 48, round, P .....	45	1.2D Universal connector for profile 30×150 .....	110
1.11 Profiles octagonal, P .....	45	1.2D Extension / parallel connector .....	111
1.13 Panel bazel profiles 30, F-slot / 40, E3-slot, P .....	46	1.2D Universal connector with knurled cross b. ....	112
1.14 Panel profiles 30, F-slot, P .....	47	1.2D SE-Connector.....	113
1.14 Panel profiles 40, E3-slot, P .....	48	1.2D ST-Connector.....	114
1.14 Panel profiles 50, E4-slot, P .....	49	1.2D ST-Connector with anchor, screw type .....	115
1.15 Wire net profiles 30, F-slot, P .....	50	1.2D Connector screw, self-cutting.....	116
1.15 Wire net profiles 40, F / E3-slot, P .....	50	1.2D Cross connector.....	117
1.17 Tube profiles 30, P.....	51	1.2D Parallel connector for subsequent insertion.....	118
1.19 E-trunking profiles .....	52	1.2D Insertion connector.....	119
1.19 19" profiles .....	55	1.2E Connection possibilities.....	122
1.19 Tubes.....	55	1.2E for 0-slot profiles.....	122
1.19 Profile pre-cut lids .....	56	1.2E Specification of milling patterns for closed profiles .....	123
1.19 Wire net mounting profiles .....	56	1.2E for profiles 40, round.....	129
1.19 Grab handle profiles.....	56	1.2E Special cases.....	130
1.19 Sliding profiles.....	57	1.2E Other profile systems.....	131
1.19 U-profile.....	57	1.2F Connector-strength values.....	132
1.19 C-track .....	57	1.29 Connection elements.....	133
1.1A Profile machining.....	58	1.29 Anti-twist devices.....	133
1.1A Summary.....	58	1.29 Clamping levers .....	136
1.1A Order description.....	58	 	
1.1A Order example .....	58	<b>Accessories.....</b>	<b>137</b>
1.1A Saw cut .....	59	Summary: Accessories.....	137
1.1A Cross bushing bore .....	60	 	
1.1A Bores .....	60	<b>1.3 Fastening elements .....</b>	<b>141</b>
1.1A Cross bore.....	60	1.3 Summary: Fastening elements.....	141
1.1A Thread.....	60	1.31 Threaded plates.....	142
1.1A Direction and Position.....	61	1.32 T-Nuts.....	145
1.1B Profile machining: Coding examples.....	62	1.33 Spring-nuts.....	149
1.1B for price group 1 .....	62	1.34 T-Slot nuts .....	150
1.1B for price group 2 .....	63	1.34 Rhomboid T-Slot nuts.....	151
1.1B for price group 3 .....	66	1.34 T-Bolts.....	152
1.1B Order example for special design .....	64	1.35 Threaded inserts.....	153
1.1C Technical data .....	65	1.35 Press-fit threaded inserts .....	155
1.1D Profile selection range.....	68	 	
1.1E Profile applications .....	72	<b>1.4 Installation accessories .....</b>	<b>157</b>
1.1E.01 Profile combinations.....	72	1.41 Cover profiles .....	157
1.1E.01 Special slits .....	72	1.41 Sliding and cover profiles .....	158
1.1E.02 Slot plates.....	73	1.41 Reducing profiles.....	159
1.1E.03 Hand rail.....	76	1.41 Combination profiles .....	160

Article number group	Page	Article number group	Page
1.41	Guide profile.....	1.65	Bullet catches.....
1.41	Framing profiles.....	1.65	Magnetic lock.....
1.41	Wedge profiles.....	1.65	Lock.....
1.41	Sponge rubber round cords.....	1.65	Cylinder locks.....
1.41	Sealing profile.....	1.65	Flap-lock countersunk.....
1.41	Rubber cover-profiles.....	1.65	Cylinder locks flush.....
1.42	Cover caps for profiles.....	1.65	Mortise deadlocks.....
1.42	Cover plugs for cross bushings.....	1.65	Bar locks.....
1.42	Cover caps for tubes.....	1.65	Latch locks.....
1.42	Cover caps for screw bores.....	1.66	Rollers.....
1.43	Radius covers.....	1.66	Roller fastening sets.....
1.43	Radius compensations.....	1.66	Mounting adaptor for roller.....
1.44	Floor levelling screws.....	1.66	Edge roller.....
1.44	Levelling feet.....	1.66	Runner for sliding suspended doors.....
1.44	Hand adjustable feet.....	1.66	Stopper for sliding suspended doors.....
1.44	Levelling furniture foot.....	1.67	Slot rollers.....
1.44	Adjustable tilt-feet.....	1.67	Guidance system.....
1.44	plates.....	1.67	Sliding blocks.....
1.44	spindles.....	1.67	T-Nut sliding blocks.....
1.44	nuts.....	1.67	Eco-Slides.....
1.44	anti-slip discs.....	1.68	Hanging bracket.....
1.44	cushion elements.....	1.69	Suspended glider.....
1.44	Angular adjusting feet.....	1.69	Carabine swivel.....
1.44	Base feet.....		
1.44	Base angle.....	<b>1.7</b>	<b>Electrical accessories..... 304</b>
1.44	Stacking foot.....	1.70	Potential equalisation, grounding connectors.....
1.45	Castors.....	1.70	Ground connections.....
1.45	Locking castors.....	1.71	Cable and hose clamp.....
1.46	Angles.....	1.71	(Cross-) blocks for cable binder, cable binder.....
1.46	Aluminium.....	1.71	Installation rings.....
1.46	PA.....	1.72	Mounting set for 19" profile.....
1.46	GD-Zn.....	1.73	Safety interlocking-mountings.....
1.46	GD-Al.....	1.73	Contact bracket-mounting.....
1.46	Swivel angles.....	1.73	Sensor brackets.....
1.47	Cross connection plates.....	1.75	Electrical installation trunking.....
1.47	Base plates.....		
1.47	Floor mounting plate.....	<b>1.8</b>	<b>Panel elements..... 320</b>
1.47	Mounting plates.....	1.81	Corner elements.....
1.47	Floor plate.....	1.81	Corner element 33.....
1.47	Connection plates.....	1.81	Mounting sockets.....
1.47	Fastening plate.....	1.82	Panel elements.....
1.47	Eye bolt.....	1.82	Chipboards, coated.....
1.48	Corner pieces.....	1.83	Solid plastic panels.....
1.48	GD-Zn.....	1.85	Alu-plastic composite panels.....
1.48	Aluminium.....	1.87	Polycarbonate (Makrolon).....
		1.88	Wire net, Alu.....
<b>1.5</b>	<b>Pneumatic accessories..... 223</b>	1.88	Wire net, steel.....
1.51	Profiles for pneumatic applications.....	1.88	Grid, steel.....
1.51	Pneumatic end plates.....		
1.52	Pneumatic connection plates.....	<b>1.9</b>	<b>Washers, screws and tools..... 328</b>
1.54	Pneumatic extension sets.....	1.90	Self locking washers.....
1.55	Pneumatic 90° - connection sets.....	1.90	Button head screws.....
1.59	Pneumatic accessories.....	1.90	Lens head screws.....
		1.98	Press in device.....
<b>1.6</b>	<b>Additional accessories..... 233</b>	1.98	Hexagonal tools.....
1.61	Handles.....	1.98	Torx® Tools.....
1.61	Handle systems.....	1.99	Summary: Tools for cross bushings and anchors.....
1.61	Grab handles.....	1.99	Drill Jigs.....
1.62	Hinges.....	1.99	Milling cutters.....
1.62	Double hinge.....	1.99	Drills.....
1.63	Joints.....	1.99	Tools: Special cases.....
1.64	Mounting blocks.....	1.99	Screw taps.....
1.64	Mounting clamp blocks.....		
1.64	Quick locks.....		

General

Profile group

16 mm, 20 mm, 30 mm, 40 mm, 45 mm, 50 mm, 60 mm

The profiles of the MayTec Profile System are divided into seven **profile groups (PG)**. They can be determined by the basic measure of each profile.

Slot

H-slot, F-slot, E-slot

In order to connect the profiles or to mount accessories the profiles have slots. The MayTec Slot System (↗ 1.02) distinguishes between the three slot types H-slot, F-slot and E-slot, whereas E-slot exists as **E3-slot** and **E4-slot** (3 or 4 mm wall thickness).

Symbols

Many articles (fastening elements, accessories and tools) can only be used especially for individual profile groups or slot types. In this case these articles are marked with the corresponding symbols.



**Profile group**

dark symbol: suitable for the corresponding profile group  
light symbol: not suitable

**Slot type**

dark symbol: suitable for the corresponding slot type  
light symbol: not suitable

**Remark**

The symbol for the E-slot is used, if the article is (un)suitable for the two slot types E3 and E4.



**Cut**

These articles are offered with cut.



**Stainless steel**

These articles are made of stainless steel.



**Cleanroom**

These articles are suitable for the use in and around cleanrooms.



**ESD**

ESD protection



**Attention!**







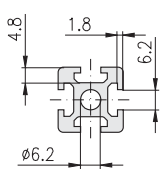
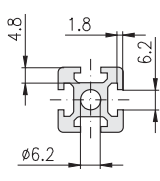

Important notice

Abbreviations

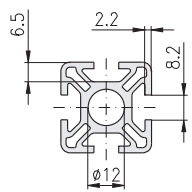
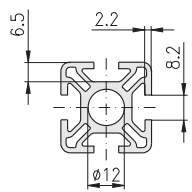
PG	<b>profile group</b>	e.g.: PG 30 = profile group 30 mm
L	<b>light</b>	profile characteristic: light type of construction
S	<b>heavy</b>	profile characteristic: heavy type of construction
P	<b>plain</b>	profile characteristic: no ornamental slots

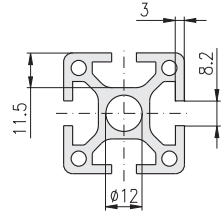
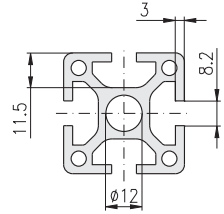
Special characters

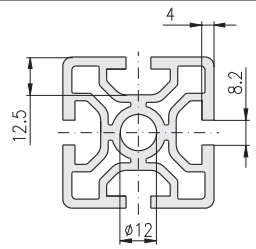
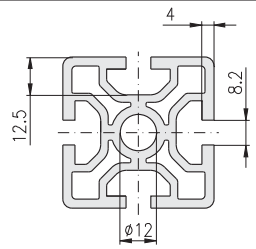
<input type="checkbox"/>	<b>Placeholder</b> Article-No.	<b>Example</b> 1.41.5□□□□	<b>identifies the articles:</b> 1.41.5F0.1 1.41.5F0.2 1.41.5E0.1 1.41.5E0.2
↗	<b>Reference</b>	<b>Example</b> ↗ 117 ↗ 1.41 ↗ 1.41.5F0.1 ↗ 1.41.5□□□□	<b>reference to</b> catalogue page 117 article number group 1.41 article 1.41.5F0.1 group of articles 1.41.5□□□□

Cross section of slots		Core hole-Ø	Slot width	Slot depth	Wall thickness	PG	
<b>H-slot</b>  		6.2	6.2	4.8	1.8	20	
							
<b>F-slot</b>  		12.0	8.2	6.5	2.2	20	
							
<b>E3-slot</b>  		12.0	8.2	11.5	3.0	40	
							
<b>E4-slot</b>  		12.0	8.2	12.5	4.0	45	
							
							



Profiles

1. 1 □ . □□□□□□ . □□□□□□	<b>Key</b>
1. 1 □ . □□□□□□ . □□□□□□	Core hole-Ø <sup>1)</sup>
1. 1 □ . □□□□□□ . □□□□□□	Profile width
1. 1 □ . □□□□□□ . □□□□□□	Profile height (all, but special profiles)
1. 1 □ . □□□ R □□ . □□□□□□	Number of degrees (round profiles)
1. 1 □ . □□□□ k t . □□□□□□	Number of edges (special profiles)
1. 1 □ . □□□□□□ . □□□□□□	Slot quantity <sup>2)</sup>
1. 1 □ . □□□□□□ . □□□□□□	Contour <sup>3)</sup>
1. 1 □ . □□□□□□ . □□ L	Version light
1. 1 □ . □□□□□□ . □□ S	Version heavy
1. 1 □ . □□□□□□ . □□ B	Type B
1. 1 □ . □□□□□□ . □□ L B	Version light, Type B
1. 1 □ . □□□□□□ . □□ P	Plain

- <sup>1)</sup> 0 = 6.2 mm  
1 = 12 mm
- <sup>2)</sup> 2-digit off 10 slots
- <sup>3)</sup> 0 = round  
1 = Soft  
2 = Corner  
3 = Cubic  
4 = Rectangle  
7 = Angle  
8 = Angle 45°  
9 = Special

Connectors  
- general

1. 2 □ . □□□□□□	<b>Key</b>
1. 2 □ . □□□□□□	Core hole <sup>1)</sup>
1. 2 □ . □□□□□□	Profile width <sup>2)</sup>
1. 2 □ . □□□□□□	Head-variant <sup>3)</sup>
1. 2 □ . □□□□□□	Connection-variant <sup>4)</sup>
1. 2 □ . □□□ V □□	Stainless
1. 2 □ . □□□□ E	Ground

**Special cases:** Parallel-connector across and high  
Profile width for cross bushing  
Profile width for anchor

- <sup>1)</sup> 0 = 6.2 mm  
1 = 12 mm
- <sup>2)</sup> 2 = 20 mm  
3 = 30 mm  
4 = 40 mm  
45 = 45 mm  
5 = 50 mm  
6 = 60 mm
- <sup>3)</sup> E = E-head  
F = F-head  
H = H-head  
V = Extension
- <sup>4)</sup> 0 = Universal / Neutral  
1 = Standard  
2 = Standard 90°  
4 = Square head  
5 = Parallel

-Oblique-hinge

1. 2 □ . □□□□□□	<b>Key</b>
1. 2 □ . □□ K □□	Oblique-connector, hinge
1. 2 □ . □□□□□□	Connection-variant <sup>1)</sup>
1. 2 □ . □□□□ V	Stainless

- <sup>1)</sup> 1 = Standard  
2 = Standard 90°

-Oblique-bent anchor

1. 2 □ . □□□□□□ / □□□□	<b>Key</b>
1. 2 □ . □□ B □□ / □□□□	Oblique-connector, bent anchor
1. 2 □ . □□□□□□ / □□□□	Connection-variant <sup>1)</sup>
1. 2 □ . □□□□□□ / □□□□	Design L/R
1. 2 □ . □□□□□□ / □□□□	Angle
1. 2 □ . □□□□□□ / □□ V □	Stainless
1. 2 □ . □□□□□□ / □□□ E	Ground

- <sup>1)</sup> 1 = Standard  
2 = Standard 90°

-Miter-hinge

1. 2 □ . □□□□□□	<b>Key</b>
1. 2 □ . □ G □□	Miter-connector, hinge
1. 2 □ . □□□□□□	Connection-variant <sup>1)</sup>
1. 2 □ . □□□□ V	Stainless

- <sup>1)</sup> 1 = Standard  
2 = Standard 90°

-Miter-bent anchor

1. 2 □ . □□□□□□ / □□□□	<b>Key</b>
1. 2 □ . □ G □□ / □□□□	Miter-connector
1. 2 □ . □□ B □ / □□□□	Bent design
1. 2 □ . □□□□□□ / □□□□	Connection-variant <sup>1)</sup>
1. 2 □ . □□□□□□ / □□□□	Angle
1. 2 □ . □□□□□□ / □□ V	Stainless

- <sup>1)</sup> 1 = Standard  
2 = Standard 90°

-Screw-type

1. 2 □ . □□□□□□ / □□	<b>Key</b>
1. 2 □ . □ S □□□□ / □□	Screw-type-connector
1. 2 □ . □□□□□□ / □□	Type of anchor <sup>1)</sup>
1. 2 □ . □□□□ M □ / □□	Thread
1. 2 □ . □□□□□□ / □□	Thread-Ø
1. 2 □ . □□□□□□ / □□	Screw special length

- <sup>1)</sup> 1 = Standard  
2 = Parallel 20 mm  
3 = Parallel 30 mm  
4 = Parallel 40 mm  
5 = Parallel 50 mm

**Special cases:** Screw-type connector parallel across and high  
Profile width for cross bushing  
Profile width for anchor

	plain	plain	plain	plain
16	<p>16x40</p> <p>L</p> <p>S</p> <p>1FLP</p> <p>14</p>	<p>16x40 16x80 16x160</p> <p>L</p> <p>S</p> <p>1ELP 2ELP 4ELP 1ESP 2ESP</p> <p>13</p>		
20	<p>20x20</p> <p>L</p> <p>S</p> <p>2HLP 4HLP 2Hs.SP 2Hc.SP 3HSP 4HSP</p> <p>15</p>	<p>20x40</p> <p>L</p> <p>S</p> <p>6HLP 4HSP 6HSP</p> <p>16</p>	<p>20x10 20x30</p> <p>L</p> <p>S</p> <p>1FLP 1FLP 2FLP 1FSBP 2FSP</p> <p>17</p>	
30	<p>30x30 30x50 30x60 30x100 30x150</p> <p>L</p> <p>S</p> <p>1FLP 2Fc.LP 2FLP 3FLP 4FLP 4FLP 2Fs.SP 0FSP 1FSP 2Fc.SP 2Fc.SBP 2FSP 3FSP 4FSP 4FSP 0FSP 6FSP 3FSP 8FSP 10FSP 8FSBP</p> <p>18 19 20 21</p>	<p>30x150</p> <p>L</p> <p>S</p> <p>8ESP</p> <p>21</p>		
40	<p>E3 40x40 40x80 40x120 40x160 80x80</p> <p>L</p> <p>S</p> <p>2Es.LP 1ELP 2Ec.LP 2ELP 3ELP 4ELP 0ELP 3Ec.LP 4ELP 4ELP 5ELP 6ELP 8ELP 6ELP 10ELP 0ELP 4Ec.LP 6ELP 8ELP 2E 40r.30° 40r.45° 40r.60° 40r.90° 2FLP 2ELP 2ELP 2ELP 0ESP 2Ec.SP 3ESP 4ESP 6ESP 2E 45° LP 7E 45° LP 7ESP 8ESP</p> <p>22 / 28 23 / 28 24 25 26 / 29</p>			
45	<p>E4 45x45 45x60 45x90 90x90</p> <p>L</p> <p>S</p> <p>2Es.LP 0ELP 1ELP 2Ec.LP 2ELP 3ELP 4ELP 4ELP 0ELP 6ELP 4ESP 0ESP 6ESP 8ELP 8ESP</p> <p>30 31 32</p>			
50	<p>E4</p> <p>L</p> <p>S</p>			
60	<p>E4 60x60</p> <p>L</p> <p>S</p> <p>2ELP 4ELP 2Ec.SP 2ESP 4ESP</p> <p>34</p>			

plain

plain



without grooves

grooves



with grooves

grooves

16	20	30	40	45	50	60	Profile group
<div style="display: flex; justify-content: space-around;"> <span>H</span> <span>F</span> <span>E</span> </div>							Slot type
<span>plain</span>							plain

L	light
S	heavy
P	plain
B	type B

octag.	octagonal
c.	corner
r.	round
s.	soft
a.	angle

**30**

	<b>F</b>	30x30	30x50	30x60	60x60				
L		2F E.L	2FL	3FL	4FL	4FL	6FL	8FL	
S		2F s.S	2F c.S	2F c.SB	3FS	4FS	4FS	6FS	8F a.S

**40**

	<b>E3</b>	40x40	40x80	40x120	80x80	80x160						
L		2E s.L	2E c.L	2EL	3EL	4EL	4EL	6EL	8EL	8EL	8ELB	12EL
S		2E c.S	3ES	4ES	6ES	8ES	8E a.S	12ES				

**45**

	<b>E4</b>	45x45	45x60	45x90
L		4EL	4EL	6EL
S		4ES	6ES	

**50**

	<b>E4</b>	50x50	50x100	50x150	100x100			
L		2E c.L	2EL	3EL	4EL	6EL	8EL	8EL
S		2E s.S	2E c.S	3ES	4ES	6ES	8ES	8ES

**60**









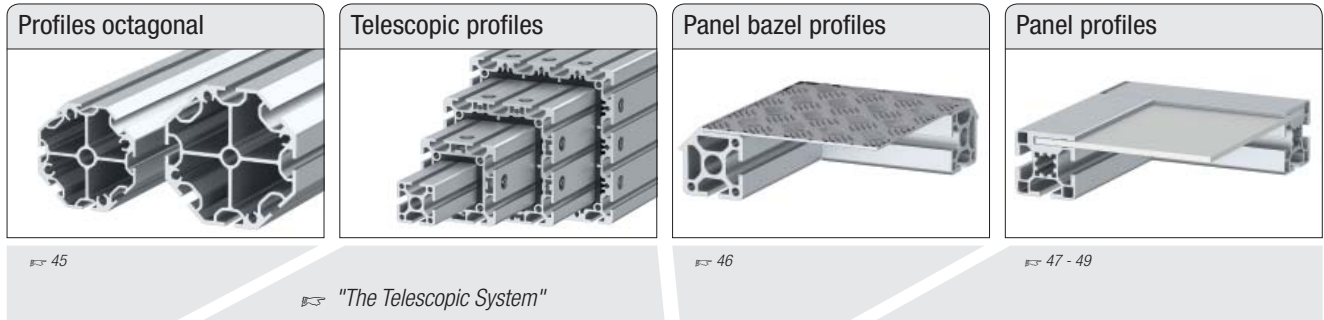

	<b>E4</b>	60x60	60x90
L		4EL	6EL
S		4ES	6ES











80x80	80x120	80x160	120x120
8E LBP	8E LP	12E LP	
8E a.SP	10E SP	8E SP	12E SP
			12E SP



100x200
12E SP



<p>30</p> <p>plain</p>	<p>F 30 octag.</p> <p>L</p> <p>S </p> <p>8F SP</p>		<p>30x60</p> <p></p> <p>3F 45° LP</p>	<p>30x30</p> <p></p> <p>0F LP</p> <p></p> <p>2F c.LP 4</p> <p></p> <p>3FLP 4</p> <p></p> <p>3FLP 4</p> <p></p> <p>2FLP 5</p> <p></p> <p>2FLP 5</p> <p></p> <p>2FLP 6</p>	<p>30x50</p> <p></p> <p>2FLP 5</p> <p></p> <p>2FLP 6</p>
------------------------	---	--	--	---	--

<p>40</p> <p>plain</p>	<p>E3 40 octag.</p> <p>L</p> <p>S </p> <p>8E SP</p>	<p>40x40</p> <p></p> <p>8E SBP</p>	<p>80x80</p> <p></p> <p>12E SP</p>	<p>120x120</p> <p></p> <p>16E SP</p>	<p>160x160</p> <p></p> <p>2E 45° SP</p>	<p>40x40</p> <p></p> <p>2E c.LP 4</p> <p></p> <p>3ELP 4</p>	<p>40x60</p> <p></p> <p>3ELP 4</p>	<p>60x80</p> <p></p> <p>5ELP 4</p> <p></p> <p>6ELP 4</p>
------------------------	--	---	---	---	--	---	---	--



<p>45</p> <p>plain</p>								
------------------------	--	--	--	--	--	--	--	--



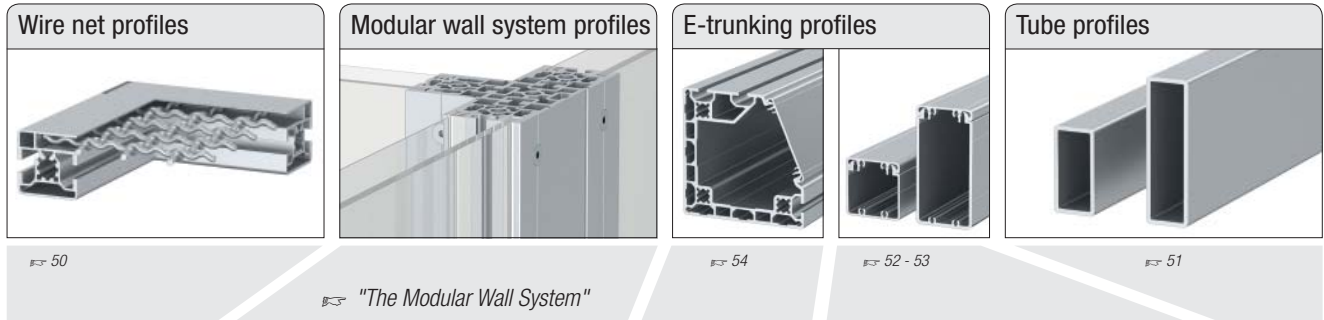

<p>50</p> <p>plain</p>	<p>E4</p> <p>L</p>					<p>50x50</p> <p></p> <p>2E c.LP 4</p> <p></p> <p>3ELP 4</p>		
------------------------	--------------------	--	--	--	--	---	--	--

<p>60</p> <p>plain</p>								
------------------------	--	--	--	--	--	--	--	--

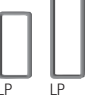

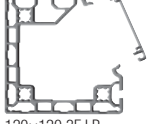

<p>30</p> <p>plain</p> <p>F</p> <p>30x30 30x45</p>  <p>2F LP 7.5 2F LP 7.5</p> <p>L</p> <p>S</p>			<p>Lid 30</p>  <p>30x30</p>	<p>30x60 30x100</p>  <p>LP LP</p>
---	--	--	---	--

<p>40</p> <p>plain</p> <p>E3</p> <p>40x40 40x60</p>  <p>2E LP 7.5 2E 1F LP 7.5</p> <p>L</p> <p>S</p>		<p>120x120</p> <p>Lid 80</p>  <p>120x120 3E LP</p> <p>80x160</p> <p>Profile pre-cut lid 120</p>  <p>80x160 8E SP</p>	<p>Lid 40</p>  <p>40x20 40x20 40x40 40x80</p> <p>for clips</p> <p>Lid 80</p>  <p>Lid 200</p>  <p>80x40 80x80 200x50</p>	
---	--	---	---	--

<p>45</p> <p>plain</p> <p>E4</p> <p>L</p>	<p>45x45</p> <p>Compression profile</p> <p>47.5x5 45x5</p> <p>50x5</p>  <p>2E c.LP 4E LP 1E LP 4E LP</p>			
---	---	--	--	--

<p>50</p> <p>plain</p>				
------------------------	--	--	--	--

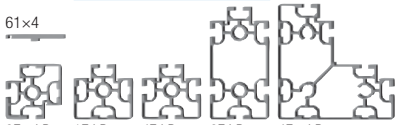
<p>60</p> <p>plain</p> <p>E4</p> <p>L</p>	<p>57x57 60x57 60x117 120x120</p> <p>Compression profile</p> <p>57x4 60x4 60x4 with chamfer</p> <p>61x4</p>  <p>2E c.LP 1E LP 4E LP 6E LP 4E a.LP</p>			
---	--	--	--	--

1

**Profiles round**



48 round

plain



1E SP 2E c.SP 2E SP

↔ 45

**19" profiles**



PG 30 PG 40 PG 50

↔ 55

**Tubes**



020x2 030x3 040x4

↔ 55

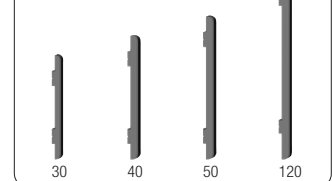

**Profile pre-cut lids**

30 40 50 120

↔ 56

**Wire net mounting profiles**

33x10

↔ 56

**Grab handle profiles**



↔ 56

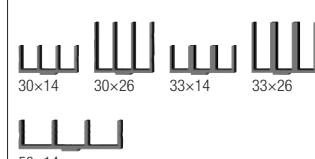

**Sliding profiles**

30x14 30x26 33x14 33x26 50x14

↔ 57

**C-track**





↔ 57



**U-profile**

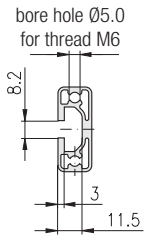



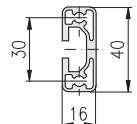
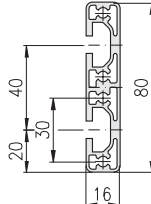
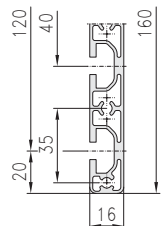

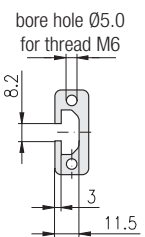
40

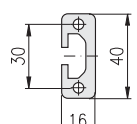
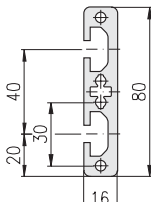
↔ 57

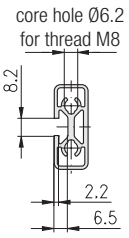

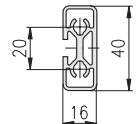
light				
				
				
Description	Profile 16×40, 1E, LP	Profile 16×80, 2E, LP	Profile 16×160, 4E, LP	
bar, 6 m	1.09.016040.14LP.60	1.09.016080.24LP.60	1.09.016160.44LP.60	
packing unit (number)	1.09.016040.14LP.61 (20)	1.09.016080.24LP.61 (10)	1.09.016160.44LP.61 (5)	
moment of inertia cm <sup>4</sup>	$I_x = 4.3$ $I_y = 0.8$	$I_x = 30.7$ $I_y = 1.6$	$I_x = 221.0$ $I_y = 3.2$	
moment of resistance cm <sup>3</sup>	$W_x = 2.2$ $W_y = 0.8$	$W_x = 7.7$ $W_y = 1.6$	$W_x = 27.5$ $W_y = 3.2$	
weight kg/m	$G = 0.75$	$G = 1.49$	$G = 2.6$	





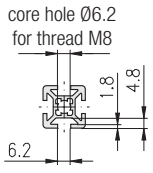

heavy				
				
				
Description	Profile 16×40, 1E, SP	Profile 16×80, 2E, SP		
bar, 6 m	1.09.016040.14SP.60	1.09.016080.24SP.60		
packing unit (number)	1.09.016040.14SP.61 (20)	1.09.016080.24SP.61 (10)		
moment of inertia cm <sup>4</sup>	$I_x = 7.2$ $I_y = 1.1$	$I_x = 48.3$ $I_y = 2.2$		
moment of resistance cm <sup>3</sup>	$W_x = 3.6$ $W_y = 1.1$	$W_x = 12.0$ $W_y = 2.2$		
weight kg/m	$G = 1.14$	$G = 2.11$		

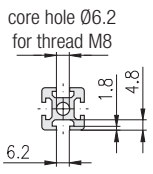

light				
				
				
Description	Profile 16×40, 1F, LP			
bar, 6 m	1.10.016040.14LP.60			
packing unit (number)	1.10.016040.14LP.61 (20)			
moment of inertia cm <sup>4</sup>	$I_x = 4.4$	$I_y = 0.8$		
moment of resistance cm <sup>3</sup>	$W_x = 2.2$	$W_y = 0.8$		
weight kg/m	$G = 0.87$			



heavy				
Description				
bar, 6 m				
packing unit (number)				
moment of inertia cm <sup>4</sup>				
moment of resistance cm <sup>3</sup>				
weight kg/m				



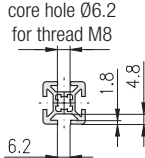

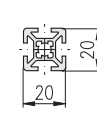
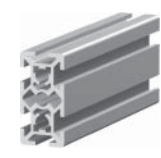
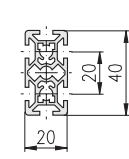

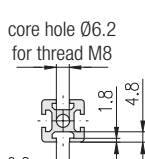

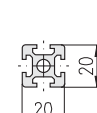
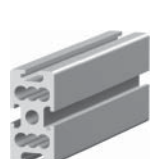
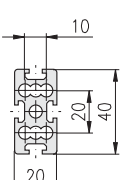
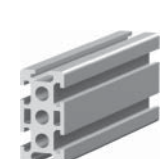
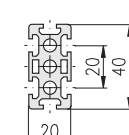
<div style="border: 1px solid black; border-radius: 10px; padding: 2px 10px; display: inline-block;">light</div>				
				
				
Description			Profile 20×20, 2H, LP	
bar, 6 m			1.10.020020.23LP.60	
packing unit (number)			1.10.020020.23LP.61 (10)	
moment of inertia cm <sup>4</sup>			$I_x = 1.0$ $I_y = 0.8$	
moment of resistance cm <sup>3</sup>			$W_x = 1.0$ $W_y = 0.8$	
weight kg/m			$G = 0.58$	

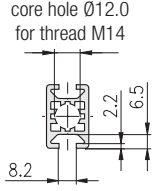

<div style="border: 1px solid black; border-radius: 10px; padding: 2px 10px; display: inline-block;">heavy</div>				
				
				
Description	Profile 20×20, 2H, soft, SP	Profile 20×20, 2H, corner, SP		Profile 20×20, 3H, SP
bar, 6 m	1.10.020020.21SP.60	1.10.020020.22SP.60		1.10.020020.33SP.60
packing unit (number)	1.10.020020.21SP.61 (10)	1.10.020020.22SP.61 (10)		1.10.020020.33SP.61 (10)
moment of inertia cm <sup>4</sup>	$I_x = 0.6$ $I_y = 0.6$	$I_x = 1.0$ $I_y = 1.0$		$I_x = 0.9$ $I_y = 0.9$
moment of resistance cm <sup>3</sup>	$W_x = 0.6$ $W_y = 0.6$	$W_x = 0.9$ $W_y = 0.9$		$W_x = 0.9$ $W_y = 0.9$
weight kg/m	$G = 0.52$	$G = 0.68$		$G = 0.65$

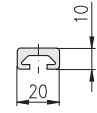
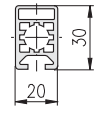
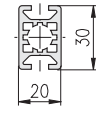

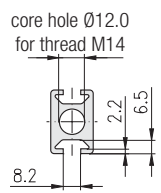
light				
	  		  	
Description	Profile 20×20, 4H, LP		Profile 20×40, 6H, LP	
bar, 6 m	1.10.020020.43LP.60		1.10.020040.64LP.60	
packing unit (number)	1.10.020020.43LP.61 (10)		1.10.020040.64LP.61 (10)	
moment of inertia cm <sup>4</sup>	$I_x = 0.8$ $I_y = 0.8$		$I_x = 5.3$ $I_y = 1.4$	
moment of resistance cm <sup>3</sup>	$W_x = 0.8$ $W_y = 0.8$		$W_x = 2.6$ $W_y = 1.4$	
weight kg/m	$G = 0.53$		$G = 0.9$	

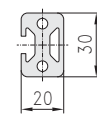
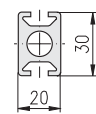
heavy				
	  	  	  	
Description	Profile 20×20, 4H, SP	Profile 20×40, 4H, SP	Profile 20×40, 6H, SP	
bar, 6 m	1.10.020020.43SP.60	1.10.020040.44SP.60	1.10.020040.64SP.60	
packing unit (number)	1.10.020020.43SP.61 (10)	1.10.020040.44SP.61 (10)	1.10.020040.64SP.61 (10)	
moment of inertia cm <sup>4</sup>	$I_x = 0.9$ $I_y = 0.9$	$I_x = 7.0$ $I_y = 2.0$	$I_x = 6.4$ $I_y = 1.7$	
moment of resistance cm <sup>3</sup>	$W_x = 0.9$ $W_y = 0.9$	$W_x = 3.5$ $W_y = 2.0$	$W_x = 3.2$ $W_y = 1.7$	
weight kg/m	$G = 0.62$	$G = 1.3$	$G = 1.3$	

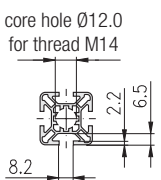

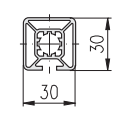

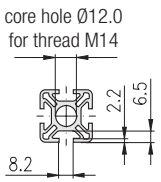

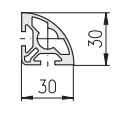
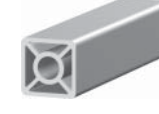
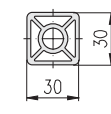
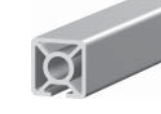
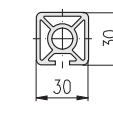
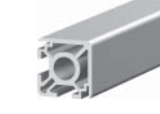
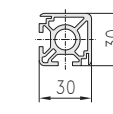
light				
				
				
Description	Profile 20×10, 1F, LP	Profile 20×30, 1F, LP		Profile 20×30, 2F, LP
bar, 6 m	1.11.020010.14LP.60	1.11.020030.14LP.60		1.11.020030.24LP.60
packing unit (number)	1.11.020010.14LP.61 (10)	1.11.020030.14LP.61 (10)		1.11.020030.24LP.61 (10)
moment of inertia cm <sup>4</sup>	$I_x = 0.1$ $I_y = 0.6$	$I_x = 2.2$ $I_y = 1.4$		$I_x = 2.2$ $I_y = 1.5$
moment of resistance cm <sup>3</sup>	$W_x = 0.2$ $W_y = 0.5$	$W_x = 1.5$ $W_y = 1.4$		$W_x = 1.5$ $W_y = 1.5$
weight kg/m	$G = 0.35$	$G = 0.7$		$G = 0.74$





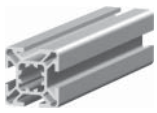
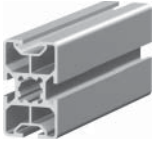

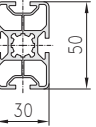

heavy				
				
				
Description			Profile 20×30, 1F, SBP	Profile 20×30, 2F, SP
bar, 6 m			1.11.020030.14SBP.60	1.11.020030.24SP.60
packing unit (number)			1.11.020030.14SBP.61(10)	1.11.020030.24SP.61 (10)
moment of inertia cm <sup>4</sup>			$I_x = 3.9$ $I_y = 1.4$	$I_x = 2.6$ $I_y = 1.9$
moment of resistance cm <sup>3</sup>			$W_x = 2.6$ $W_y = 1.3$	$W_x = 1.7$ $W_y = 1.7$
weight kg/m			$G = 1.2$	$G = 1.0$

<p>light</p> 			  	
Description			Profile 30×30, 1F, LP	
bar, 6 m			1.11.030030.13LP.60	
packing unit (number)			1.11.030030.13LP.61 (10)	
moment of inertia	cm <sup>4</sup>		$I_x = 3.1$	$I_y = 3.1$
moment of resistance	cm <sup>3</sup>		$W_x = 2.1$	$W_y = 2.1$
weight	kg/m		$G = 0.9$	



<p>heavy</p> 		  	  	  	  
Description		Profile 30×30, 2F, soft, SP	Profile 30×30, 0F, SP	Profile 30×30, 1F, SP	Profile 30×30, 2F, corner, SP
bar, 6 m		1.11.030030.21SP.60	1.11.030030.03SP.60	1.11.030030.13SP.60	1.11.030030.22SP.60
packing unit (number)		1.11.030030.21SP.61 (10)	1.11.030030.03SP.61 (10)	1.11.030030.13SP.61 (10)	1.11.030030.22SP.61 (10)
moment of inertia	cm <sup>4</sup>	$I_x = 2.7$	$I_x = 4.4$	$I_x = 4.3$	$I_x = 3.7$
		$I_y = 2.7$	$I_y = 4.4$	$I_y = 4.0$	$I_y = 3.2$
moment of resistance	cm <sup>3</sup>	$W_x = 1.6$	$W_x = 2.3$	$W_x = 2.9$	$W_x = 2.4$
		$W_y = 1.6$	$W_y = 2.3$	$W_y = 2.6$	$W_y = 2.1$
weight	kg/m	$G = 0.9$	$G = 1.3$	$G = 1.2$	$G = 1.1$



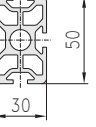

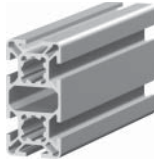
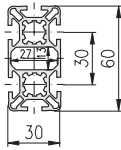
				
				
Profile 30×30, 2F, corner, LP	Profile 30×30, 2F, LP	Profile 30×30, 3F, LP	Profile 30×30, 4F, LP	Profile 30×50, 4F, LP
1.11.030030.22LP.60	1.11.030030.23LP.60	1.11.030030.33LP.60	1.11.030030.43LP.60	1.11.030050.44LP.60
1.11.030030.22LP.61 (10)	1.11.030030.23LP.61 (10)	1.11.030030.33LP.61 (10)	1.11.030030.43LP.61 (10)	1.11.030050.44LP.61 (6)
$I_x = 3.2$ $I_y = 3.2$ $W_x = 2.1$ $W_y = 2.1$ $G = 0.9$	$I_x = 3.2$ $I_y = 3.2$ $W_x = 2.1$ $W_y = 2.1$ $G = 0.9$	$I_x = 3.0$ $I_y = 3.0$ $W_x = 2.0$ $W_y = 2.0$ $G = 0.9$	$I_x = 3.3$ $I_y = 3.3$ $W_x = 2.2$ $W_y = 2.2$ $G = 0.9$	$I_x = 10.6$ $I_y = 4.7$ $W_x = 4.6$ $W_y = 3.6$ $G = 1.3$

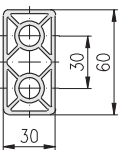
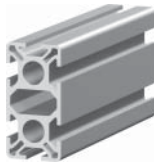
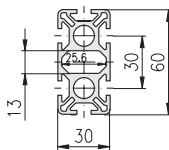
				
				
Profile 30×30, 2F, corner, SBP	Profile 30×30, 2F, SP	Profile 30×30, 3F, SP	Profile 30×30, 4F, SP	Profile 30×50, 4F, SP
1.11.030030.22SBP.60	1.11.030030.23SP.60	1.11.030030.33SP.60	1.11.030030.43SP.60	1.11.030050.44SP.60
1.11.030030.22SBP.61(10)	1.11.030030.23SP.61 (10)	1.11.030030.33SP.61 (10)	1.11.030030.43SP.61 (10)	1.11.030050.44SP.61 (6)
$I_x = 3.7$ $I_y = 3.7$ $W_x = 2.4$ $W_y = 2.4$ $G = 1.1$	$I_x = 3.6$ $I_y = 3.9$ $W_x = 2.4$ $W_y = 2.6$ $G = 1.1$	$I_x = 3.5$ $I_y = 3.7$ $W_x = 2.4$ $W_y = 2.4$ $G = 1.1$	$I_x = 3.5$ $I_y = 3.5$ $W_x = 2.4$ $W_y = 2.4$ $G = 1.1$	$I_x = 16.3$ $I_y = 6.4$ $W_x = 6.5$ $W_y = 4.3$ $G = 1.9$

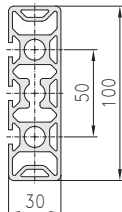
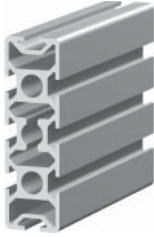
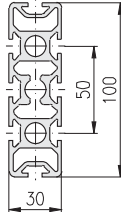
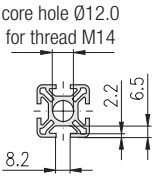

light		 		
Description		Profile 30×60, 6F, LP		
bar, 6 m		1.11.030060.64LP.60		
packing unit (number)		1.11.030060.64LP.61 (6)		
moment of inertia cm <sup>4</sup>		$I_x = 21.1$ $I_y = 5.9$		
moment of resistance cm <sup>3</sup>		$W_x = 7.4$ $W_y = 3.9$		
weight kg/m		$G = 1.6$		

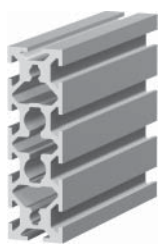
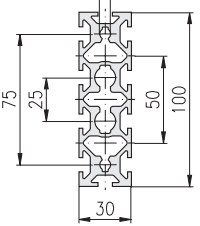
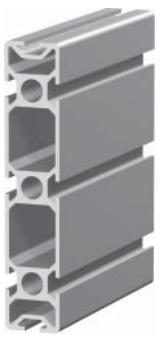
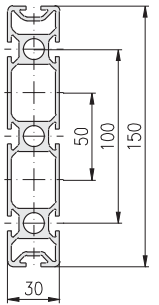
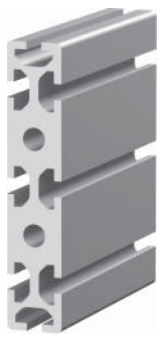
heavy	 	 	 	 	
core hole Ø12.0 for thread M14 	Description	Profile 30×60 0F, SP	Profile 30×60 6F, SP	Profile 30×100, 3F, SP	Profile 30×100, 8F, SP
bar, 6 m	1.11.030060.04SP.60	1.11.030060.65SP.60	1.11.030100.34SP.60	1.11.030100.84SP.60	
packing unit (number)	1.11.030060.04SP.61 (6)	1.11.030060.65SP.61 (6)	1.11.030100.34SP.61 (4)	1.11.030100.84SP.61 (4)	
moment of inertia cm <sup>4</sup>	$I_x = 29.0$ $I_y = 7.8$	$I_x = 25.0$ $I_y = 7.0$	$I_x = 120.4$ $I_y = 12.8$	$I_x = 115.0$ $I_y = 11.6$	
moment of resistance cm <sup>3</sup>	$W_x = 9.6$ $W_y = 5.2$	$W_x = 8.3$ $W_y = 4.7$	$W_x = 24.0$ $W_y = 8.5$	$W_x = 22.9$ $W_y = 7.7$	
weight kg/m	$G = 2.2$	$G = 2.1$	$G = 3.6$	$G = 3.4$	

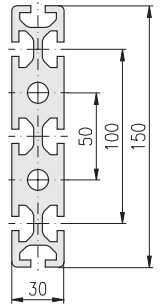
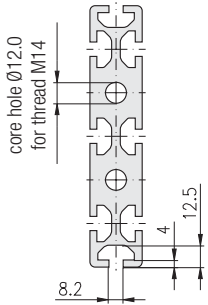

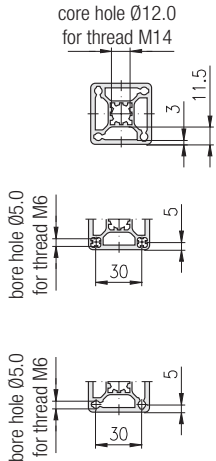
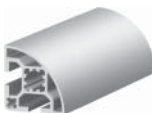
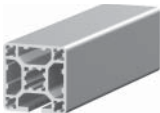
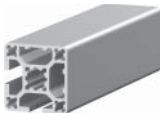

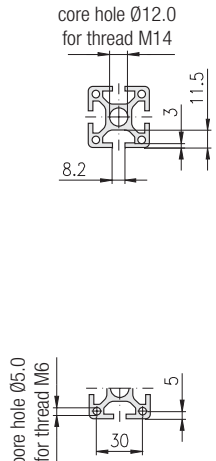
1

 <p>core hole Ø6,2 for thread M8</p> 		 	 <p>Connection possibilities   110, Universal connector   114, ST-Connector</p>  
<p>Profile 30×100, 10F, SP</p>		<p>Profile 30×150, 8F, SBP</p>	<p>Profile 30×150, 8E, SP</p>
<p>1.11.030100.104SP.60</p>		<p>1.11.030150.84SBP.60</p>	<p>1.11.030150.84SP.60</p>
<p>1.11.030100.104SP.61 (4)</p>		<p>1.11.030150.84SBP.61 (2)</p>	<p>1.11.030150.84SP.61 (2)</p>
<p><math>I_x = 127.0</math> <math>I_y = 11.9</math>  <math>W_x = 25.4</math> <math>W_y = 7.9</math>  <math>G = 3.6</math></p>		<p><math>I_x = 340.0</math> <math>I_y = 16.0</math>  <math>W_x = 45.0</math> <math>W_y = 11.0</math>  <math>G = 4.1</math></p>	<p><math>I_x = 481.0</math> <math>I_y = 25.1</math>  <math>W_x = 64.1</math> <math>W_y = 16.7</math>  <math>G = 7.9</math></p>

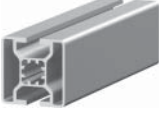
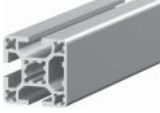
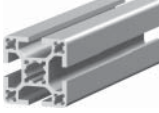
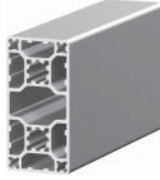
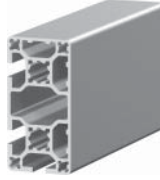
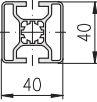
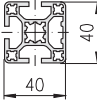
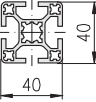
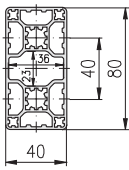
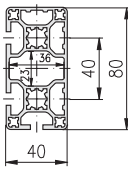
<b>light</b>				
				
Description	Profile 40×40, 2E, soft, LP		Profile 40×40, 1E, LP	Profile 40×40, 2E, corner, LP
bar, 6 m	1.11.040040.21LP.60		1.11.040040.13LP.60	1.11.040040.22LP.60
packing unit (number)	1.11.040040.21LP.61 (8)		1.11.040040.13LP.61 (8)	1.11.040040.22LP.61 (8)
moment of inertia cm <sup>4</sup>	$I_x = 6.4$ $I_y = 6.4$		$I_x = 10.1$ $I_y = 9.8$	$I_x = 9.9$ $I_y = 9.9$
moment of resistance cm <sup>3</sup>	$W_x = 3.8$ $W_y = 3.8$		$W_x = 5.0$ $W_y = 4.8$	$W_x = 4.9$ $W_y = 4.9$
weight kg/m	$G = 1.2$		$G = 1.5$	$G = 1.5$

<b>heavy</b>				
				
Description	Profile 40×40, 0E, SP		Profile 40×40, 2E, corner, SP	
bar, 6 m	1.11.040040.03SP.60		1.11.040040.22SP.60	
packing unit (number)	1.11.040040.03SP.61 (8)		1.11.040040.22SP.61 (8)	
moment of inertia cm <sup>4</sup>	$I_x = 12.6$ $I_y = 12.6$		$I_x = 12.0$ $I_y = 12.0$	
moment of resistance cm <sup>3</sup>	$W_x = 6.3$ $W_y = 6.3$		$W_x = 6.0$ $W_y = 6.0$	
weight kg/m	$G = 2.0$		$G = 2.0$	

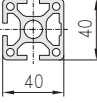
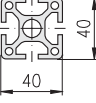
				
				
Profile 40×40, 2E, LP	Profile 40×40, 3E, LP	Profile 40×40, 4E, LP	Profile 40×80, 0E, LP	Profile 40×80, 3E, corner, LP
1.11.040040.23LP.60	1.11.040040.33LP.60	1.11.040040.43LP.60	1.11.040080.04LP.60	1.11.040080.32LP.60
1.11.040040.23LP.61 (8)	1.11.040040.33LP.61 (8)	1.11.040040.43LP.61 (8)	1.11.040080.04LP.61 (4)	1.11.040080.32LP.61 (4)
$I_x = 8.2$ $I_y = 7.5$ $W_x = 4.1$ $W_y = 3.8$ $G = 1.3$	$I_x = 9.5$ $I_y = 9.9$ $W_x = 4.7$ $W_y = 4.9$ $G = 1.5$	$I_x = 9.6$ $I_y = 9.6$ $W_x = 4.7$ $W_y = 4.7$ $G = 1.5$	$I_x = 66.8$ $I_y = 18.4$ $W_x = 16.7$ $W_y = 9.2$ $G = 2.7$	$I_x = 66.9$ $I_y = 18.1$ $W_x = 16.7$ $W_y = 9.0$ $G = 2.6$

				
				
	Profile 40×40, 3E, SP	Profile 40×40, 4E, SP		
	1.11.040040.33SP.60	1.11.040040.43SP.60		
	1.11.040040.33SP.61 (8)	1.11.040040.43SP.61 (8)		
	$I_x = 12.0$ $I_y = 11.4$ $W_x = 6.0$ $W_y = 5.6$ $G = 2.0$	$I_x = 12.0$ $I_y = 12.0$ $W_x = 6.0$ $W_y = 6.0$ $G = 2.0$		

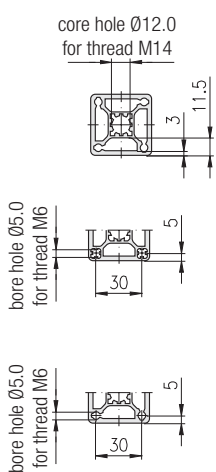
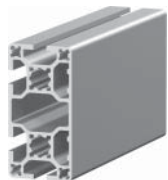
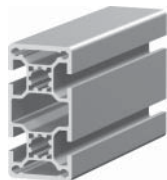
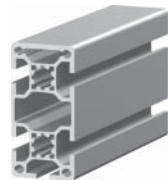
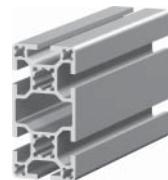
<b>light</b>				
				
Description	Profile 40×80, 4E, LP	Profile 40×80, 4E, LBP	Profile 40×80, 5E, LP	Profile 40×80, 6E, LP
bar, 6 m	1.11.040080.44LP.60	1.11.040080.44LBP.60	1.11.040080.54LP.60	1.11.040080.64LP.60
packing unit (number)	1.11.040080.44LP.61 (4)	1.11.040080.44LBP.61 (4)	1.11.040080.54LP.61 (4)	1.11.040080.64LP.61 (4)
moment of inertia cm <sup>4</sup>	$I_x = 65.8$ $I_y = 18.1$	$I_x = 74.5$ $I_y = 18.3$	$I_x = 72.2$ $I_y = 18.1$	$I_x = 65.4$ $I_y = 17.5$
moment of resistance cm <sup>3</sup>	$W_x = 16.5$ $W_y = 9.0$	$W_x = 18.6$ $W_y = 9.2$	$W_x = 18.0$ $W_y = 9.0$	$W_x = 16.4$ $W_y = 8.8$
weight kg/m	$G = 2.6$	$G = 2.8$	$G = 2.8$	$G = 2.5$

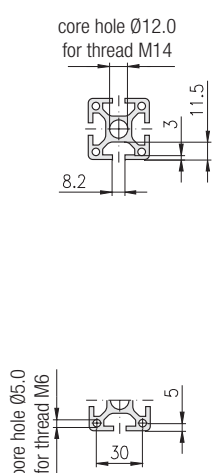
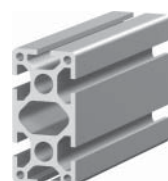
<b>heavy</b>				
				
Description				Profile 40×80, 6E, SP
bar, 6 m				1.11.040080.64SP.60
packing unit (number)				1.11.040080.64SP.61 (4)
moment of inertia cm <sup>4</sup>				$I_x = 82.0$ $I_y = 23.4$
moment of resistance cm <sup>3</sup>				$W_x = 20.5$ $W_y = 11.7$
weight kg/m				$G = 3.8$

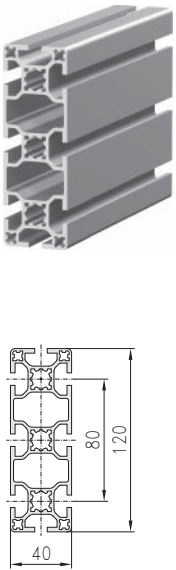
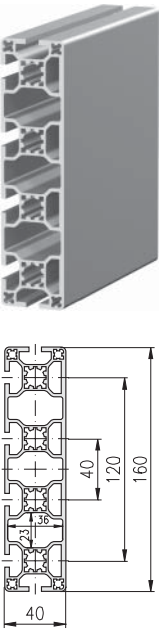
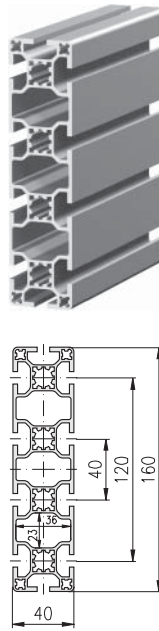
				
<p>Profile 40×120, 8E, LP</p>	<p>Profile 40×160, 6E, LP</p>	<p>Profile 40×160, 10E, LP</p>		
<p>1.11.040120.84LP.60</p>	<p>1.11.040160.64LP.60</p>	<p>1.11.040160.104LP.60</p>		
<p>1.11.040120.84LP.61 (2)</p>	<p>1.11.040160.64LP.61 (2)</p>	<p>1.11.040160.104LP.61 (2)</p>		
<p><math>I_x = 200.4</math> <math>I_y = 25.4</math> <math>W_x = 33.4</math> <math>W_y = 12.7</math> <math>G = 3.8</math></p>	<p><math>I_x = 450.4</math> <math>I_y = 36.3</math> <math>W_x = 56.3</math> <math>W_y = 18.1</math> <math>G = 5.0</math></p>	<p><math>I_x = 433.5</math> <math>I_y = 33.1</math> <math>W_x = 54.2</math> <math>W_y = 16.5</math> <math>G = 4.7</math></p>		





light				
Description	Profile 80×80, OE, LP	Profile 80×80, 4E, corner, LP	Profile 80×80, 6E, LP	Profile 80×80, 8E, LP
bar, 6 m	1.11.080080.03LP.60	1.11.080080.42LP.60	1.11.080080.63LP.60	1.11.080080.83LP.60
packing unit (number)	1.11.080080.03LP.61 (2)	1.11.080080.42LP.61 (2)	1.11.080080.63LP.61 (2)	1.11.080080.83LP.61 (2)
moment of inertia cm <sup>4</sup>	$I_x = 135.0$ $I_y = 135.0$	$I_x = 128.0$ $I_y = 128.0$	$I_x = 121.3$ $I_y = 116.0$	$I_x = 114.0$ $I_y = 114.0$
moment of resistance cm <sup>3</sup>	$W_x = 33.5$ $W_y = 33.5$	$W_x = 32.0$ $W_y = 32.0$	$W_x = 30.3$ $W_y = 29.0$	$W_x = 28.4$ $W_y = 28.4$
weight kg/m	$G = 4.7$	$G = 4.5$	$G = 4.2$	$G = 4.1$

heavy				
Description		Profile 80×80, 7E, SP	Profile 80×80, 8E, SP	
bar, 6 m		1.11.080080.79SP.60	1.11.080080.83SP.60	
packing unit (number)		1.11.080080.79SP.61 (2)	1.11.080080.83SP.61 (2)	
moment of inertia cm <sup>4</sup>		$I_x = 162.8$ $I_y = 149.7$	$I_x = 166.0$ $I_y = 166.0$	
moment of resistance cm <sup>3</sup>		$W_x = 40.7$ $W_y = 37.5$	$W_x = 41.4$ $W_y = 41.4$	
weight kg/m		$G = 6.2$	$G = 5.9$	

Profile 80×80, 8E, LBP		Profile 80×160, 8E, LP	Profile 80×160, 12E, LP	
1.11.080080.83LP.60		1.11.080160.84LP.60	1.11.080160.124LP.60	
1.11.080080.83LP.61 (2)		1.11.080160.84LP.61 (2)	1.11.080160.124LP.61 (2)	
$I_x = 118.7$ $I_y = 118.7$ $W_x = 29.9$ $W_y = 29.9$ $G = 4.9$		$I_x = 828.0$ $I_y = 259.0$ $W_x = 104.0$ $W_y = 65.0$ $G = 8.6$	$I_x = 787.6$ $I_y = 231.9$ $W_x = 98.3$ $W_y = 58.2$ $G = 8.2$	

Profile 80×80, 8E, angle, SP	Profile 80×120, 10E, SP	Profile 80×160, 8E, SP	Profile 80×160, 12E, SP	Profile 120×120, 12E, SP
1.11.080080.87SP.60	1.11.080120.104SP.60	1.11.080160.89SP.60	1.11.080160.124SP.60	1.11.120120.123SP.60
1.11.080080.87SP.60 (2)	1.11.080120.104SP.61 (2)	1.11.080160.89SP.61 (2)	1.11.080160.124SP.61 (2)	1.11.120120.123SP.61 (2)
$I_x = 120.0$ $I_y = 120.0$ $W_x = 23.8$ $W_y = 23.8$ $G = 5.4$	$I_x = 449.9$ $I_y = 217.8$ $W_x = 72.6$ $W_y = 54.4$ $G = 8.6$	$I_x = 944.0$ $I_y = 183.0$ $W_x = 118.0$ $W_y = 45.8$ $G = 7.9$	$I_x = 883.0$ $I_y = 269.0$ $W_x = 110.0$ $W_y = 67.3$ $G = 9.4$	$I_x = 624.0$ $I_y = 624.0$ $W_x = 104.0$ $W_y = 104.0$ $G = 10.6$

light	<b>F-Slot</b>			Connection possibilities and calculation formulas for polygons <a href="#">↗ 1.2E</a>
<b>F-Slot</b>				
core hole $\varnothing 12.0$ for thread M14 				
<b>E3-Slot</b>				
core hole $\varnothing 12.0$ for thread M14 				
Description	Profile 40, round 30 deg., 2F, LP	Profile 40, round 45 deg., 2E, LP	Profile 40, round 60 deg., 2E, LP	
bar, 6 m	1.11.040R30.20LP.60	1.11.040R45.20LP.60	1.11.040R60.20LP.60	
packing unit (number)	1.11.040R30.20LP.61 (8)	1.11.040R45.20LP.61 (8)	1.11.040R60.20LP.61 (8)	
moment of inertia $\text{cm}^4$	$I_x = 6.0$ $I_y = 4.8$	$I_x = 14.5$ $I_y = 8.0$	$I_x = 30.0$ $I_y = 10.5$	
moment of resistance $\text{cm}^3$	$W_x = 3.0$ $W_y = 2.4$	$W_x = 4.9$ $W_y = 3.7$	$W_x = 7.6$ $W_y = 4.6$	
weight $\text{kg/m}$	$G = 1.2$	$G = 1.6$	$G = 1.9$	

light			Connection possibilities and calculation formulas for polygons <a href="#">↗ 1.2E</a>	
core hole $\varnothing 12.0$ for thread M14 				
Description	Profile 40, round 90 deg., 2E, LP			
bar, 6 m	1.11.040R90.20LP.60			
packing unit (number)	1.11.040R90.20LP.61 (4)			
moment of inertia $\text{cm}^4$	$I_x = 89.0$ $I_y = 89.0$			
moment of resistance $\text{cm}^3$	$W_x = 16.0$ $W_y = 16.0$			
weight $\text{kg/m}$	$G = 3.0$			

light				
Description	Profile 40×40, 2E, 45 deg., LP	Profile 80×80, 7E, 45 deg., LP		
bar, 6 m	1.11.040040.28LP.60	1.11.080080.78LP.60		
packing unit (number)	1.11.040040.28LP.61 (8)	1.11.080080.78LP.61 (2)		
moment of inertia cm <sup>4</sup>	$I_x = 7.3$ $I_y = 7.3$	$I_x = 99.3$ $I_y = 99.3$		
moment of resistance cm <sup>3</sup>	$W_x = 3.9$ $W_y = 3.9$	$W_x = 24.8$ $W_y = 24.8$		
weight kg/m	$G = 1.4$	$G = 4.0$		



light				

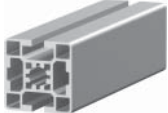
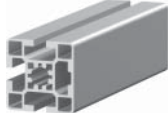
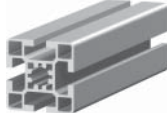
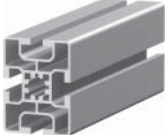
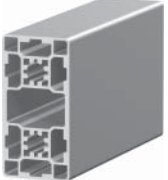
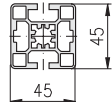
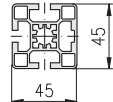
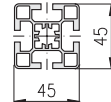
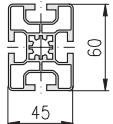
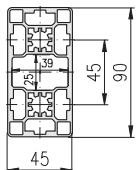

light				
Description	Profile 45×45, 2E, soft, LP	Profile 45×45, 0E, LP	Profile 45×45, 1E, LP	Profile 45×45, 2E, corner, LP
bar, 6 m	1.11.045045.21LP.60	1.11.045045.03LP.60	1.11.045045.13LP.60	1.11.045045.22LP.60
packing unit (number)	1.11.045045.21LP.61 (8)	1.11.045045.03LP.61 (8)	1.11.045045.13LP.61 (8)	1.11.045045.22LP.61 (8)
moment of inertia cm <sup>4</sup>	$I_x = 11.4$ $I_y = 11.4$	$I_x = 15.5$ $I_y = 15.5$	$I_x = 14.7$ $I_y = 15.5$	$I_x = 14.7$ $I_y = 14.7$
moment of resistance cm <sup>3</sup>	$W_x = 5.1$ $W_y = 5.1$	$W_x = 6.9$ $W_y = 6.9$	$W_x = 6.5$ $W_y = 6.8$	$W_x = 6.6$ $W_y = 6.6$
weight kg/m	G = 1.6	G = 2.2	G = 2.1	G = 2.0

heavy				
Description				
bar, 6 m				
packing unit (number)				
moment of inertia cm <sup>4</sup>				
moment of resistance cm <sup>3</sup>				
weight kg/m				

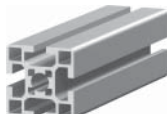
				
				
Profile 45×45, 2E, LP	Profile 45×45, 3E, LP	Profile 45×45, 4E, LP	Profile 45×60, 4E, LP	Profile 45×90, 0E, LP
1.11.045045.23LP.60	1.11.045045.33LP.60	1.11.045045.43LP.60	1.11.045060.44LP.60	1.11.045090.04LP.60
1.11.045045.23LP.61 (8)	1.11.045045.33LP.61 (8)	1.11.045045.43LP.61 (8)	1.11.045060.44LP.61 (6)	1.11.045090.04LP.61 (4)
$I_x = 14.0$ $I_y = 15.5$ $W_x = 6.2$ $W_y = 6.9$ $G = 2.0$	$I_x = 14.0$ $I_y = 14.7$ $W_x = 6.2$ $W_y = 6.5$ $G = 2.1$	$I_x = 13.5$ $I_y = 13.5$ $W_x = 6.0$ $W_y = 6.0$ $G = 1.9$	$I_x = 26.5$ $I_y = 16.0$ $W_x = 9.0$ $W_y = 7.2$ $G = 2.3$	$I_x = 107.5$ $I_y = 30.4$ $W_x = 23.9$ $W_y = 13.5$ $G = 3.6$

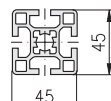
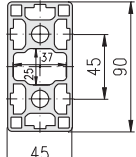
				
				
		Profile 45×45, 4E, SP		Profile 45×90, 0E, SP
		1.11.045045.43SP.60		1.11.045090.04SP.60
		1.11.045045.43SP.61 (8)		1.11.045090.04SP.61 (4)
		$I_x = 15.5$ $I_y = 15.5$ $W_x = 6.9$ $W_y = 6.9$ $G = 2.1$		$I_x = 134.3$ $I_y = 36.3$ $W_x = 29.8$ $W_y = 16.2$ $G = 4.7$

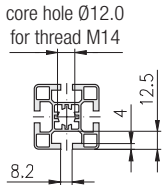
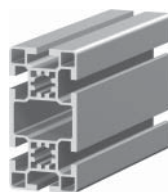
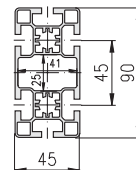
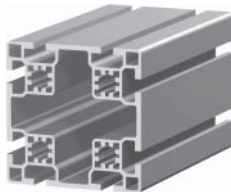
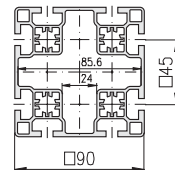
light					
		 	 		
Description	Profile 45×90, 6E, LP	Profile 90×90, 8E, LP			
bar, 6 m	1.11.045090.64LP.60	1.11.090090.83LP.60			
packing unit (number)	1.11.045090.64LP.61 (4)	1.11.090090.83LP.61 (2)			
moment of inertia cm <sup>4</sup>	$I_x = 98.0$ $I_y = 27.5$	$I_x = 190.5$ $I_y = 190.5$			
moment of resistance cm <sup>3</sup>	$W_x = 21.8$ $W_y = 12.2$	$W_x = 42.3$ $W_y = 42.3$			
weight kg/m	$G = 3.3$	$G = 5.6$			

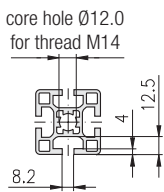
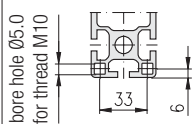
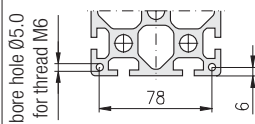
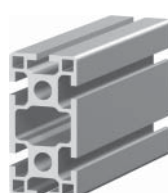
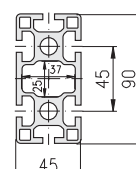
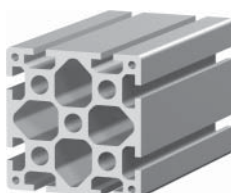
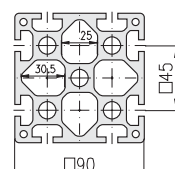

heavy					
  		 	 		
Description	Profile 45×90, 6E, SP	Profile 90×90, 8E, SP			
bar, 6 m	1.11.045090.64SP.60	1.11.090090.83SP.60			
packing unit (number)	1.11.045090.64SP.61 (4)	1.11.090090.83SP.61 (2)			
moment of inertia cm <sup>4</sup>	$I_x = 126.0$ $I_y = 34.0$	$I_x = 282.0$ $I_y = 282.0$			
moment of resistance cm <sup>3</sup>	$W_x = 28.0$ $W_y = 15.0$	$W_x = 63.0$ $W_y = 63.0$			
weight kg/m	$G = 4.4$	$G = 9.5$			





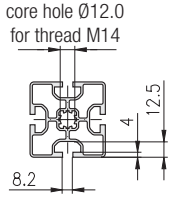
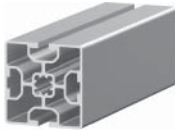
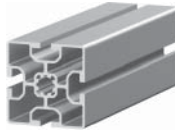
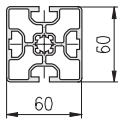
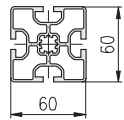

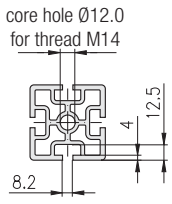
light				

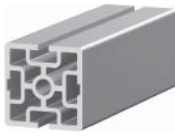
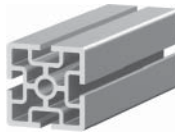
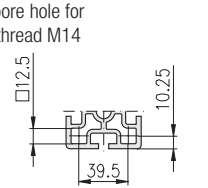
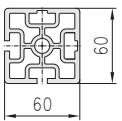
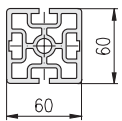
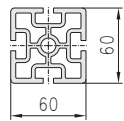

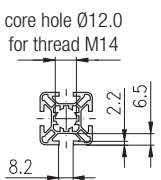

heavy				
Description	Profile 100×200, 12E, SP			
bar, 6 m	1.11.100200.124SP.60			
packing unit (number)	1.11.100200.124SP.61 (2)			
moment of inertia cm <sup>4</sup>	$I_x = 2,450$ $I_y = 760$			
moment of resistance cm <sup>3</sup>	$W_x = 250$ $W_y = 152$			
weight kg/m	$G = 17.2$			

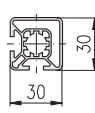
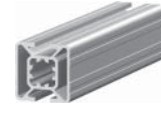
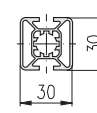

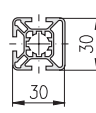
<div style="border: 1px solid black; border-radius: 10px; display: inline-block; padding: 2px 10px; margin-bottom: 10px;">light</div>				
				
				
Description		Profile 60×60, 2E, LP	Profile 60×60, 4E, LP	
bar, 6 m		1.11.060060.23LP.60	1.11.060060.43LP.60	
packing unit (number)		1.11.060060.23LP.61 (6)	1.11.060060.43LP.61 (6)	
moment of inertia cm <sup>4</sup> moment of resistance cm <sup>3</sup> weight kg/m		$I_x = 35.1$ $I_y = 37.7$ $W_x = 11.7$ $W_y = 12.5$ $G = 2.9$	$I_x = 35.5$ $I_y = 35.5$ $W_x = 11.7$ $W_y = 11.7$ $G = 2.7$	

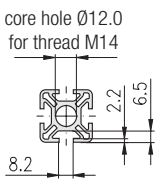

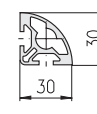
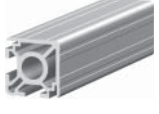
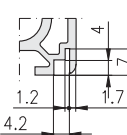
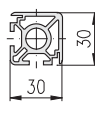

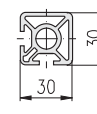
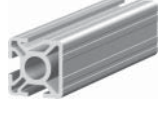
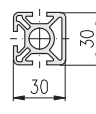
<div style="border: 1px solid black; border-radius: 10px; display: inline-block; padding: 2px 10px; margin-bottom: 10px;">heavy</div>				
				
				
Description	Profile 60×60, 2E, corner, SP	Profile 60×60, 2E, SP	Profile 60×60, 4E, SP	
bar, 6 m	1.11.060060.22SP.60	1.11.060060.23SP.60	1.11.060060.43SP.60	
packing unit (number)	1.11.060060.22SP.61 (6)	1.11.060060.23SP.61 (6)	1.11.060060.43SP.61 (6)	
moment of inertia cm <sup>4</sup> moment of resistance cm <sup>3</sup> weight kg/m	$I_x = 57.2$ $I_y = 57.2$ $W_x = 19.1$ $W_y = 19.1$ $G = 4.3$	$I_x = 55.9$ $I_y = 58.5$ $W_x = 18.6$ $W_y = 19.5$ $G = 4.3$	$I_x = 56.0$ $I_y = 56.0$ $W_x = 18.7$ $W_y = 18.7$ $G = 4.2$	

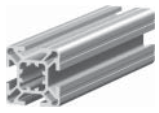
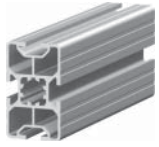
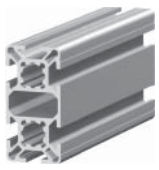
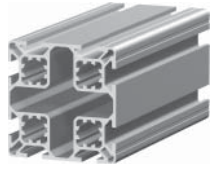

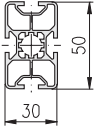
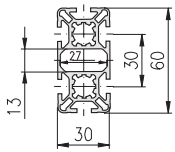
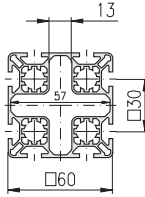
light				
	 	 	 	
Description		Profile 30×30, 2F, corner, L	Profile 30×30, 2F, L	Profile 30×30, 3F, L
bar, 6 m		1.11.030030.22L.60	1.11.030030.23L.60	1.11.030030.33L.60
packing unit (number)		1.11.030030.22L.61 (10)	1.11.030030.23L.61 (10)	1.11.030030.33L.61 (10)
moment of inertia cm <sup>4</sup>		$I_x = 3.2$ $I_y = 3.2$	$I_x = 3.2$ $I_y = 3.2$	$I_x = 3.3$ $I_y = 3.2$
moment of resistance cm <sup>3</sup>		$W_x = 2.1$ $W_y = 2.1$	$W_x = 2.2$ $W_y = 2.2$	$W_x = 2.2$ $W_y = 2.2$
weight kg/m		$G = 0.9$	$G = 0.9$	$G = 0.9$

heavy				
	 	  	 	 
Description	Profile 30×30, 2F, soft, S	Profile 30×30, 2F, corner, S	Profile 30×30, 2F, corner, SB	Profile 30×30, 3F, S
bar, 6 m	1.11.030030.21S.60	1.11.030030.22S.60	1.11.030030.22SB.60	1.11.030030.33S.60
packing unit (number)	1.11.030030.21S.61 (10)	1.11.030030.22S.61 (10)	1.11.030030.22SB.61 (10)	1.11.030030.33S.61 (10)
moment of inertia cm <sup>4</sup>	$I_x = 2.7$ $I_y = 2.7$	$I_x = 3.7$ $I_y = 3.2$	$I_x = 3.7$ $I_y = 3.7$	$I_x = 3.5$ $I_y = 3.7$
moment of resistance cm <sup>3</sup>	$W_x = 1.6$ $W_y = 1.6$	$W_x = 2.4$ $W_y = 2.4$	$W_x = 2.4$ $W_y = 2.4$	$W_x = 2.4$ $W_y = 2.4$
weight kg/m	$G = 0.9$	$G = 1.1$	$G = 1.1$	$G = 1.1$

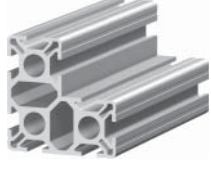
				
				
Profile 30×30, 4F, L	Profile 30×50, 4F, L	Profile 30×60, 6F, L	Profile 60×60, 8F, L	
1.11.030030.43L.60	1.11.030050.44L.60	1.11.030060.64L.60	1.11.060060.83L.60	
1.11.030030.43L.61 (10)	1.11.030050.44L.61 (6)	1.11.030060.64L.61 (6)	1.11.060060.83L.61 (8)	
$I_x = 3.3$ $I_y = 3.3$ $W_x = 2.2$ $W_y = 2.2$ $G = 0.9$	$I_x = 10.5$ $I_y = 4.5$ $W_x = 4.5$ $W_y = 3.5$ $G = 1.3$	$I_x = 21.9$ $I_y = 5.8$ $W_x = 7.4$ $W_y = 3.8$ $G = 1.6$	$I_x = 38.7$ $I_y = 38.7$ $W_x = 12.9$ $W_y = 12.9$ $G = 2.6$	

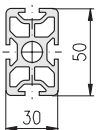
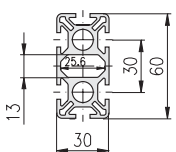
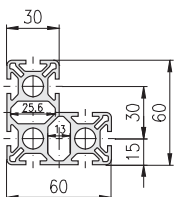
				
				
Profile 30×30, 4F, S	Profile 30×50, 4F, S	Profile 30×60, 6F, S	Profile 60×60, 8F, angle, S	
1.11.030030.43S.60	1.11.030050.44S.60	1.11.030060.65S.60	1.11.060060.87S.60	
1.11.030030.43S.61 (10)	1.11.030050.44S.61 (6)	1.11.030060.65S.61 (6)	1.11.060060.87S.61 (4)	
$I_x = 3.5$ $I_y = 3.5$ $W_x = 2.4$ $W_y = 2.4$ $G = 1.1$	$I_x = 16.1$ $I_y = 6.3$ $W_x = 6.4$ $W_y = 4.2$ $G = 1.9$	$I_x = 25.0$ $I_y = 7.0$ $W_x = 8.3$ $W_y = 4.7$ $G = 2.1$	$I_x = 35.2$ $I_y = 35.2$ $W_x = 9.9$ $W_y = 9.9$ $G = 2.8$	

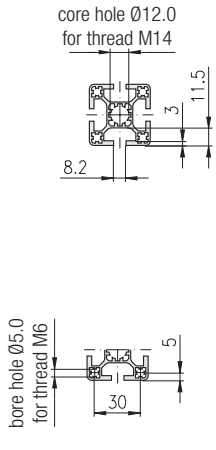
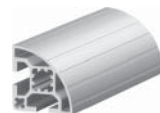
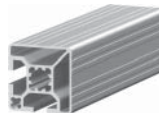
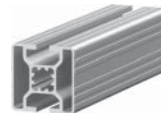
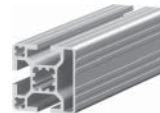
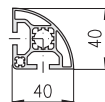
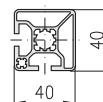
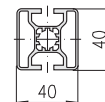
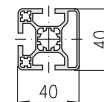
light				
				
				
Description	Profile 40×40, 2E, soft, L	Profile 40×40, 2E, corner, L	Profile 40×40, 2E, L	Profile 40×40, 3E, L
bar, 6 m	1.11.040040.21L.60	1.11.040040.22L.60	1.11.040040.23L.60	1.11.040040.33L.60
packing unit (number)	1.11.040040.21L.61 (8)	1.11.040040.22L.61 (8)	1.11.040040.23L.61 (8)	1.11.040040.33L.61 (8)
moment of inertia cm <sup>4</sup>	$I_x = 6.4$ $I_y = 6.4$	$I_x = 8.0$ $I_y = 8.0$	$I_x = 8.2$ $I_y = 7.5$	$I_x = 8.3$ $I_y = 8.8$
moment of resistance cm <sup>3</sup>	$W_x = 3.8$ $W_y = 3.8$	$W_x = 4.0$ $W_y = 4.0$	$W_x = 4.1$ $W_y = 3.8$	$W_x = 4.1$ $W_y = 4.4$
weight kg/m	$G = 1.2$	$G = 1.3$	$G = 1.3$	$G = 1.4$

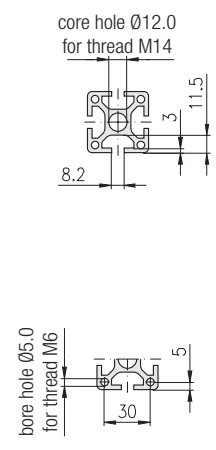
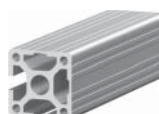
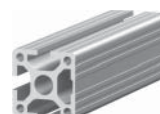
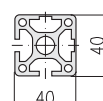
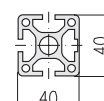
heavy				
				
				
Description		Profile 40×40, 2E, corner, S		Profile 40×40, 3E, S
bar, 6 m		1.11.040040.22S.60		1.11.040040.33S.60
packing unit (number)		1.11.040040.22S.61 (8)		1.11.040040.33S.61 (8)
moment of inertia cm <sup>4</sup>		$I_x = 12.3$ $I_y = 12.3$		$I_x = 12.0$ $I_y = 11.3$
moment of resistance cm <sup>3</sup>		$W_x = 6.1$ $W_y = 6.1$		$W_x = 6.0$ $W_y = 5.6$
weight kg/m		$G = 2.0$		$G = 1.9$

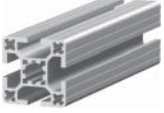
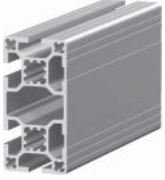
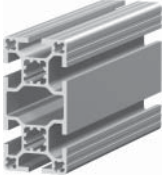
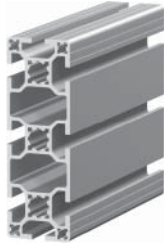
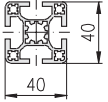
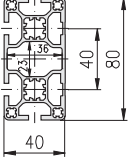
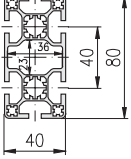
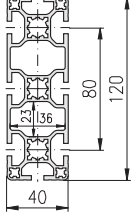
				
				
Profile 40×40, 4E, L	Profile 40×80, 4E, L	Profile 40×80, 6E, L	Profile 40×120, 8E, L	
1.11.040040.43L.60	1.11.040080.44L.60	1.11.040080.64L.60	1.11.040120.84L.60	
1.11.040040.43L.61 (8)	1.11.040080.44L.61 (4)	1.11.040080.64L.61 (4)	1.11.040120.84L.61 (2)	
$I_x = 9.9$ $I_y = 9.9$ $W_x = 4.9$ $W_y = 4.9$ $G = 1.5$	$I_x = 63.2$ $I_y = 17.8$ $W_x = 15.7$ $W_y = 8.9$ $G = 2.6$	$I_x = 62.7$ $I_y = 17.0$ $W_x = 15.6$ $W_y = 8.5$ $G = 2.6$	$I_x = 198.5$ $I_y = 25.2$ $W_x = 34.2$ $W_y = 12.6$ $G = 3.6$	

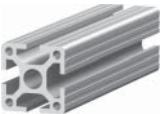
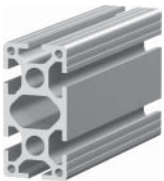
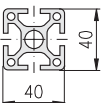
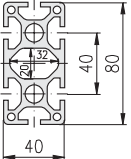
				
				
Profile 40×40, 4E, S		Profile 40×80, 6E, S		
1.11.040040.43S.60		1.11.040080.64S.60		
1.11.040040.43S.61 (8)		1.11.040080.64S.61 (4)		
$I_x = 12.0$ $I_y = 12.0$ $W_x = 6.0$ $W_y = 6.0$ $G = 2.0$		$I_x = 82.0$ $I_y = 23.4$ $W_x = 20.5$ $W_y = 11.7$ $G = 3.8$		



light				
Description	Profile 80×80, 8E, L	Profile 80×80, 8E, LB	Profile 80×160, 12E, L	
bar, 6 m	1.11.080080.83L.60	1.11.080080.83LB.60	1.11.080160.124L.60	
packing unit (number)	1.11.080080.83L.61 (2)	1.11.080080.83LB.61 (2)	1.11.080160.124L.61 (2)	
moment of inertia cm <sup>4</sup>	$I_x = 111.0$ $I_y = 111.0$	$I_x = 110.2$ $I_y = 110.2$	$I_x = 794.0$ $I_y = 233.0$	
moment of resistance cm <sup>3</sup>	$W_x = 28.0$ $W_y = 28.0$	$W_x = 27.6$ $W_y = 27.6$	$W_x = 99.3$ $W_y = 58.3$	
weight kg/m	$G = 4.1$	$G = 4.5$	$G = 8.8$	

heavy				
Description	Profile 80×80, 8E, S	Profile 80×80, 8E, angle, S	Profile 80×160, 12E, S	
bar, 6 m	1.11.080080.83S.60	1.11.080080.87S.60	1.11.080160.124S.60	
packing unit (number)	1.11.080080.83S.61 (2)	1.11.080080.87S.61 (2)	1.11.080160.124S.61 (2)	
moment of inertia cm <sup>4</sup>	$I_x = 166.0$ $I_y = 166.0$	$I_x = 120.0$ $I_y = 120.0$	$I_x = 880.0$ $I_y = 268.0$	
moment of resistance cm <sup>3</sup>	$W_x = 41.4$ $W_y = 41.4$	$W_x = 23.8$ $W_y = 23.8$	$W_x = 110.0$ $W_y = 67.0$	
weight kg/m	$G = 5.9$	$G = 5.4$	$G = 9.4$	

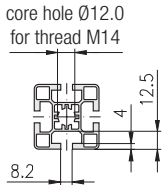
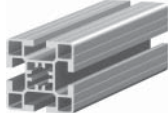
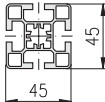
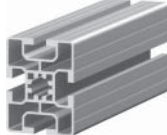
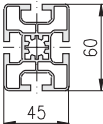
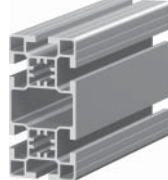
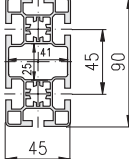
light				
	 	 	 	
Description	Profile 45×45, 4E, L	Profile 45×60, 4E, L	Profile 45×90, 6E, L	
bar, 6 m	1.11.045045.43L.60	1.11.045060.44L.60	1.11.045090.64L.60	
packing unit (number)	1.11.045045.43L.61 (8)	1.11.045060.44L.61 (6)	1.11.045090.64L.61 (4)	
moment of inertia cm <sup>4</sup>	$I_x = 13.5$ $I_y = 13.5$	$I_x = 26.5$ $I_y = 16.0$	$I_x = 98.0$ $I_y = 27.5$	
moment of resistance cm <sup>3</sup>	$W_x = 6.0$ $W_y = 6.0$	$W_x = 9.0$ $W_y = 7.2$	$W_x = 21.8$ $W_y = 12.2$	
weight kg/m	$G = 1.9$	$G = 2.3$	$G = 3.3$	

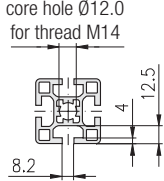
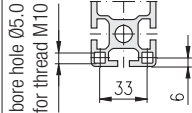
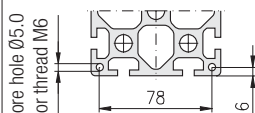
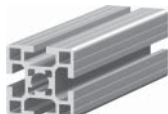
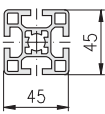
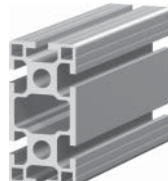
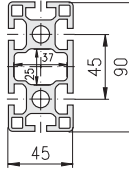
heavy				
  	 		 	
Description	Profile 45×45, 4E, S		Profile 45×90, 6E, S	
bar, 6 m	1.11.045045.43S.60		1.11.045090.64S.60	
packing unit (number)	1.11.045045.43S.61 (8)		1.11.045090.64S.61 (4)	
moment of inertia cm <sup>4</sup>	$I_x = 16.8$ $I_y = 16.8$		$I_x = 126.0$ $I_y = 34.0$	
moment of resistance cm <sup>3</sup>	$W_x = 7.4$ $W_y = 7.4$		$W_x = 28.0$ $W_y = 15.0$	
weight kg/m	$G = 2.3$		$G = 4.4$	

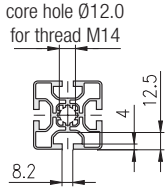
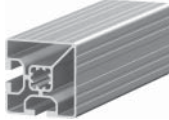
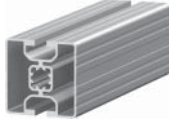
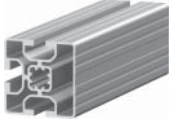
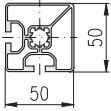
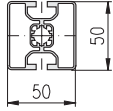
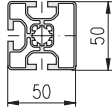
<div style="border: 1px solid black; border-radius: 10px; padding: 2px 10px; display: inline-block; margin-bottom: 10px;">light</div>				
				
				
				
Description		Profile 50×50, 2E, corner, L	Profile 50×50, 2E, L	Profile 50×50, 3E, L
bar, 6 m		1.11.050050.22L.60	1.11.050050.23L.60	1.11.050050.33L.60
packing unit (number)		1.11.050050.22L.61 (6)	1.11.050050.23L.61 (6)	1.11.050050.33L.61 (6)
moment of inertia cm <sup>4</sup>		$I_x = 16.5$ $I_y = 16.5$	$I_x = 17.7$ $I_y = 13.6$	$I_x = 18.4$ $I_y = 16.0$
moment of resistance cm <sup>3</sup>		$W_x = 6.7$ $W_y = 6.7$	$W_x = 7.0$ $W_y = 5.4$	$W_x = 7.3$ $W_y = 5.8$
weight kg/m		G = 1.7	G = 1.6	G = 1.9

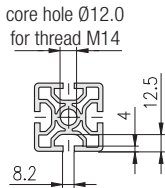
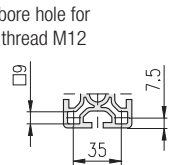
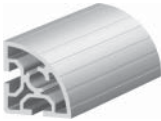
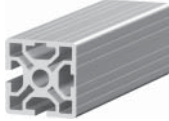
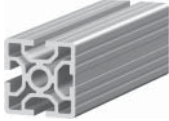
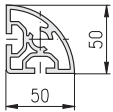
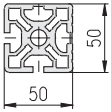
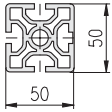
<div style="border: 1px solid black; border-radius: 10px; padding: 2px 10px; display: inline-block; margin-bottom: 10px;">heavy</div>				
  				
				
				
Description	Profile 50×50, 2E, soft, S	Profile 50×50, 2E, corner, S		Profile 50×50, 3E, S
bar, 6 m	1.11.050050.21S.60	1.11.050050.22S.60		1.11.050050.33S.60
packing unit (number)	1.11.050050.21S.61 (6)	1.11.050050.22S.61 (6)		1.11.050050.33S.61 (6)
moment of inertia cm <sup>4</sup>	$I_x = 18.8$ $I_y = 18.8$	$I_x = 27.4$ $I_y = 27.4$		$I_x = 27.3$ $I_y = 28.2$
moment of resistance cm <sup>3</sup>	$W_x = 7.5$ $W_y = 7.5$	$W_x = 10.9$ $W_y = 10.9$		$W_x = 11.1$ $W_y = 11.1$
weight kg/m	G = 2.3	G = 3.0		G = 3.1

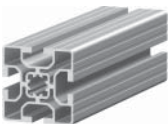
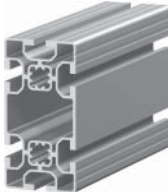
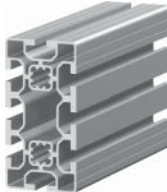
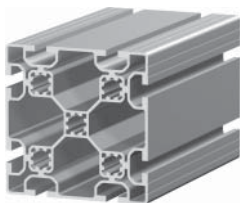
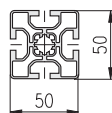
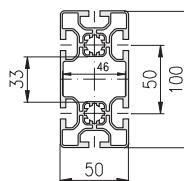
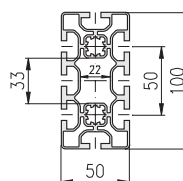
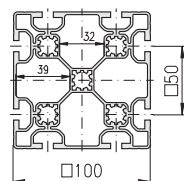
				
				
Profile 50×50, 4E, L	Profile 50×100, 6E, L	Profile 50×100, 8E, L		Profile 100×100, 8E, L
1.11.050050.43L.60	1.11.050100.64L.60	1.11.050100.84L.60		1.11.100100.83L.60
1.11.050050.43L.61 (6)	1.11.050100.64L.61 (3)	1.11.050100.84L.61 (3)		1.11.100100.83L.61 (2)
$I_x = 19.2$ $I_y = 19.2$ $W_x = 7.7$ $W_y = 7.7$ $G = 2.2$	$I_x = 138.0$ $I_y = 37.0$ $W_x = 27.5$ $W_y = 14.5$ $G = 3.5$	$I_x = 137.0$ $I_y = 40.0$ $W_x = 27.5$ $W_y = 16.0$ $G = 4.0$		$I_x = 254.1$ $I_y = 254.1$ $W_x = 45.4$ $W_y = 45.4$ $G = 6.2$

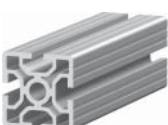
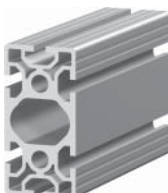
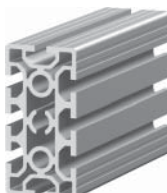
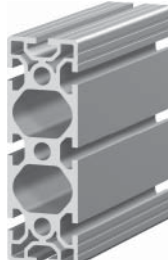
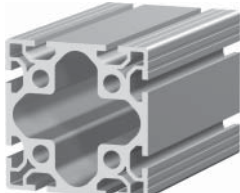
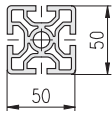
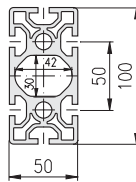
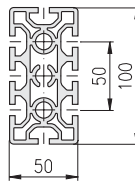
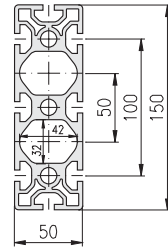
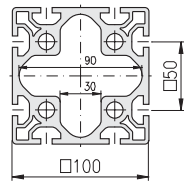
				
				
Profile 50×50, 4E, S	Profile 50×100, 6E, S	Profile 50×100, 8E, S	Profile 50×150, 8E, S	Profile 100×100, 8E, S
1.11.050050.43S.60	1.11.050100.65S.60	1.11.050100.84S.60	1.11.050150.85S.60	1.11.100100.83S.60
1.11.050050.43S.61 (6)	1.11.050100.65S.61 (3)	1.11.050100.84S.61 (3)	1.11.050150.85S.61 (2)	1.11.100100.83S.61 (2)
$I_x = 27.3$ $I_y = 27.3$ $W_x = 11.0$ $W_y = 11.0$ $G = 3.1$	$I_x = 202.0$ $I_y = 57.2$ $W_x = 40.4$ $W_y = 22.8$ $G = 5.9$	$I_x = 200.0$ $I_y = 53.3$ $W_x = 39.9$ $W_y = 21.3$ $G = 6.0$	$I_x = 628.0$ $I_y = 83.0$ $W_x = 83.0$ $W_y = 33.0$ $G = 8.1$	$I_x = 411.0$ $I_y = 411.0$ $W_x = 82.0$ $W_y = 82.0$ $G = 9.7$

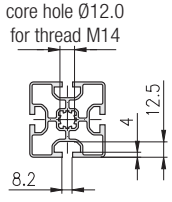
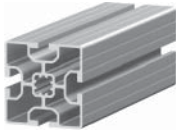
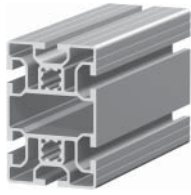
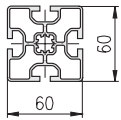
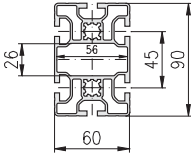

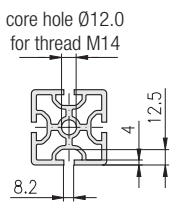
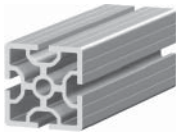
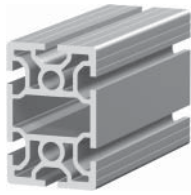
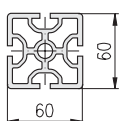
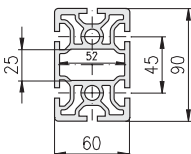
light				
				
				
Description	Profile 60×60, 4E, L	Profile 60×90, 6E, L		
bar, 6 m	1.11.060060.43L.60	1.11.060090.64L.60		
packing unit (number)	1.11.060060.43L.61 (6)	1.11.060090.64L.61 (3)		
moment of inertia cm <sup>4</sup>	$I_x = 35.5$ $I_y = 35.5$	$I_x = 125.8$ $I_y = 54.3$		
moment of resistance cm <sup>3</sup>	$W_x = 11.7$ $W_y = 11.7$	$W_x = 27.9$ $W_y = 18.1$		
weight kg/m	$G = 2.7$	$G = 3.9$		

heavy				
				
				
Description	Profile 60×60, 4E, S	Profile 60×90, 6E, S		
bar, 6 m	1.11.060060.43S.60	1.11.060090.64S.60		
packing unit (number)	1.11.060060.43S.61 (6)	1.11.060090.64S.61 (3)		
moment of inertia cm <sup>4</sup>	$I_x = 56.0$ $I_y = 56.0$	$I_x = 193.0$ $I_y = 83.0$		
moment of resistance cm <sup>3</sup>	$W_x = 18.7$ $W_y = 18.7$	$W_x = 43.0$ $W_y = 27.5$		
weight kg/m	$G = 4.2$	$G = 6.0$		

heavy				
Description	Profile 48, round, 1E, SP	Profile 48, round, 2E, corner, SP	Profile 48, round, 2E, SP	
bar, 6 m	1.11.048R00.10SP.60	1.11.048R00.22SP.60	1.11.048R00.20SP.60	
packing unit (number)	1.11.048R00.10SP.61 (6)	1.11.048R00.22SP.61 (6)	1.11.048R00.20SP.61 (6)	
moment of inertia cm <sup>4</sup>	$I_x = 12.5$ $I_y = 12.9$	$I_x = 12.0$ $I_y = 12.0$	$I_x = 12.5$ $I_y = 13.5$	
moment of resistance cm <sup>3</sup>	$W_x = 4.9$ $W_y = 5.4$	$W_x = 5.0$ $W_y = 5.0$	$W_x = 5.1$ $W_y = 5.9$	
weight kg/m	G = 1.8	G = 2.0	G = 2.0	

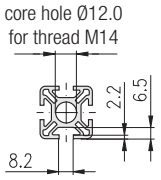

## Profiles octagonal, F / E3-slot, P (plain)

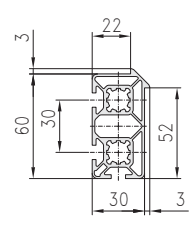
heavy				
Description	Profile 30, octagonal, 8F, SP	Profile 40, octagonal, 8E, SP		
bar, 6 m	1.11.0308kt.89SP.60	1.11.0408kt.89SP.60		
packing unit (number)	1.11.0308kt.89SP.61 (2)	1.11.0408kt.89SP.61 (2)		
moment of inertia cm <sup>4</sup>	$I_x = 84.0$ $I_y = 84.0$	$I_x = 176.6$ $I_y = 176.6$		
moment of resistance cm <sup>3</sup>	$W_x = 21.0$ $W_y = 21.0$	$W_x = 35.3$ $W_y = 35.3$		
weight kg/m	G = 3.9	G = 5.8		

light				
				
				
Description		Panel bazel profile 30×60, 3F, 45°, LP		
bar, 6 m		1.13.030060.39LP.60		
packing unit (number)		1.13.030060.39LP.61 (4)		
moment of inertia cm <sup>4</sup>		$I_x = 22.8$ $I_y = 6.1$		
moment of resistance cm <sup>3</sup>		$W_x = 7.6$ $W_y = 4.0$		
weight kg/m		$G = 1.7$		

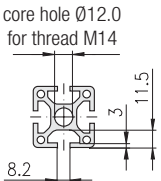
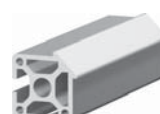
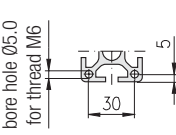
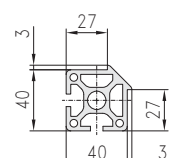
## Panel bazel profile 40, E3-slot, P (plain)

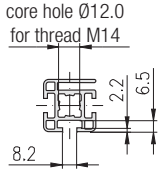
heavy				
				
				
Description		Panel bazel profile 40×40, 2E, 45°, SP		
bar, 6 m		1.13.040040.29SP.60		
packing unit (number)		1.13.040040.29SP.61 (8)		
moment of inertia cm <sup>4</sup>		$I_x = 12.1$ $I_y = 12.1$		
moment of resistance cm <sup>3</sup>		$W_x = 6.1$ $W_y = 6.1$		
weight kg/m		$G = 2.1$		

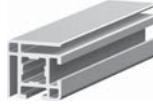
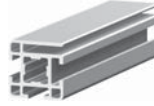
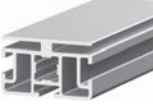
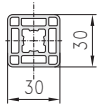
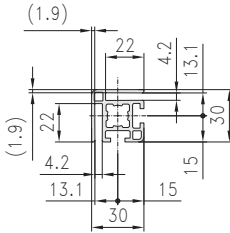
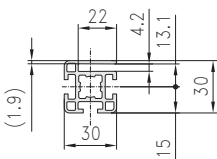
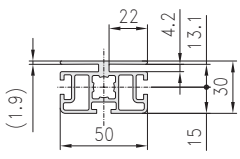
light				
				
				
Description	Panel profile 30×30, OF, LP	Panel profile 30×30, 2F, corner, LP 4	Panel profile 30×30, 3F, LP 4	Panel profile 30×50, 3F, LP 4
bar, 6 m	1.14.030030.03LP0.60	1.14.030030.22LP4.60	1.14.030030.33LP4.60	1.14.030050.34LP4.60
packing unit (number)	1.14.030030.03LP0.61(10)	1.14.030030.22LP4.61(10)	1.14.030030.33LP4.61(10)	1.14.030050.34LP4.61 (6)
moment of inertia cm <sup>4</sup>	$I_x = 3.8$ $I_y = 3.8$	$I_x = 3.3$ $I_y = 3.3$	$I_x = 3.3$ $I_y = 2.8$	$I_x = 5.5$ $I_y = 11.8$
moment of resistance cm <sup>3</sup>	$W_x = 2.4$ $W_y = 2.4$	$W_x = 2.2$ $W_y = 2.2$	$W_x = 2.2$ $W_y = 1.8$	$W_x = 3.6$ $W_y = 4.8$
weight kg/m	$G = 1.1$	$G = 1.0$	$G = 0.9$	$G = 1.5$

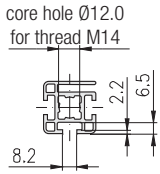
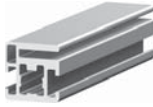
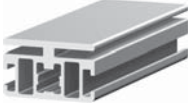
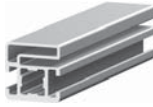
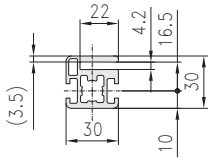
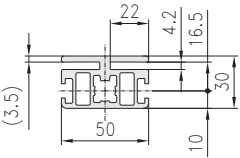
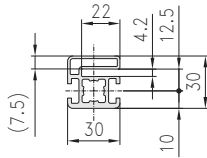
light				
				
				
Description	Panel profile 30×30, 2F, LP 5	Panel profile 30×50, 2F, LP 5	Panel profile 30×30, 2F, LP 6	
bar, 6 m	1.14.030030.23LP5.60	1.14.030050.24LP5.60	1.14.030030.23LP6.60	
packing unit (number)	1.14.030030.23LP5.61(10)	1.14.030050.24LP5.61(10)	1.14.030030.23LP6.61 (6)	
moment of inertia cm <sup>4</sup>	$I_x = 4.3$ $I_y = 3.3$	$I_x = 7.0$ $I_y = 14.7$	$I_x = 3.6$ $I_y = 2.8$	
moment of resistance cm <sup>3</sup>	$W_x = 2.8$ $W_y = 2.2$	$W_x = 4.7$ $W_y = 5.9$	$W_x = 2.4$ $W_y = 1.9$	
weight kg/m	$G = 1.2$	$G = 1.9$	$G = 1.0$	



<p>light</p>					
	Description	Panel profile 40×40, 2E, corner, LP 4	Panel profile 40×40, 3E, LP 4	Panel profile 40×60, 3E, LP 4	Panel profile 60×80, 5E, LP 4
	bar, 6 m	1.14.040040.22LP4.60	1.14.040040.33LP4.60	1.14.040060.34LP4.60	1.14.060080.54LP4.60
	packing unit (number)	1.14.040040.22LP4.61 (8)	1.14.040040.33LP4.61 (8)	1.14.040060.34LP4.61 (8)	1.14.060080.54LP4.61 (4)
	moment of inertia cm <sup>4</sup> moment of resistance cm <sup>3</sup> weight kg/m	$I_x = 10.3$ $I_y = 10.3$ $W_x = 5.2$ $W_y = 5.2$ G = 1.8	$I_x = 10.2$ $I_y = 8.7$ $W_x = 5.1$ $W_y = 4.3$ G = 1.65	$I_x = 14.8$ $I_y = 26.3$ $W_x = 7.4$ $W_y = 8.8$ G = 2.4	$I_x = 100.4$ $I_y = 50.4$ $W_x = 25.1$ $W_y = 16.8$ G = 3.8

<p>light</p>	<b>Profile for door stop</b>				
			<p>Assembly drawing</p>	<p>Assembly drawing</p>	
	Description	Panel profile 60×80, 6E, LP 4	Profile 20×30, 1F, LP		
	bar, 6 m	1.14.060080.64LP4.60	1.11.020030.14LP.60		
	packing unit (number)	1.14.060080.64LP4.61 (4)	1.11.020030.14LP.61 (10)		
moment of inertia cm <sup>4</sup> moment of resistance cm <sup>3</sup> weight kg/m	$I_x = 88.1$ $I_y = 52.0$ $W_x = 22.1$ $W_y = 17.3$ G = 3.7	$I_x = 2.2$ $I_y = 1.4$ $W_x = 1.5$ $W_y = 1.4$ G = 0.7	$I_x = 113.0$ $I_y = 64.0$ $W_x = 28.5$ $W_y = 21.3$ G = 4.5	$I_x = 89.2$ $I_y = 53.3$ $W_x = 22.3$ $W_y = 17.7$ G = 4.4	

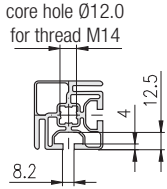
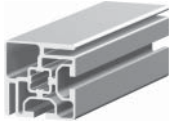
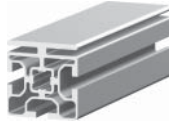
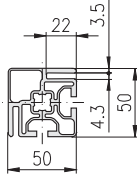
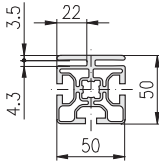
light				
 <p>core hole Ø12.0 for thread M14</p>				
				
Description	Panel profile 50×50, 2E, corner, LP 4	Panel profile 50×50, 3E, LP 4		
bar, 6 m	1.14.050050.22LP4.60	1.14.050050.39LP4.60		
packing unit (number)	1.14.050050.22LP4.61 (6)	1.14.050050.39LP4.61 (6)		
moment of inertia cm <sup>4</sup>	$I_x = 19.4$ $I_y = 19.4$	$I_x = 24.1$ $I_y = 21.4$		
moment of resistance cm <sup>3</sup>	$W_x = 7.6$ $W_y = 7.6$	$W_x = 8.0$ $W_y = 8.5$		
weight kg/m	$G = 2.4$	$G = 2.7$		



light				

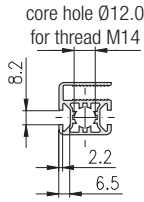
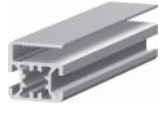
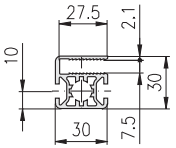
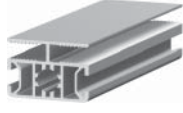
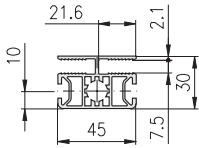

light				
	 	 		
Description	Wire net profile 30×30, 2F, LP 7.5	Wire net profile 30×45, 2F, LP 7.5		
bar, 6 m	1.15.030030.23LP7.60	1.15.030045.24LP7.60		
packing unit (number)	1.15.030030.23LP7.61(10)	1.15.030045.24LP7.61 (8)		
moment of inertia cm <sup>4</sup>	$I_x = 2.6$ $I_y = 3.2$	$I_x = 4.3$ $I_y = 7.4$		
moment of resistance cm <sup>3</sup>	$W_x = 1.7$ $W_y = 2.1$	$W_x = 2.9$ $W_y = 3.3$		
weight kg/m	$G = 0.86$	$G = 1.15$		

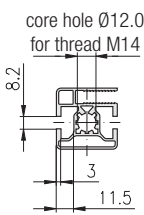
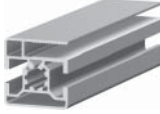
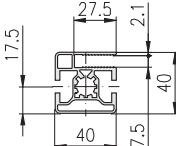
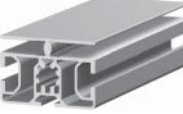
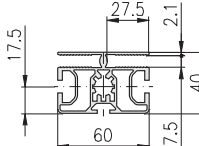

**Wire net profiles 40, F / E3-slot, P (plain)**

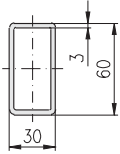
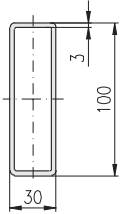
light				
	 	 		
Description	Wire net profile 40×40, 2E, LP 7.5	Wire net profile 40×60, 2E, 1F, LP 7.5		
bar, 6 m	1.15.040040.23LP7.60	1.15.040060.34LP7.60		
packing unit (number)	1.15.040040.23LP7.61 (8)	1.15.040060.34LP7.61 (8)		
moment of inertia cm <sup>4</sup>	$I_x = 7.5$ $I_y = 8.2$	$I_x = 12.2$ $I_y = 22.5$		
moment of resistance cm <sup>3</sup>	$W_x = 3.8$ $W_y = 4.1$	$W_x = 6.1$ $W_y = 7.5$		
weight kg/m	$G = 1.35$	$G = 1.97$		







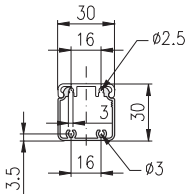

light	 			
<b>Technical data</b> material: Al Mg Si 0.5 F25 tensile strength: 250 N/mm <sup>2</sup> surface: natural anodised				
Description	Tube profile 30×60, LP	Tube profile 30×100, LP		
bar, 6 m	1.17.030060.04LP.60	1.17.030100.04LP.60		
packing unit (number)	1.17.030060.04LP.61 (6)	1.17.030100.04LP.61 (4)		
moment of inertia cm <sup>4</sup>	$I_x = 24.0$ $I_y = 7.5$	$I_x = 90.0$ $I_y = 12.0$		
moment of resistance cm <sup>3</sup>	$W_x = 8.0$ $W_y = 5.0$	$W_x = 18.0$ $W_y = 8.0$		
weight kg/m	G = 1.47	G = 2.20		

light				

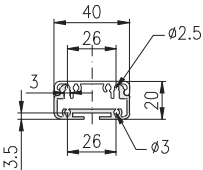

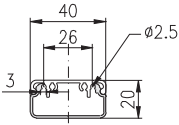

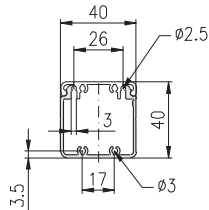
<b>Cover profile 30</b>			Description	E-trunking profile, lid 30
			bar, 6 m	1.19.2030D.60
			packing unit (number)	1.19.2030D.61 (8)
			cut to length	1.19.2030D-A00A00/...
			weight kg/m	G = 0.24
<b>Base profiles 30</b>	 			
			<b>Technical data</b>	
			material: Al Mg Si 0.5 F25	
			tensile strength: 250 N/mm <sup>2</sup>	
			surface: natural anodised	
Description	E-trunking profile 30×30			
bar, 6 m	1.19.203030G.60			
packing unit (number)	1.19.203030G.61 (8)			
cut to length	1.19.203030G-A00A00/...			
weight kg/m	G = 0.38			

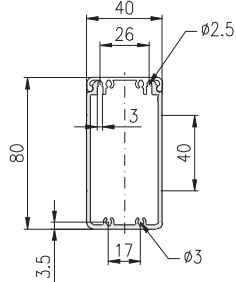
End plates  318



<b>Cover profile 40</b>					Description	E-trunking profile, lid 40				
					bar, 6 m	1.19.2040D.60				
					packing unit (number)	1.19.2040D.61 (8)				
					cut to length	1.19.2040D-A00A00/...				
					weight kg/m	G = 0.35				
<b>Base profiles 40</b>	 		 		 		 			
									<b>Technical data</b>	
									material: Al Mg Si 0.5 F25	
									tensile strength: 250 N/mm <sup>2</sup>	
									surface: natural anodised	
Description	E-trunking profile 40×20, for clips	E-trunking profile 40×20	E-trunking profile 40×40	E-trunking profile 40×80						
bar, 6 m	1.19.214020G.60	1.19.204020G.60	1.19.204040G.60	1.19.204080G.60						
packing unit (number)	1.19.214020G.61 (16)	1.19.204020G.61 (16)	1.19.204040G.61 (8)	1.19.204080G.61 (4)						
cut to length	1.19.214020G-A00A00/...	1.19.204020G-A00A00/...	1.19.204040G-A00A00/...	1.19.204080G-F00F00/...						
weight kg/m	G = 0.50	G = 0.30	G = 0.61	G = 1.24						

End plates  318

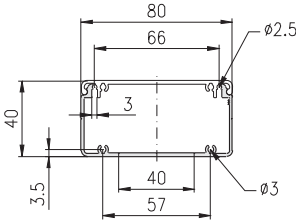
(/... = Length in mm)

<b>Cover profile 80</b>		Description	E-trunking profile, lid 80
		bar, 6 m	1.19.2080D.60
<b>Base profiles 80</b>	 	packing unit (number)	1.19.2080D.61 (4)
		cut to length	1.19.2080D-F00F00/...
		weight kg/m	G = 0.59
<b>Technical data</b>			
material:	Al Mg Si 0.5 F25		
tensile strength:	250 N/mm <sup>2</sup>		
surface:	natural anodised		
Description	E-trunking profile 80×40	E-trunking profile 80×80	
bar, 6 m	1.19.208040G.60	1.19.208080G.60	
packing unit (number)	1.19.208040G.61 (4)	1.19.208080G.61 (2)	
cut to length	1.19.208040G-F00F00/...	1.19.208080G-F00F00/...	
weight kg/m	G = 1.20	G = 1.55	

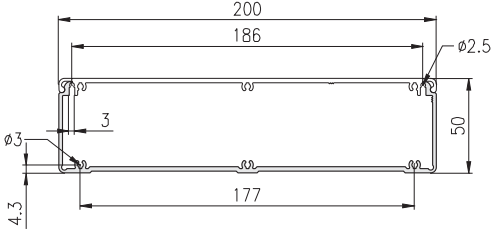

End plates ↗ 318

<b>Cover profile 200</b>		Description	E-trunking profile, lid 200
		bar, 6 m	1.19.2200D.60
<b>Base profile 200</b>	 	packing unit (number)	1.19.2200D.61 (2)
		cut to length	1.19.2200D-L00L00/...
		weight kg/m	G = 1.50
<b>Technical data</b>			
material:	Al Mg Si 0.5 F25		
tensile strength:	250 N/mm <sup>2</sup>		
surface:	natural anodised		
Description	E-trunking profile 200×50		
bar, 6 m	1.19.220050G.60		
packing unit (number)	1.19.220050G.61 (2)		
cut to length	1.19.220050G-L00L00/...		
weight kg/m	G = 2.00		

End plates ↗ 318

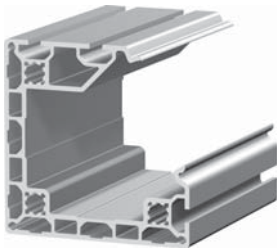
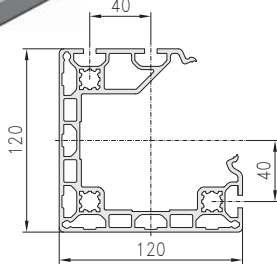
(/... = Length in mm)

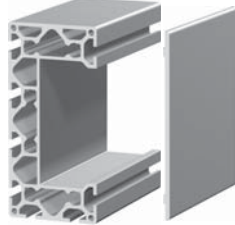
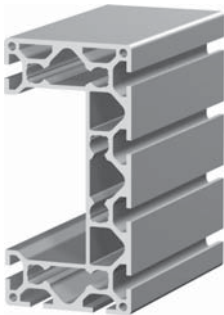
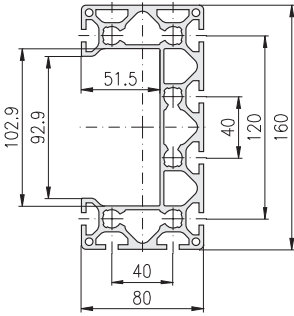

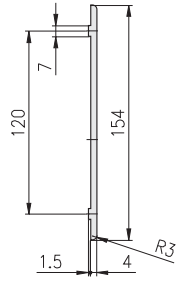
<b>Cover profile 80</b>  	  	Description	E-trunking profile, lid 80
		bar, 6 m	1.19.2080D.60
		packing unit (number)	1.19.2080D.61 (4)
		cut to length	1.19.2080D-F00F00/...
		weight kg/m	G = 0.59
<b>Base profile 120</b>  <b>Technical data</b> material: Al Mg Si 0.5 F25 tensile strength: 250 N/mm <sup>2</sup> surface: natural anodised			
Description		E-trunking profile 120×120, 3E, LP	
bar, 6 m		1.11.120120.39LP.60	
packing unit (number)			
moment of inertia cm <sup>4</sup>		$I_x = 538.3$ $I_y = 275.2$	
moment of resistance cm <sup>3</sup>		$W_x = 89.8$ $W_y = 45.8$	
weight kg/m		G = 6.7	

<b>E-trunking profile 160</b>  	Base profile: Profile 80×160, 8E, SP ↗ 27, 316-319		Cover profile: Profile pre-cut lid 120 ↗ 56, 316-319		
	  	  			
<b>Technical data</b> material: Al Mg Si 0.5 F25 tensile strength: 250 N/mm <sup>2</sup> surface: natural anodised					
Description		Profile 80×160, 8E, SP		Profile pre-cut lid 120	
bar, 6 m		1.11.080160.89SP.60		1.19.1101120.60	
packing unit (number)		1.11.080160.89SP.61 (2)		1.19.1101120-L00L00/... (cut to length)	
moment of inertia cm <sup>4</sup>		$I_x = 944.0$ $I_y = 183.0$			
moment of resistance cm <sup>3</sup>		$W_x = 118.0$ $W_y = 45.8$			
weight kg/m		G = 7.9		G = 1.80	

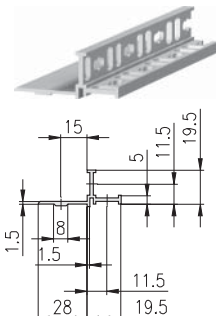
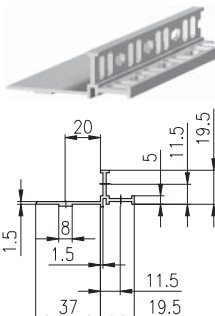
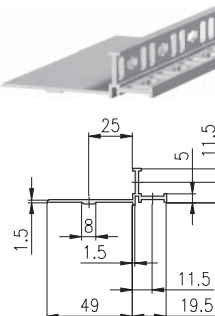



(/... = Length in mm); machining data ↗ Profile machining 1.1A

<b>19" profiles</b>  <b>Technical data</b> material: Al Mg Si 0.5 F25 tensile strength: 250 N/mm <sup>2</sup> surface: natural anodised					
	Description	19" profile, PG 30	19" profile, PG 40	19" profile, PG 50	
	bar, 6 m	1.19.19030.60	1.19.19040.60	1.19.19050.60	
	cut to length	1.19.19030-A00A00/...	1.19.19040-A00A00/...	1.19.19050-A00A00/...	
	weight                      kg/m	G = 0.4	G = 0.45	G = 0.5	



**Tubes**

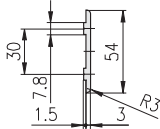
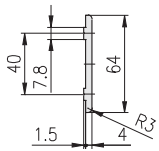
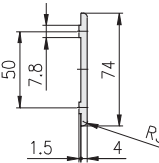
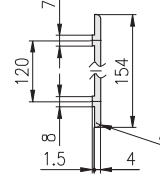

<b>Tubes</b>  <b>Technical data</b> material: Al Mg Si 0.5 F22 extruded profiles as per DIN 755-9 tensile strength: 250 N/mm <sup>2</sup> surface: natural anodised					
	Description	Tube Ø20×2	Tube Ø30×3	Tube Ø40×4	
	bar, 6 m	1.19.16120.60	1.19.16130.60	1.19.16140.60	
	cut to length	1.19.16120-A00A00/...	1.19.16130-A00A00/...	1.19.16140-A00A00/...	
	weight                      kg/m	G = 0.3	G = 0.7	G = 1.3	



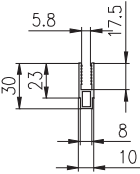
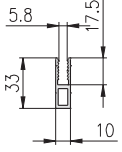

Profile pre-cut lids					
<b>Technical data</b> material: Al Mg Si 0.5 F25 tensile strength: 250 N/mm <sup>2</sup> surface: natural anodised					
Description		Profile pre-cut lid 30	Profile pre-cut lid 40	Profile pre-cut lid 50	Profile pre-cut lid 120
bar, 6 m		1.19.110130.60	1.19.110140.60	1.19.110150.60	1.19.110120.60
cut to length		1.19.110130-A00A00/...	1.19.110140-A00A00/...	1.19.110150-F00F00/...	1.19.110120-L00L00/...
weight	kg/m	G = 0.49	G = 0.74	G = 0.85	G = 1.80

Application  
 E-trunking profiles, 52, 316-319

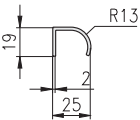
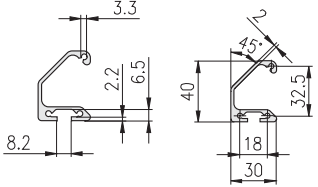
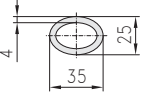
Wire net mounting profiles					
<b>Technical data</b> material: Al Mg Si 0.5 F25 tensile strength: 250 N/mm <sup>2</sup> surface: natural anodised					
Description		Wire net mounting profile	Wire net mounting profile 33×10		
bar, 6 m		1.19.14230.60	1.19.1423310.60		
cut to length		1.19.14230-A00A00/...	1.19.1423310-A00A00/...		
weight	kg/m	G = 0.3	G = 0.4		

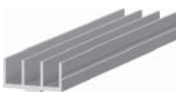
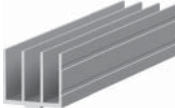
Grab handle profiles		F-slot		Oval tube
<b>Technical data</b> material: Al Mg Si 0.5 F25 tensile strength: 250 N/mm <sup>2</sup> surface: natural anodised				
				
Description		Grab handle profile	Grab handle profile	Oval tube 35×4
bar, 6 m		1.19.14319.60	1.19.14330.60	1.19.14535.30
cut to length		1.19.14319-A00A00/...	1.19.14330-A00A00/...	1.19.14535-A00A00/...
weight	kg/m	G = 0.3	G = 0.73	G = 0.83

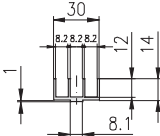
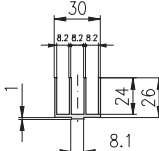
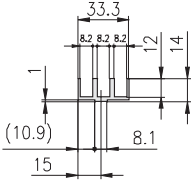
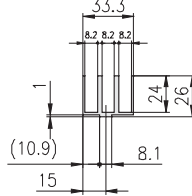
Sliding profiles					
<b>Technical data</b> material: Al Mg Si 0.5 F25 tensile strength: 250 N/mm <sup>2</sup> surface: natural anodised					
Description	Sliding profile 30×14	Sliding profile 30×26	Sliding profile 33×14	Sliding profile 33×26	
bar, 6 m	1.19.15130.60	1.19.15131.60	1.19.15133.60	1.19.15134.60	
cut to length	1.19.15130-A00A00/...	1.19.15131-A00A00/...	1.19.15133-A00A00/...	1.19.15134-A00A00/...	
weight	kg/m	G = 0.4	G = 0.6	G = 0.5	G = 0.8

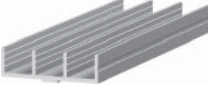
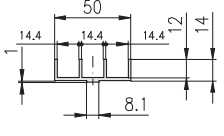
Sliding profile					
<b>Technical data</b> material: Al Mg Si 0.5 F25 tensile strength: 250 N/mm <sup>2</sup> surface: natural anodised					
Description	Sliding profile 50×14				
bar, 6 m	1.19.15150.60				
cut to length	1.19.15150-A00A00/...				
weight	kg/m	G = 0.6			

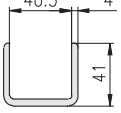
U-profile		
<b>Technical data</b> material: Al Mg Si 0.5 F25 tensile strength: 250 N/mm <sup>2</sup> surface: natural anodised		
Description	U-profile 40	
bar, 6 m	1.19.14440.60	
cut to length	1.19.14440-A00A00/...	
weight	kg/m	G = 1.35

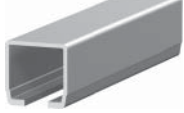
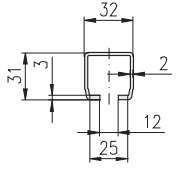
C-track		
<b>Technical data</b> material: Al Mg Si 0.5 F25 tensile strength: 250 N/mm <sup>2</sup> surface: natural anodised		
Description	C-track	
bar, 6 m	1.19.14532.60	
cut to length	1.19.14532-A00A00/...	
weight	kg/m	G = 0.6

### Summary

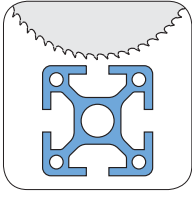

Saw cut

↔ 59

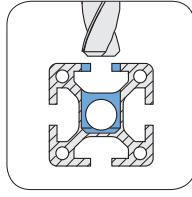

Cross bushing bores for connectors

↔ 60

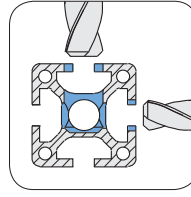

Bores for parallel-connector

↔ 60

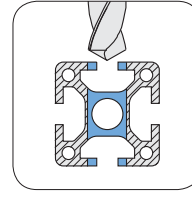

Cross bore

↔ 60

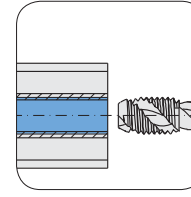

Thread

↔ 60

**Comments**

- Profile machinings are defined by the article-number of the profile.
- For more complex machinings, additional order descriptions are needed.
- Non-standard machinings will be completed as per drawings

### Order description

Profile	machining	profile side	
	left right		
Order-No.: 1.□□.□□□□□□.□□□□ -	□□□□□□ / □□□□		
	□□□□□□ / □□□□	saw cut	↔ 59
	□□□□□□ / □□□□	cross bushing bores, bores for parallel-connector, cross bore, thread	↔ 60
	□□□□□□ / □□□□	direction	↔ 61
	□□□□□□ / □□□□	length in mm	

Order example

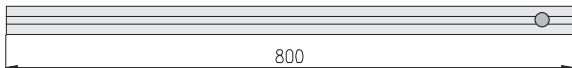

<b>Description</b> Profile 40×40, 4E-slots, S Length: 800 mm right side: 1 connector bore	<b>Article-No.</b> 1.11.040040.43S-A00AA4/800	<b>Article-Description</b> Profile 40×40, 4E-slots, S □□□□ .... Specifications for special profile machining
--	--	---

coding examples ↔ 1.1B







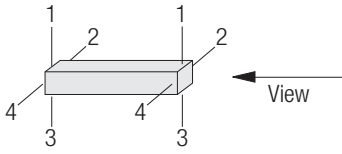





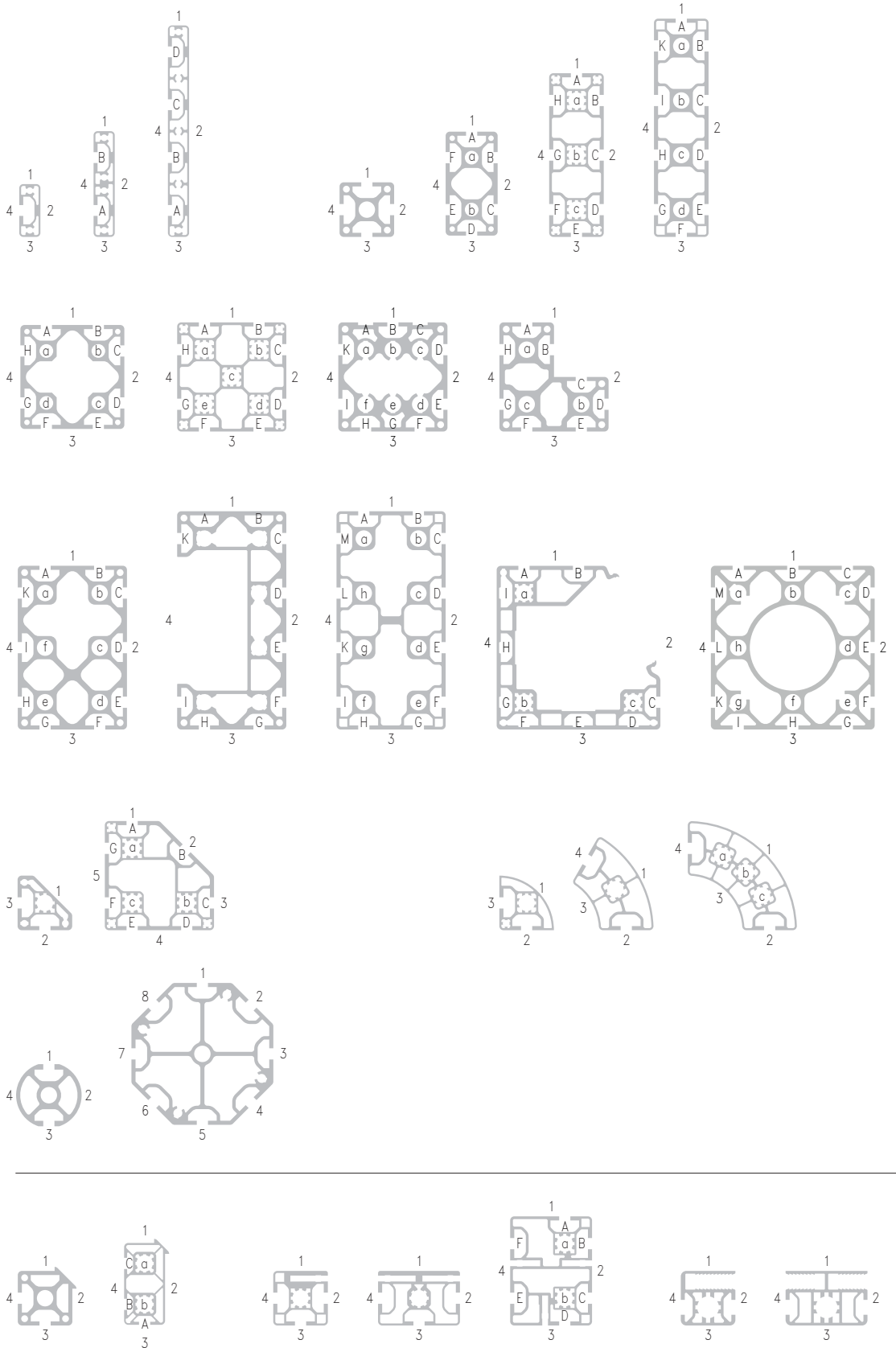







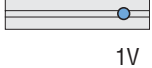





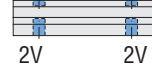

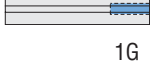
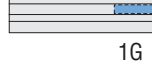
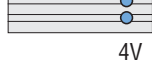
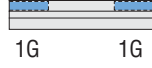
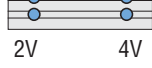
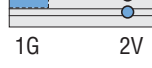
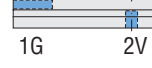



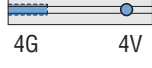



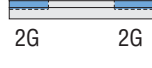
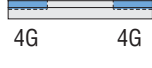
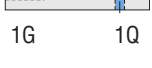

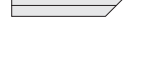



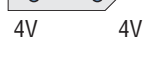



Direction and Position

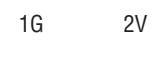

Description

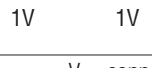
Direction: 1 - 4  
 Position of slot: A - M  
 Position of thread: a - h



Coding examples for price group 1			
			
 -A00A00	 -A00A00		 -A00A00
 -A00AA4 1V	 -A00AB4 2V	 -A00AB1 2V	 -A00AB4 2V
 -AA4AA4 1V 1V	 -AB4AB4 2V 2V	 -AB1AB1 2V 2V	 -AB4AB4 2V 2V
 -A00AL0 1G	 -A00AL0 1G		 -A00AD2 4V
 -AL0AL0 1G 1G	 -AL0AL0 1G 1G		 -AB4AD2 2V 4V
 -AL0AA4 1G 1V	 -AL0AB4 1G 2V	 -AL0AB1 1G 2V	 -AD2AD2 4V 4V
 -A00AQ1 1Q	 -AM0AB4 2G 2V	 -AM0AB1 2G 2V	 -AP0AD2 4G 4V
 -AA4AQ1 1V 1Q	 -A00AM0 2G		 -A00AP0 4G
 -AQ1AQ1 1Q 1Q	 -AM0AM0 2G 2G		 -AP0AP0 4G 4G
 -AL0AQ1 1G 1Q	 -AL0AM0 1G 2G		 -A00C00
 -A00C00	 -A00C00	<p>top view</p>  -A00E00	 -A00CD2 4V
 -A00CA4 1V	 -A00CB4 2V	 -A00EB1 2V	 -AD2CD2 4V 4V
 -AA4CA4 1V 1V	 -AB4CB4 2V 2V	 -AB1EB1 2V 2V	 -AD1CD1 4V 4V
 -AL0CA4 1G 1V	 -AL0CB4 1G 2V	 -AL0EB1 1G 2V	 -C00C00
 -C00C00	 -C00C00	 -E00E00	 -CD2CD2 4V 4V
 -CA4CA4 1V 1V	 -CB4CB4 2V 2V	 -EB1EB1 2V 2V	 -CD1CD1 4V 4V

V = connector bore, G = thread, Q = cross bore













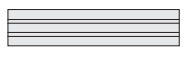

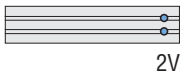
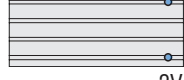

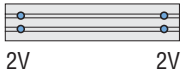
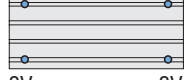
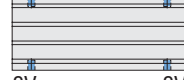
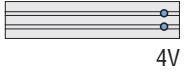
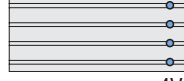
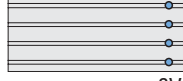
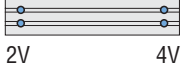

Coding examples for price group 2			
-F00F00	-F00F00		-F00F00
-F00FA4 1V	-F00FB4 2V	-F00FB1 2V	-F00FB4 2V
-FA4FA4 1V 1V	-FB4FB4 2V 2V	-FB1FB1 2V 2V	-FB4FB4 2V 2V
-F00FLO 1G	-F00FLO 1G		-F00FD2 4V
-FL0FLO 1G 1G	-FL0FLO 1G 1G		-FB4FD2 2V 4V
-FL0FA4 1G 1V	-FL0FB4 1G 2V	-FL0FB1 1G 2V	-FD2FD2 4V 4V
-F00FQ1 1Q	-FM0FB4 2G 2V	-FM0FB1 2G 2V	-FP0FD2 4G 4V
-FA4FQ1 1V 1Q	-F00FM0 2G		-F00FP0 4G
-FQ1FQ1 1Q 1Q	-FM0FM0 2G 2G		-FP0FP0 4G 4G
-FL0FQ1 1G 1Q	-FL0FM0 1G 2G		-F00H00
-F00H00	-F00H00	top view -F00K00	-F00HD2 4V
-F00HA4 1V	-F00HB4 2V	-F00KB1 2V	-FD2HD2 4V 4V
-FA4HA4 1V 1V	-FB4HB4 2V 2V	-FB1KB1 2V 2V	-FD1HD1 4V 4V
-FL0HA4 1G 1V	-FL0HB4 1G 2V	-FL0KB1 1G 2V	-H00H00
-H00H00	-H00H00	-K00K00	-HD2HD2 4V 4V
-HA4HA4 1V 1V	-HB4HB4 2V 2V	-KB1KB1 2V 2V	-HD1HD1 4V 4V

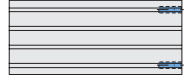
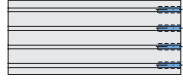
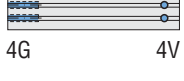
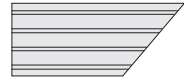
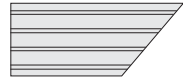
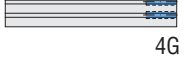
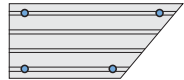
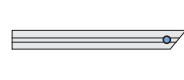
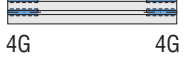
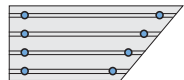
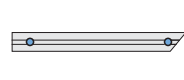
V = connector bore, G = thread, Q = cross bore

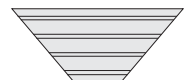
1

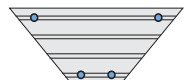

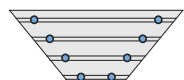
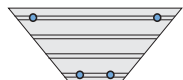
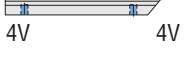
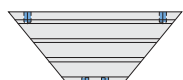
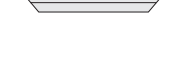
Coding examples for price group 3

		
 -L00L00	 -L00L00	 -L00L00
 -L00LB4 2V	 -L00LB4 2V	 -L00LB1 2V
 -LB4LB4 2V 2V	 -LB4LB4 2V 2V	 -LB1LB1 2V 2V
 -L00LD2 4V	 -L00LD4 4V	 -L00LH2 8V
 -LB4LD2 2V 4V	 -LD4LD4 4V 4V	 -LH2LH2 8V 8V
 -LD2LD2 4V 4V	 -L00LM0 2G	 -L00LU0 8G
 -LP0LD2 4G 4V	 -L00N00	 -L00N00
 -L00LP0 4G	 -LB4NB4 2V 2V	 -L00PB1 2V
 -LP0LP0 4G 4G	 -LD4ND4 4V 4V	 -LB1PB1 2V 2V
 -L00N00	 -N00N00	 -P00P00
 -LL0ND2 1G 4V	 -NB4NB4 2V 2V	 -PB1PB1 2V 2V
 -LD2ND2 4V 4V	 -ND4ND4 4V 4V	 -L00ND2 4V 4V
 -LD1ND1 4V 4V		 -ND1ND1 4V 4V
 -N00N00		
 -ND2ND2 4V 4V		
 -ND1ND1 4V 4V		

Order examples for special design

Article-No.	Description
① 1.11.□□□□□□.□□□□□□ -L00LD2	Profile □□□×□□□.□□□□□□ Connector position, right: CFIM (additional description)
② 1.11.□□□□□□.□□□□□□ -LD2LD2	Profile □□□×□□□.□□□□□□ Connector position, left: CFIM (additional description) Connector position, right: CFIM
③ 1.11.□□□□□□.□□□□□□ -L00ND2	Profile □□□×□□□.□□□□□□ Connector position, right: CFIM (additional description)
④ 1.11.□□□□□□.□□□□□□ -ND2ND2	Profile □□□×□□□.□□□□□□ Connector position, left: CFIM (additional description) Connector position, right: CFIM

V = connector bore, G = thread, Q = cross bore

**Extruded profile**  
**as per DIN EN 12020**  
 (fine)  
 (Replacement for DIN 17615)

Aluminium alloy Al Mg Si 0.5 F25  
 Material Nr. 3.3206.72 (low temp. annealed)

**Functional length: 6,000 mm**  
**Delivery length: 6,060 mm + 10 mm**

**Mechanical data**

(Values given in the direction of the press flow)  
 Tensile strength R<sub>m</sub>: min. 250 N/mm<sup>2</sup>  
 Elongation 0.2: min. 200 N/mm<sup>2</sup>  
 Pressure tension σ<sub>zul.</sub>: 95 N/mm<sup>2</sup>  
 Stress point A<sub>5</sub>: min. 10 %  
 Stress point A<sub>10</sub>: min. 8 %  
 E-Module: approx. 70,000 N/mm<sup>2</sup>  
 Brinell hardness: approx. 75 HB 2.5/187.5  
 Co-efficient of elongation: 23.8 x 10<sup>-6</sup>/K

Surface as per DIN 17611:  
 E6/EV1 - dull finish and anodised colours  
 Coat thickness approx. 10 μm  
 Coat hardness 250-350 HV  
 Special colours upon request.  
 The surface area - subject to technical procedure  
 - can show optical changes.

**Profile tolerance**  
 (Excerpt from DIN EN 12020-2)

Nominal dimensions:  
 The dimension deviation depends on the precision with which the tooling is manufactured, the tooling wear and the variation during the extrusion process. For one manufacturing setup the variation within one profile is 0.01 mm.

Profile tolerance		
Dim. range in mm		Tolerance in mm
from	to	
-	10	± 0.15
10	15	± 0.20
15	30	± 0.25
30	45	± 0.30
45	60	± 0.40
60	90	± 0.45
90	120	± 0.60
120	150	± 0.80
150	180	± 1.00
180	240	± 1.20
240	300	± 1.50

**Flatness of profile surfaces**

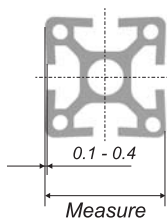

In order to optimize the connection stability, all profile surfaces are designed and manufactured with concave surfaces. This assures that the assembled profiles contact on the outer edges only (line of contact).  
 When tightening the connectors the slot flanks will be drawn to the mounting profile within the elastic range and will keep the connectors under tension.

**Straightness tolerance**  
 of the edge in longitudinal direction

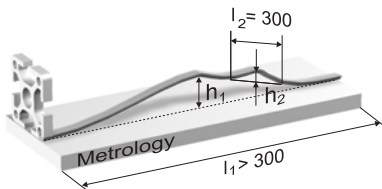

At a certain length l<sub>1</sub> the given tolerance h<sub>1</sub> is not to be exceeded.  
 For each incremental length of l<sub>2</sub> = 300 mm the deviation h<sub>2</sub> is not to exceed 0.3 mm.

Straightness tolerance		
Length l <sub>1</sub> in m		Tolerance h <sub>1</sub> in mm
from	to	
-	1	0.7
1	2	1.3
2	3	1.8
3	4	2.2
4	5	2.6
5	6	3.0

**Flatness tolerance**  
 (Twist tolerance)

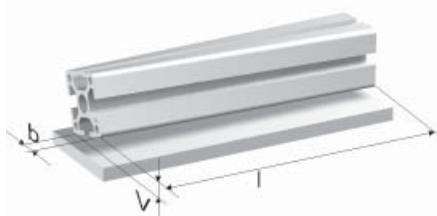

Width b in mm		Flatness tolerance					
Dim. range		at length l in m					
from	to	to 1	1 to 2	2 to 3	3 to 4	4 to 5	5 to 6
-	25	1.0	1.5	1.5	2.0	2.0	2.0
25	50	1.0	1.2	1.5	1.8	2.0	2.0
50	75	1.0	1.2	1.2	1.5	2.0	2.0
75	100	1.0	1.2	1.5	2.0	2.2	2.5
100	125	1.0	1.5	1.8	2.2	2.5	3.0
125	150	1.2	1.5	1.8	2.2	2.5	3.0
150	200	1.5	1.8	2.2	2.6	3.0	3.5
200	300	1.8	2.5	3.0	3.5	4.0	4.5

**Parallelism tolerance**  
(Angular tolerance)

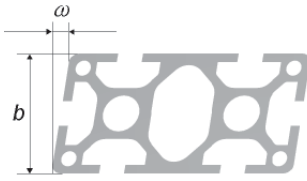

The parallelism tolerance  $\omega$  (angular tolerance) refers to unequal sides to the shorter side of the angle, i.e. it is measured from the longer side.

Parallelism tolerance		
Width $b$ in mm from	to	max. size tolerance $\omega$ in mm
-	30	0.3
30	50	0.4
50	80	0.5
80	100	0.6
100	120	0.7
120	140	0.8
140	160	0.9
160	180	1.0
180	200	1.2
200	240	1.5

**Bending strength**

For the computation of deflection use formulas on this page.

For the computation of deflection by the profiles own weight, apply "Type of load" 3, 6 or 9.

- $f$  = Deflection in mm
- $F$  = Type of load in N
- $l$  = Profile length in mm
- $J$  1) = Moment of inertia in mm<sup>4</sup>
- $E$  = Module of elasticity in N/mm<sup>2</sup>
- $E_{AL}$  = 70,000 N/mm<sup>2</sup>

**1) Comments**

- Catalogue data in cm<sup>4</sup>  
(Note factor of conversion 10<sup>4</sup> !)
- The moments of inertia of a certain profile are listed on the respective profile page (pages 1.09, 1.10, 1.11) and in the tables 1.1D

Type of load		
<b>1</b>		$f = \frac{F \cdot l^3}{3E \cdot J}$
<b>2</b>		$f = \frac{F \cdot l^3 + F_1 \cdot l_1^2 \cdot l + F_2 \cdot l_2^2 \cdot l}{3E \cdot J}$
<b>3</b>		$f = \frac{F \cdot l^3}{8E \cdot J}$
<b>4</b>		$f = \frac{F \cdot l^3}{48E \cdot J}$
<b>5</b>		$f = \frac{F \cdot l^3}{\left(48 + \frac{29m}{l}\right) \cdot E \cdot J}$
<b>6</b>		$f = \frac{5F \cdot l^3}{384E \cdot J}$
<b>7</b>		$f = \frac{F \cdot a^2 \cdot b^2}{3E \cdot J \cdot l}$
<b>8</b>		$f = \frac{F \cdot l^3}{192E \cdot J}$ <sup>2)</sup>
<b>9</b>		$f = \frac{F \cdot l^3}{384E \cdot J}$

<sup>2)</sup> approximate value

Approximate determination of deflection

To determine the approximation of deflection, use the diagram on this page.

Profile length  $l$  in mm

Determination of deflection

1. Type of load  $F$  in N
2. Profile length  $l$  in mm
3. Move cross point on the diagonal
4. Moment of inertia of the selected profile  $J$  in  $\text{cm}^4$
5. Cross point with the diagonal to be vertically extended to the bottom
6. Deflection  $f$  for the specific "Type of load" in mm

Example

- ①  $F = 2,000 \text{ N}$
- ②  $l = 1,000 \text{ mm}$
- ③ Move cross point on the diagonal
- ④  $J = 82.0 \text{ cm}^4$  for profile  $40 \times 80, 6E$
- ⑤ Cross point with the diagonal to be vertically extended to the bottom
- ⑥ Deflection for the specific "Type of load" in mm:

Type of load 1:  $f = 9.5 \text{ mm}$   
 Type of load 4:  $f = 0.6 \text{ mm}$   
 Type of load 8:  $f = 0.15 \text{ mm}$

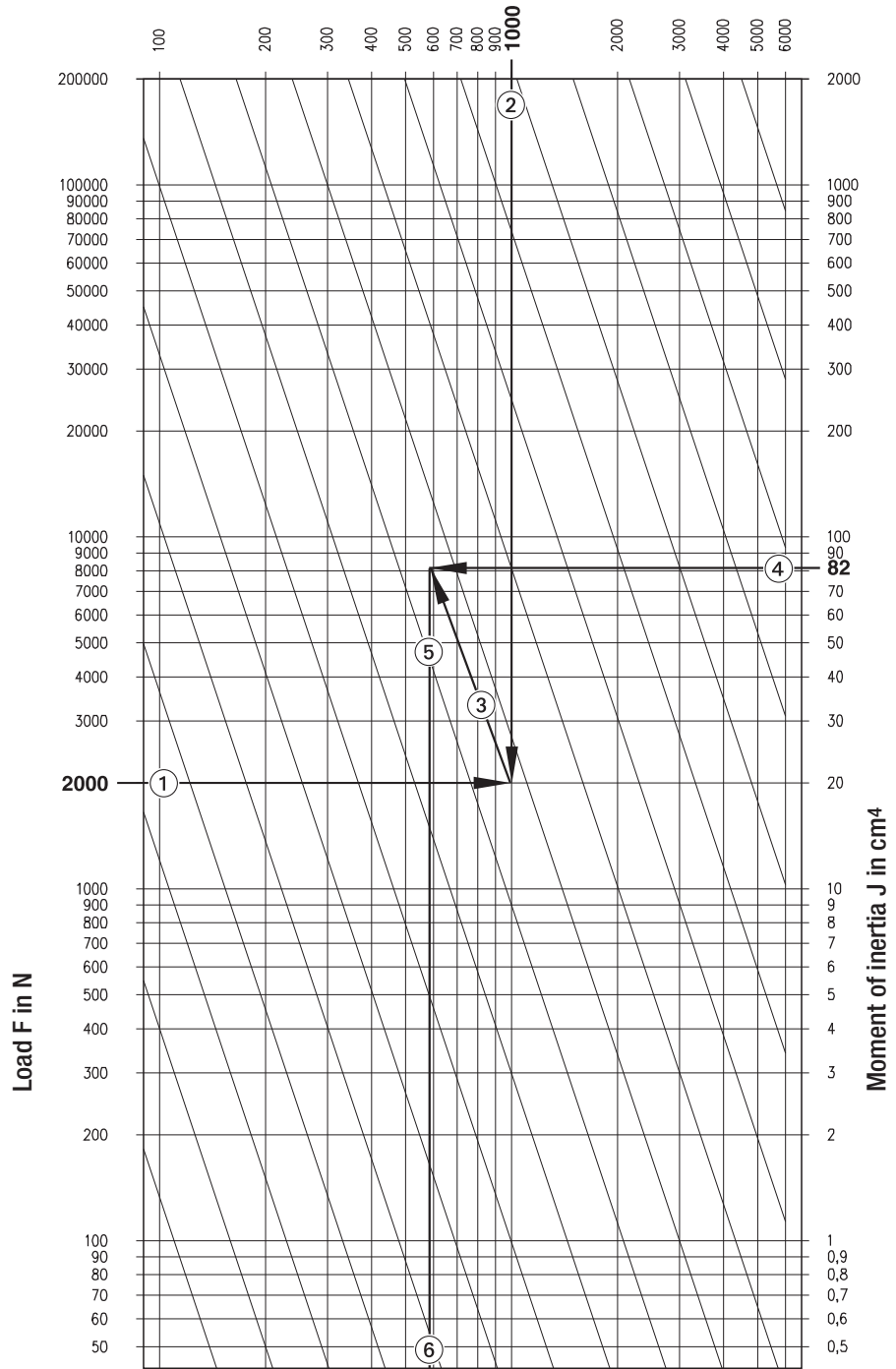

Type of load 1

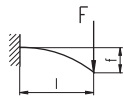

Type of load 4

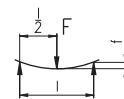



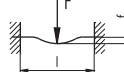



























Type of load 8















Deflection  $f$  in mm

































Design																				
16 F	16x40																			
E	16x40	16x80	16x160																	
20 H					20x20															
F				20x10												20x30	20x30	20x30		
30 F					30x30	30x30	30x30	30x30	30x30	30x30	30x30	30x30	30x30	30x30						30x50
E4																				
40 E3					40x40	40x40	40x40													
45 E4					45x45	45x45	45x45							45x60						
50 E4					50x50															
60 E4										60x60	60x60									60x90



	Profile	$I_x^{1)}$	$I_y^{1)}$	$W_x^{2)}$	$W_y^{2)}$	$G^{3)}$	$\beta$
	16x40, 1F, LP	4.4	0.8	2.2	0.8	0.87	14
	16x40, 1E, LP	4.3	0.8	2.2	0.8	0.75	13
	16x40, 1E, SP	7.2	1.1	3.6	1.1	1.14	13
	16x80, 2E, LP	30.7	1.6	7.7	1.6	1.49	13
	16x80, 2E, SP	48.3	2.2	12.0	2.2	2.11	13
	16x160, 4E, LP	221.0	3.2	27.5	3.2	2.6	13
	20x10, 1F, LP	0.1	0.6	0.2	0.5	0.35	17
	20x20, 2H, soft, SP	0.6	0.6	0.6	0.6	0.52	15
	30x30, 2F, soft, SP	2.7	2.7	1.6	1.6	0.9	18
	20x20, 2F, soft, S	2.7	2.7	1.6	1.6	0.9	36
	40x40, 2E, soft, LP	6.4	6.4	3.8	3.8	1.2	22
	40x40, 2E, soft, L	6.4	6.4	3.8	3.8	1.2	38
	45x45, 2E, soft, LP	11.4	11.4	5.1	5.1	1.6	30
	50x50, 2E, soft, S	18.8	18.8	7.5	7.5	2.3	42
	30x30, 0F, SP	4.4	4.4	2.3	2.3	1.3	18
	40x40, 0E, SP	12.6	12.6	6.3	6.3	2.0	22
	45x45, 0E, LP	15.5	15.5	6.9	6.9	2.2	30
	30x30, 1F, LP	3.1	3.1	2.1	2.1	0.9	18
	40x40, 1F, SP	4.3	4.0	2.9	2.6	1.2	18
	40x40, 1E, LP	10.1	9.8	5.0	4.8	1.5	22
	45x45, 1E, LP	14.7	15.5	6.5	6.8	2.1	30
	30x30, 2F, cor., SP	3.7	3.2	2.4	2.1	1.1	18
	30x30, 2F, cor., S	3.7	3.2	2.4	2.4	1.1	36
	20x20, 2H, cor., SP	1.0	1.0	0.9	0.9	0.68	15
	30x30, 2F, cor., LP	3.2	3.2	2.1	2.1	0.9	18
	30x30, 2F, cor., SBP	3.7	3.7	2.4	2.4	1.1	18
	30x30, 2F, cor., L	3.2	3.2	2.1	2.1	0.9	36
	30x30, 2F, cor., SB	3.7	3.7	2.4	2.4	1.1	36
	40x40, 2E, cor., LP	9.9	9.9	4.9	4.9	1.5	22
	40x40, 2E, cor., SP	12.0	12.0	6.0	6.0	2.0	22
	40x40, 2E, cor., L	8.0	8.0	4.0	4.0	1.3	38
	40x40, 2E, cor., S	12.3	12.3	6.1	6.1	2.0	38
	45x45, 2E, cor., LP	14.7	14.7	6.6	6.6	2.0	30
	50x50, 2E, cor., L	16.5	16.5	6.7	6.7	1.7	42
	50x50, 2E, cor., S	27.4	27.4	10.9	10.9	3.0	42
60x60, 2E, cor., SP	57.2	57.2	19.1	19.1	4.3	34	
	20x20, 2H, LP	1.0	0.8	1.0	0.8	0.58	15
	30x30, 2F, LP	3.2	3.2	2.1	2.1	0.9	19
	30x30, 2F, SP	3.6	3.9	2.4	2.6	1.1	19
	30x30, 2F, L	3.2	3.2	2.2	2.2	0.9	36
	40x40, 2E, LP	8.2	7.5	4.1	3.8	1.3	23
	40x40, 2E, L	8.2	7.5	4.1	3.8	1.3	38
	45x45, 2E, LP	14.0	15.5	6.2	6.9	2.0	31
	50x50, 2E, L	17.7	13.6	7.0	5.4	1.6	42

	Profile	$I_x^{1)}$	$I_y^{1)}$	$W_x^{2)}$	$W_y^{2)}$	$G^{3)}$	$\beta$
	60x60, 2E, LP	35.1	37.7	11.7	12.5	2.9	34
	60x60, 2E, SP	55.9	58.5	18.6	19.5	4.3	34
	20x20, 3H, SP	0.9	0.9	0.9	0.9	0.65	15
	30x30, 3F, LP	3.0	3.0	2.0	2.0	0.9	19
	30x30, 3F, SP	3.5	3.7	2.4	2.4	1.1	19
	30x30, 3F, L	3.3	3.2	2.2	2.2	0.9	36
	30x30, 3F, S	3.5	3.7	2.4	2.4	1.1	36
	40x40, 3E, LP	9.5	9.9	4.7	4.9	1.5	23
	40x40, 3E, SP	12.0	11.4	6.0	5.6	2.0	23
	40x40, 3E, L	8.3	8.8	4.1	4.4	1.4	38
	40x40, 3E, S	12.0	11.3	6.0	5.6	2.0	38
	45x45, 3E, LP	14.0	14.7	6.2	6.5	2.1	31
	50x50, 3E, L	18.4	16.0	7.3	5.8	1.9	42
	50x50, 3E, S	27.3	28.2	11.1	11.1	3.1	42
	20x20, 4H, LP	0.8	0.8	0.8	0.8	0.53	16
	20x20, 4H, SP	0.9	0.9	0.9	0.9	0.62	16
	30x30, 4F, LP	3.3	3.3	2.2	2.2	0.9	19
	30x30, 4F, SP	3.5	3.5	2.4	2.4	1.1	19
	30x30, 4F, L	3.3	3.3	2.2	2.2	0.9	37
	30x30, 4F, S	3.5	3.5	2.4	2.4	1.1	37
	40x40, 4E, LP	9.6	9.6	4.7	4.7	1.5	23
	40x40, 4E, SP	12.0	12.0	6.0	6.0	2.0	23
	40x40, 4E, L	9.9	9.9	4.9	4.9	1.5	39
	40x40, 4E, S	12.0	12.0	6.0	6.0	2.0	39
	45x45, 4E, LP	13.5	13.5	6.0	6.0	1.9	31
	45x45, 4E, SP	15.5	15.5	6.9	6.9	2.1	31
45x45, 4E, L	13.5	13.5	6.0	6.0	1.9	41	
45x45, 4E, S	16.8	16.8	7.4	7.4	2.3	41	
	50x50, 4E, L	19.2	19.2	7.7	7.7	2.2	43
	50x50, 4E, S	27.3	27.3	11.0	11.0	3.1	43
	60x60, 4E, LP	35.5	35.5	11.7	11.7	2.7	34
	60x60, 4E, SP	56.0	56.0	18.7	18.7	4.2	34
	45x60, 4E, L	35.5	35.5	11.7	11.7	2.7	44
	45x60, 4E, S	56.0	56.0	18.7	18.7	4.2	44
	45x60, 4E, LP	26.5	16.0	9.0	7.2	2.3	31
	45x60, 4E, L	26.5	16.0	9.0	7.2	2.3	42
	20x30, 1F, LP	2.2	1.4	1.5	1.4	0.7	17
	20x30, 1F, LBP	3.9	1.4	2.6	1.3	1.2	17
	20x30, 2F, LP	2.2	1.5	1.5	1.5	0.74	17
	20x30, 2F, SP	2.6	1.9	1.7	1.7	1.0	17
	60x90, 6E, L	125.8	54.3	27.9	18.1	3.9	44
	60x90, 6E, S	193.0	83.0	43.0	27.5	6.0	44
	30x50, 4F, LP	10.6	4.7	4.6	3.6	1.3	19
	30x50, 4F, SP	16.3	6.4	6.5	4.3	1.9	19
	30x50, 4F, L	10.5	4.5	4.5	3.5	1.3	37
	30x50, 4F, S	16.1	6.3	6.4	4.2	1.9	37















<sup>1)</sup>  $I_x, I_y$  = moment of inertia in  $cm^4$ 
<sup>2)</sup>  $W_x, W_y$  = moment of resistance in  $cm^3$ 
<sup>3)</sup>  $G$  = weight in  $kg/m$



























Design																				
PG slot																				
16 F																				
E																				
20 H			20x40				20x40													
F																				
30 F	30x60						30x60													
E4									30x100											30x150
40 E3	40x80	40x80		40x80	40x80	40x80	40x80						40x160	40x160						
45 E4	45x90						45x90													
50 E4							50x100	50x100	50x150											
60 E4																				



	Profile	lx <sup>1)</sup>	ly <sup>1)</sup>	Wx <sup>2)</sup>	Wy <sup>2)</sup>	G <sup>3)</sup>	↳	
	30x60, 0F, SP	29.0	7.8	9.6	5.2	2.2	19	
	40x80, 0E, LP	66.8	18.4	16.7	9.2	2.7	23	
	45x90, 0E, LP	107.5	30.4	23.9	13.5	3.6	31	
	40x80, 0E, SP	134.3	36.3	29.8	16.2	4.7	31	
	40x80, 3E, cor., LP	66.9	18.1	16.7	9.0	2.6	23	
	20x40, 4H, SP	7.0	2.0	3.5	2.0	1.3	16	
	40x80, 4E, LP	65.8	18.1	16.5	9.0	2.6	24	
	4E, L	63.2	17.8	15.7	8.9	2.6	39	
	40x80, 4E, LBP	74.5	18.3	18.6	9.2	2.8	24	
	40x80, 5E, LP	72.2	18.1	18.0	9.0	2.8	24	
	20x40, 6H, LP	5.3	1.4	2.6	1.4	0.9	16	
	6H, SP	6.4	1.7	3.2	1.7	1.3	16	
	30x60, 6F, LP	6F, LP	22.1	5.9	7.4	3.9	1.6	19
		6F, SP	25.0	7.0	8.3	4.7	2.1	19
		6F, L	21.9	5.8	7.4	3.8	1.6	37
	6F, S	25.0	7.0	8.3	4.7	2.1	37	
	40x80, 6E, LP	6E, LP	65.4	17.5	16.4	8.8	2.5	24
		6E, SP	82.0	23.4	20.5	11.7	3.8	24
		6E, L	62.7	17.0	15.6	8.5	2.6	39
	6E, S	82.0	23.4	20.5	11.7	3.8	39	
	45x90, 6E, LP	6E, LP	98.0	27.5	21.8	12.2	3.3	32
		6E, SP	126.0	34.0	28.0	15.0	4.4	32
		6E, L	98.0	27.5	21.8	12.2	3.3	41
	6E, S	126.0	34.0	28.0	15.0	4.4	41	
	50x100, 6E, L	6E, L	138.0	37.0	27.5	14.5	3.5	43
6E, S		202.0	57.2	40.4	22.8	5.9	43	
	50x100, 8E, L	137.0	40.0	27.5	16.0	4.0	43	
	50x100, 8E, S	200.0	53.3	39.9	21.3	6.0	43	
	40x120, 8E, LP	200.4	25.4	33.4	12.7	3.8	25	
	8E, L	198.5	25.2	34.2	12.6	3.6	39	
	50x150, 8E, S	628.0	83.0	83.0	33.0	8.1	43	
	30x100, 3F, SP	120.4	12.8	24.0	8.5	3.6	20	

	Profile	lx <sup>1)</sup>	ly <sup>1)</sup>	Wx <sup>2)</sup>	Wy <sup>2)</sup>	G <sup>3)</sup>	↳
	30x100, 8F, SP	115.0	11.6	22.9	7.7	3.4	20
	30x100, 10F, SP	127.0	11.9	25.4	7.9	3.6	20
	40x160, 6E, LP	450.4	36.3	56.3	18.1	5.0	25
	40x160, 10E, LP	433.5	33.1	54.2	16.5	4.7	25
	30x150, 8F, SP	340.0	16.0	45.0	11.0	4.1	21
	30x150, 8E, SP	481.0	25.1	64.1	16.7	7.9	21
	30x150, 8E, SP	481.0	25.1	64.1	16.7	7.9	21

















<sup>1)</sup> lx, ly = moment of inertia in cm<sup>4</sup>
<sup>2)</sup> Wx, Wy = moment of resistance in cm<sup>3</sup>
<sup>3)</sup> G = weight in kg/m







Design	PG slot															
16	F															
	E															
20	H															
	F															
30	F					60×60		60×60								
	E4															
40	E3	80×80	80×80	80×80	80×80	80×80	80×80	80×80	80×120	80×160	80×160	80×160	120×120	120×120		
45	E4					90×90	90×90									
50	E4					100×100	100×100					100×200				
60	E4															







Profile	ix <sup>1)</sup>	ly <sup>1)</sup>	Wx <sup>2)</sup>	Wy <sup>2)</sup>	G <sup>3)</sup>	↳
 80×80, 0E, LP	135.0	135.0	33.5	33.5	4.7	26
 80×80, 4E, cor., LP	128.0	128.0	32.0	32.0	4.5	26
 80×80, 6E, LP	121.3	116.0	30.3	29.0	4.2	26
 80×80, 7E, SP	162.8	149.7	40.7	37.5	6.2	26
 60×60, 8F, L	38.7	38.7	12.9	12.9	2.6	37
 80×80, 8E, LP	114.0	114.0	28.4	28.4	4.1	26
 8E, SP	166.0	166.0	41.4	41.4	5.9	26
 8E, L	111.0	111.0	28.0	28.0	4.1	40
 8E, S	166.0	166.0	41.4	41.4	5.9	40
 90×90, 8E, LP	190.5	190.5	42.3	42.3	5.6	32
 100×100, 8E, S	411.0	411.0	82.0	82.0	9.7	43
 80×80, 8E, LBP	118.7	118.7	29.9	29.9	4.9	27
 8E, LB	110.2	110.2	27.6	27.6	4.5	40
 90×90, 8E, SP	282.0	282.0	63.0	63.0	9.5	32
 100×100, 8E, L	254.1	254.1	45.4	45.4	6.2	43
 60×60, 8F, angle, S	35.2	35.2	9.9	9.9	2.8	37
 80×80, 8E, angle, SP	120.0	120.0	23.8	23.8	5.4	27
 8E, angle, S	120.0	120.0	23.8	23.8	5.4	40
 80×120, 10E, SP	449.9	217.8	72.6	54.4	8.6	27
 80×160, 8E, SP	944.0	183.0	118.0	45.8	7.9	27
 80×160, 8E, LP	828.0	259.0	104.0	65.0	8.6	27
 80×160, 12E, LP	787.6	231.9	98.3	58.2	8.2	27
 12E, SP	883.0	269.0	110.0	67.3	9.4	27
 12E, L	794.0	233.0	99.3	58.3	8.8	40
 12E, S	880.0	268.0	110.0	67.0	9.4	40
 100×200, 12E, SP	2,450.0	760.0	250.0	152.0	17.2	33

















Profile	ix <sup>1)</sup>	ly <sup>1)</sup>	Wx <sup>2)</sup>	Wy <sup>2)</sup>	G <sup>3)</sup>	↳
 120×120, 3E, LP	538.3	275.2	89.8	45.8	6.7	54
 120×120, 12E, SP	624.0	624.0	104.0	104.0	10.6	27









<sup>1)</sup> ix, ly = moment of inertia in cm<sup>4</sup>
<sup>2)</sup> Wx, Wy = moment of resistance in cm<sup>3</sup>
<sup>3)</sup> G = weight in kg/m









Design	PG slot																
16	F																
	E																
20	H																
	F																
30	F																
	E4																
40	F																
	E3	40x40	80x80	40x30°		40x45°	40x60°	40x90°									
45	E4																
50	E4																
60	E4																

Profile	ix <sup>1)</sup>	ly <sup>1)</sup>	Wx <sup>2)</sup>	Wy <sup>2)</sup>	G <sup>3)</sup>	↔
 40x40, 2E, 45°, LP	7.3	7.3	3.9	3.9	1.4	29
 80x80, 7E, 45°, LP	99.3	99.3	24.8	24.8	4.0	29
 40, round 30°, 2F, LP	6.0	4.8	3.0	2.4	1.2	28
 40, round 45°, 2E, LP	14.5	8.0	4.9	3.7	1.6	28
 40, round 60°, 2E, LP	30.0	10.5	7.6	4.6	1.9	28

Profile	ix <sup>1)</sup>	ly <sup>1)</sup>	Wx <sup>2)</sup>	Wy <sup>2)</sup>	G <sup>3)</sup>	↔
 40, round 90°, 2E, LP	89.0	89.0	16.0	16.0	3.0	28
 48, round, 1E, SP	12.5	12.9	4.9	5.4	1.8	45
 48, round, 2E, cor., SP	12.0	12.0	5.0	5.0	2.0	45
 48, round, 2E, SP	12.5	13.5	5.1	5.9	2.0	45
 30, octag., 8F, SP	84.0	84.0	21.0	21.0	3.9	45
 40, octag., 8E, SP	176.6	176.6	35.3	35.3	5.8	45

Design	PG slot																
16	F																
	E																
20	H																
	F																
30	F	30x30	30x30	30x30	30x30		30x45	30x50	30x50								
	E4																
40	E3		40x40	40x40	40x40		40x60		40x60	60x80	60x80						
45	E4																
50	E4			50x50		50x50											
60	E4																

Profile	ix <sup>1)</sup>	ly <sup>1)</sup>	Wx <sup>2)</sup>	Wy <sup>2)</sup>	G <sup>3)</sup>	↔
 30x30, 0F, P, LP	3.8	3.8	2.4	2.4	1.10	46
 30x30, 2F, P, LP 5	4.3	3.3	2.8	2.2	1.20	46
 30x30, 2F, P, LP 6	3.6	2.8	2.4	1.9	1.00	46
 30x30, 2F, WG, LP 7.5	2.6	3.2	1.7	2.1	0.86	49
 40x40, 2E, WG, LP 7.5	7.5	8.2	3.8	4.1	1.35	49
 30x30, 2F, c., P, LP 4	3.3	3.3	2.2	2.2	1.00	46
 40x40, 2E, c., P, LP 4	10.3	10.3	5.2	5.2	1.80	47
 50x50, 2E, c., P, LP 4	19.4	19.4	7.6	7.6	2.40	48
30x30, 3F, P, LP 4	3.3	2.8	2.2	1.8	0.90	46
40x40, 3E, P, LP 4	10.2	8.7	5.1	4.3	1.65	47
50x50, 3E, P, LP 4	24.1	21.4	8.0	8.5	2.70	48
40x40, 2E, 45°, SP	12.1	12.1	6.1	6.1	2.10	46

Profile	ix <sup>1)</sup>	ly <sup>1)</sup>	Wx <sup>2)</sup>	Wy <sup>2)</sup>	G <sup>3)</sup>	↔
 30x45, 2F, WG, LP 7.5	4.3	7.4	2.9	3.3	1.15	49
 40x60, 2E, 1F, WG, LP 7.5	12.2	22.5	6.1	7.5	1.97	49
 30x50, 2F, P, LP 5	7.0	14.7	4.7	5.9	1.90	46
 30x50, 3F, P, LP 4	5.5	11.8	3.6	4.8	1.5	46
 40x60, 3E, P, LP 4	14.8	26.3	7.4	8.8	2.4	47
 30x60, 3F, 45°, LP	22.8	6.1	7.6	4.0	1.7	46
 60x80, 5E, P, LP 4	100.4	50.4	25.1	16.8	3.8	47
 60x80, 6E, P, LP 4	88.1	52.0	22.1	17.3	3.7	47

<sup>1)</sup> Ix, Iy = moment of inertia in cm<sup>4</sup>
<sup>2)</sup> Wx, Wy = moment of resistance in cm<sup>3</sup>
<sup>3)</sup> G = weight in kg/m



Profile combinations

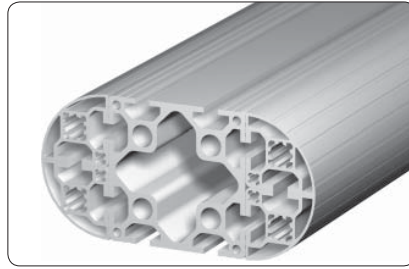

With the MayTec Connector System it is possible to make a multitude of form-matching and stable profile combinations.

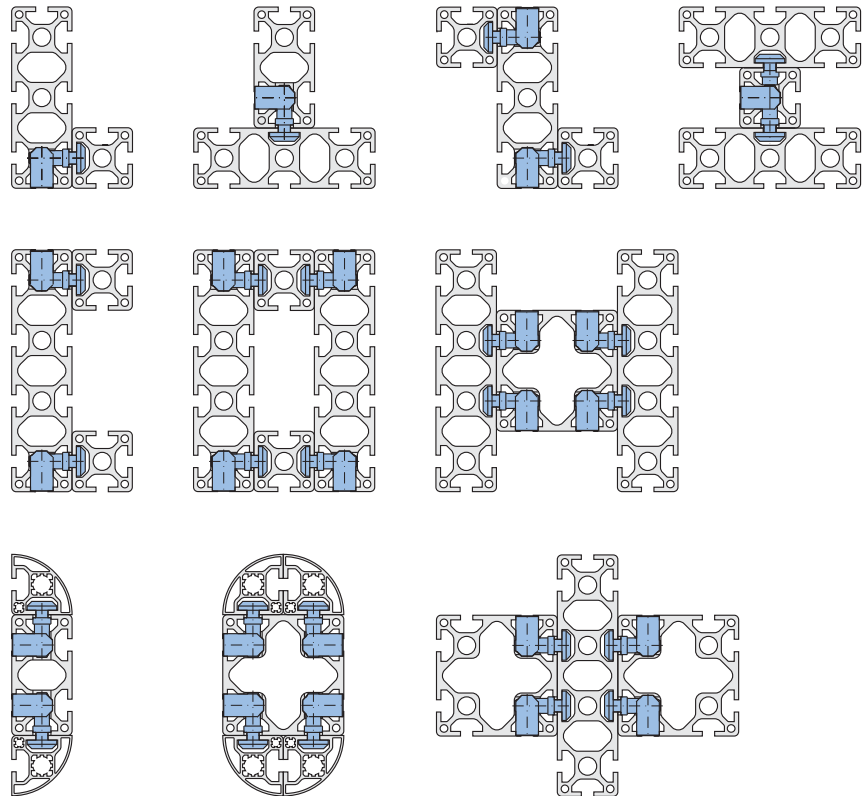

Special slits

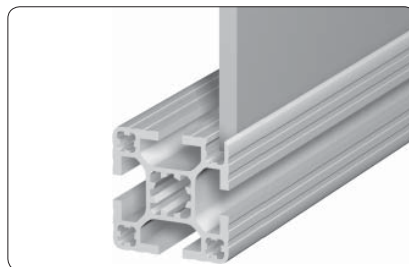

Panel elements can be set in the profile flush to the outer edge for form-matching design. The slits needed for that can be made in nearly all profiles.

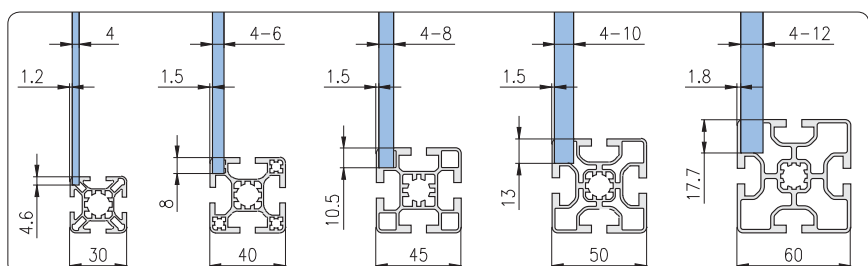

Slot plates

F-slot

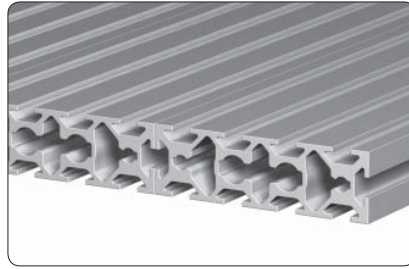

F-slot, slot distance 25 mm

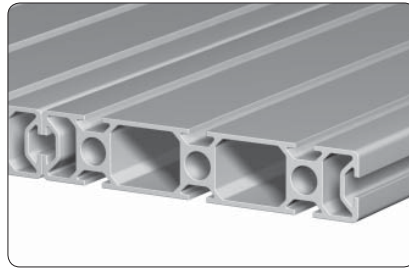

F-slot, slot distance 50 mm

E-slot

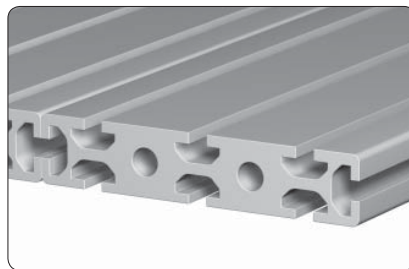

E-slot, slot distance 50 mm

**Application**

Profiles to construct slot plates of any required size



Slot plates F-slot  
Slot distance 25 mm

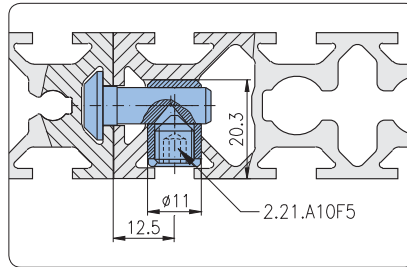
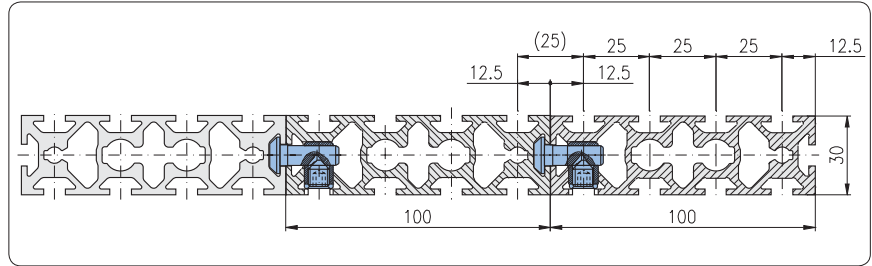

Drill dimensions

Single parts

- anchor 2.21.A10F5
- cross bushing 2.21.B10

Profile 30×100, 10F, SP

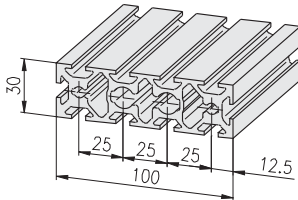

Description

Profile 30×100, 10F, SP

Weight

bar 6 m

3.6 kg/m

Article-No.

1.11.030100.104SP.60

Slot plates F-slot  
Slot distance 50 mm

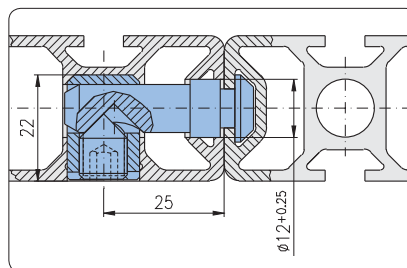
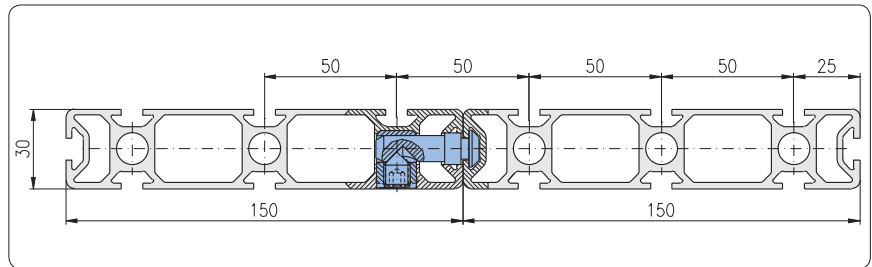

Drill dimensions

Single parts

- anchor 1.21.A5F5
- cross bushing 1.21.B30

Profile 30×150, 8F, SP

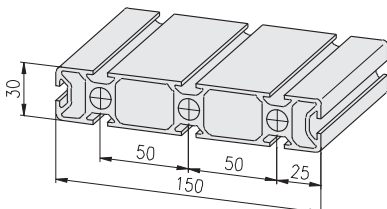

Description

Profile 30×150, 8F, SP

Weight

bar 6 m

4.1 kg/m

Article-No.

1.11.030150.85SP.60

Slot plates E-slot  
Slot distance 50 mm

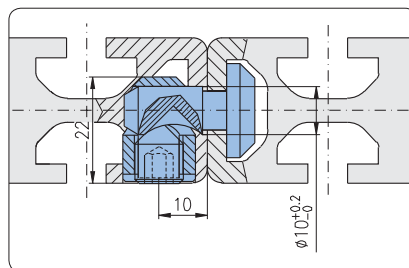
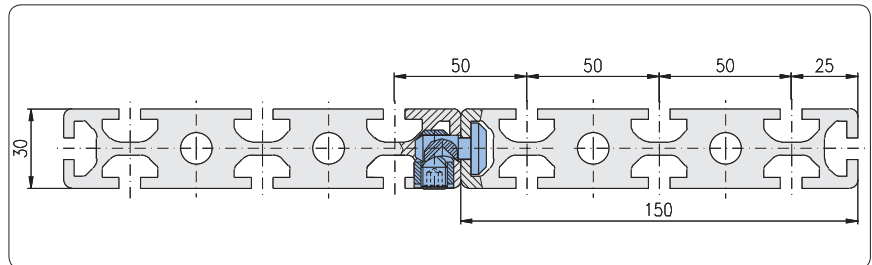

Single parts

- anchor 1.21.A2E5
- cross bushing 1.21.B34

Drill dimensions

Profile 30×150, 8E, SP

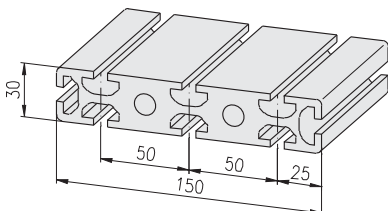

Description

Profile 30×150, 8E, SP

Weight

bar 6 m 7.9 kg/m

Article-No.

1.11.030150.84SP.60

machining data Profile machining 1.1A

Hand rail



Post: Profile 40×40

**Application**

Hand rail for balustrades on stairs and platforms

**Comments**

Angled joints: 0 deg. to 90 deg.  
Incline: 0 deg. to 45 deg.



Hand rail straight

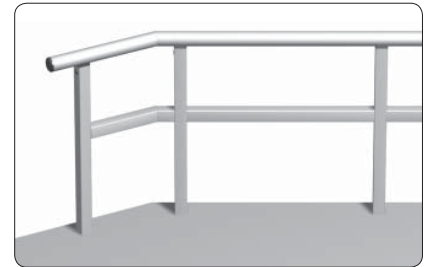

Hand rail angled



Hand rail tilted

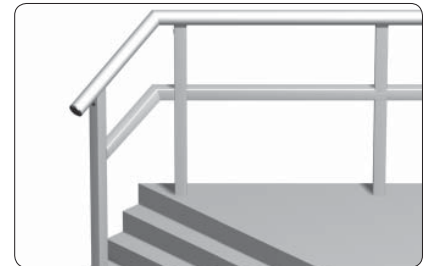

Hand rail tilted and angled

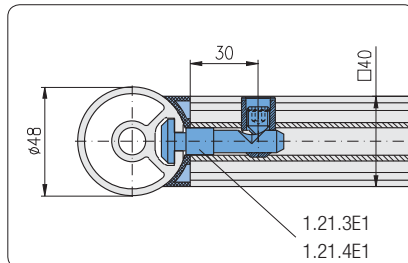

Working dimensions for hand rail straight with radius compensation

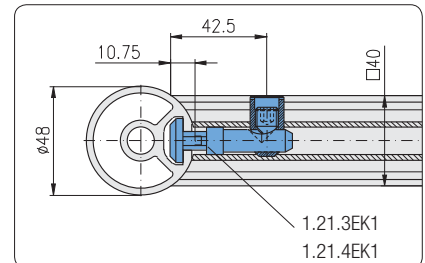

Working dimensions for hand rail straight, tilted and/or angled without radius compensation (milled)

Hand rail

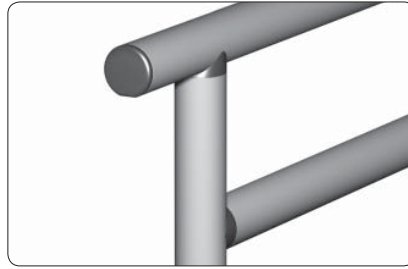

Post: Profile Ø48

**Application**

Hand rail for balustrades on stairs and platforms

**Comments**

Angled joints: 0 deg. to 90 deg.

Incline: 0 deg. to 45 deg.

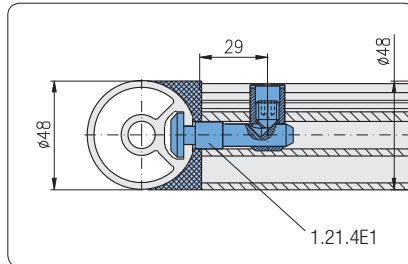

Working dimensions for hand rail straight with radius compensation

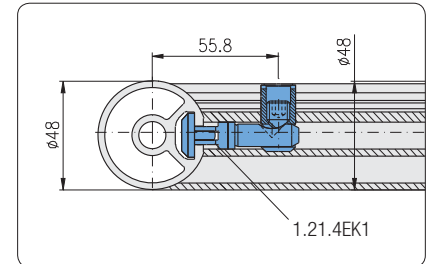

Working dimensions for hand rail straight, tilted and/or angled without radius compensation (milled)



U-Profile 40



**Application**

For the construction of height adjustable frames on 40×40 and 40×80 profile bases

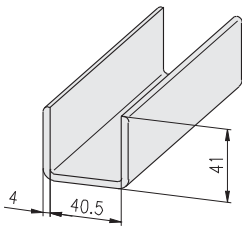
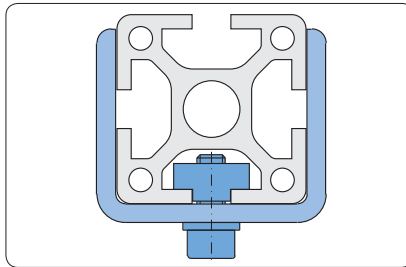

Description	Weight	Article-No.
U-Profile 40	bar 6 m 1.35 kg/m	1.19.14440.60

Profiles for cable guide

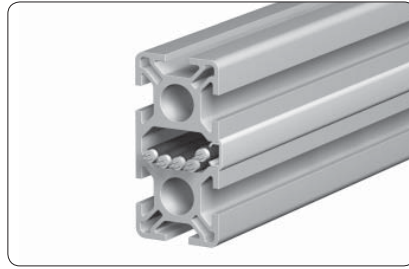

**Application**

For running cables or pneumatic hoses.  
All chamber profiles can be delivered with open slots.

Cover is carried out by cover profiles:

Cover profile PVC 1.41.11□

Cover profile ALU 1.41.121

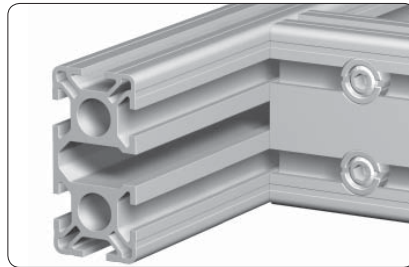

Application of cross braces to stabilize slotted profiles

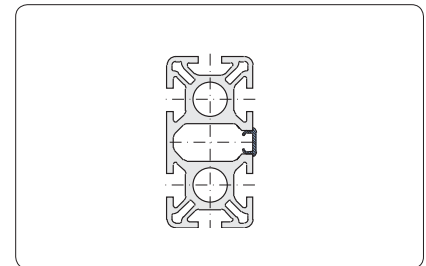
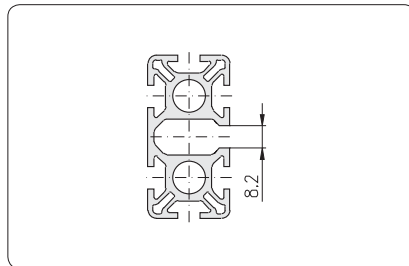

- 16
- 20
- 30
- 40
- 45
- 50
- 60

**Comments**

Profiles for cable guide see list at profile pre-cut lid

**Order details**

**Description**

**Article-No.**

Profile □□□□□□,	1.11.□□□□□□.□□
slotted 8 mm, special machining as per drawing	SBZ1

**Order example**

**Order request**

Profile 40×80 mm, 6 E-slots, heavy, 8 mm slotted, length 4.5 m

**Order**

Profile 40×80, 6E S,  
slotted 8 mm, special machining as per drawing

1.11.040080.64S-F00F00/4500  
SBZ1





Profiles for cable guide  
Slot distance 30

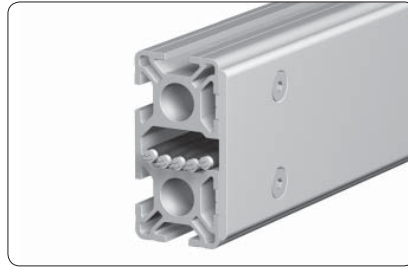

**Application**

For running cables or pneumatic hoses.  
All chamber profiles can be delivered with open slots.

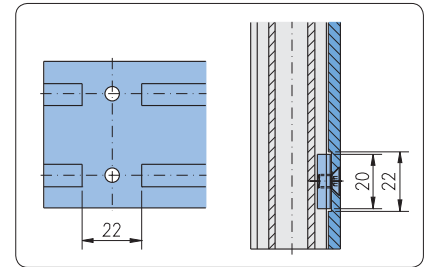
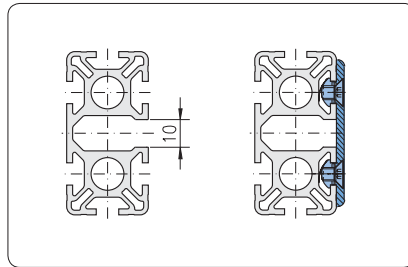

Milled section on the pre-cut lid for fastening with T-Nut in F-slot

Profiles for cable guide, slot distance 30				
Profile	light, plain	heavy, plain	light	heavy
30x60	6F LP	OF SP  6F SP	6F L	6F S
60x60		OF SP	8F L	8F angle S

**Order details**

**Description**

**Article-No.**

Profile □□□□□□,	1.11.□□□□□□.□□
slotted 10 mm, special machining as per drawing	SBZ2

**Order example**

**Order request**

Profile 30x60 mm, 6 F-slots, heavy, 10 mm slotted, length 4.5 m

**Order**

Profile 30x60, 6F S,	1.11.030060.65S-A00A00/4500
slotted 10 mm, special machining as per drawing	SBZ2

**Profile pre-cut lid 30**

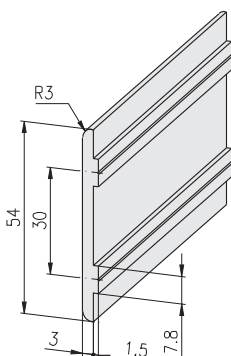

**Single parts**

- countersunk screw DIN 7991, M5x8 0.63.D07991.05008
- threaded plate F, M5 1.31.FM5
- T-Nut for subsequent insertion F, M5 1.32.4FM5

**Description**

**Weight**

**Article-No.**

Profile pre-cut lid 30	0.49 kg/m	1.19.110130
------------------------	-----------	-------------

machining data Profile machining 1.1A

Profiles for cable guide  
Slot distance 40

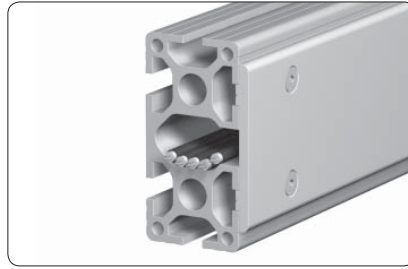

**Application**

For running cables or pneumatic hoses.  
All chamber profiles can be delivered with open slots.

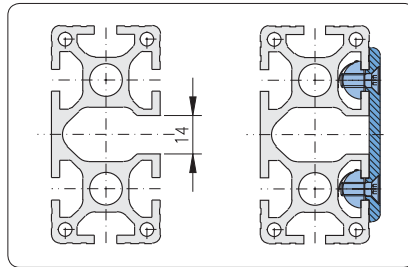

Profiles for cable guide, slot distance 40										
Profile	light, plain					heavy, plain	light		heavy	
40x80	0E LP	3E c.LP	4E LP	4E LBP	5E LP	6E LP	6E SP	4E L	6E L	6E S
80x80	0E LP	4E c.LP	6E LP	8E LP	8E LBP	7E SP	8E L	8E LB	8E S	
	7E 45° LP					8E SP	8E ang. SP			8E angle S
	40x160	80x160	80x120	80x160	120x120	40x120	80x160	80x160	80x160	
	6E LP	10E LP	8E LP	12E LP	10E SP	12E SP	12E SP	8E L	12E L	12E S

**Order details**

**Description**

**Article-No.**

Profile □□□□□□,	1.11.□□□□□□.□□
slotted 14 mm, special machining as per drawing	SBZ3

**Order example**

**Order request**

Profile 80x80 mm, 8 E-slots, heavy, 14 mm slotted, length 4.5 m

**Order**

Profile 80x80, 8E S,	1.11.080080.83S-L00L00/4500
slotted 14 mm, special machining as per drawing	SBZ3

**Profile pre-cut lid 40**

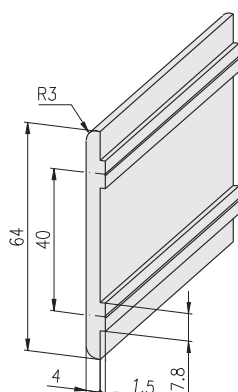

**Single parts**

- countersunk screw DIN 7991, M6x14 0.63.D07991.06014
- threaded plate E, M6 1.31.EM6
- T-Nut for subsequent insertion E, M6 1.32.4EM6

**Description**

**Weight**

**Article-No.**

Profile pre-cut lid 40	0.74 kg/m	1.19.110140
------------------------	-----------	-------------

machining data Profile machining 1.1A

Profiles for cable guide  
Slot distance 50

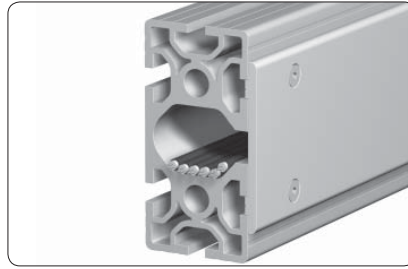

**Application**

For running cables or pneumatic hoses.  
All chamber profiles can be delivered with open slots.

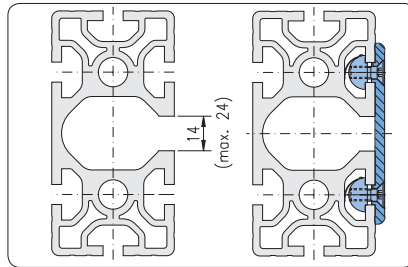

Profiles for cable guide, slot distance 50										
heavy, plain				light		heavy				
30x100		30x150		100x200		50x100	100x100	50x100	50x150	100x100
3F SP	8F SP	8F SP	12E SP	6E L	8E L	6E S	8E S	8E S		

**Order details**

**Description**

**Bestell-Nr.**

Profile □□□□□□,	1.11.□□□□□□.□□
slotted 14 mm, special machining as per drawing	SBZ4

**Order example**

**Order request**

Profile 50x100 mm, 6 E-slots, heavy, 14 mm slotted, length 4.5 m

**Order**

Profile 50x100, 6E S, slotted 14 mm, special machining as per drawing	1.11.050100.65S-F00F00/4500 SBZ4
--	-------------------------------------

**Profile pre-cut lid 50**

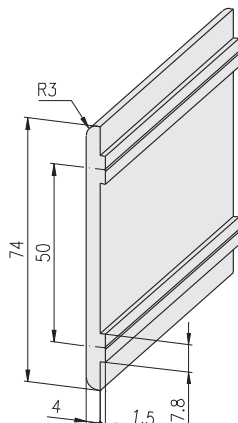

**Single parts**

F-slot

- countersunk screw DIN 7991, M5x8 0.63.D07991.05008
- threaded plate F, M5 1.31.FM5
- T-Nut for subsequent insertion F, M5 1.32.4FM5

E-slot

- countersunk screw DIN 7991, M6x14 0.63.D07991.06014
- threaded plate E, M6 1.31.EM6
- T-Nut for subsequent insertion E, M6 1.32.4EM6

**Description**

**Weight**

**Article-No.**

Profile pre-cut lid 50	0.85 kg/m	1.19.110150
------------------------	-----------	-------------

machining data Profile machining 1.1A

Curved profiles

For curved profiles the following data is required:

- Profile type (current conditions see table below)
- Position of profile ↗ 59
- Radius
- Direction ↗ 61
- Necessary accuracy of dimensions for curved profiles and for all required functionality



Position of profile

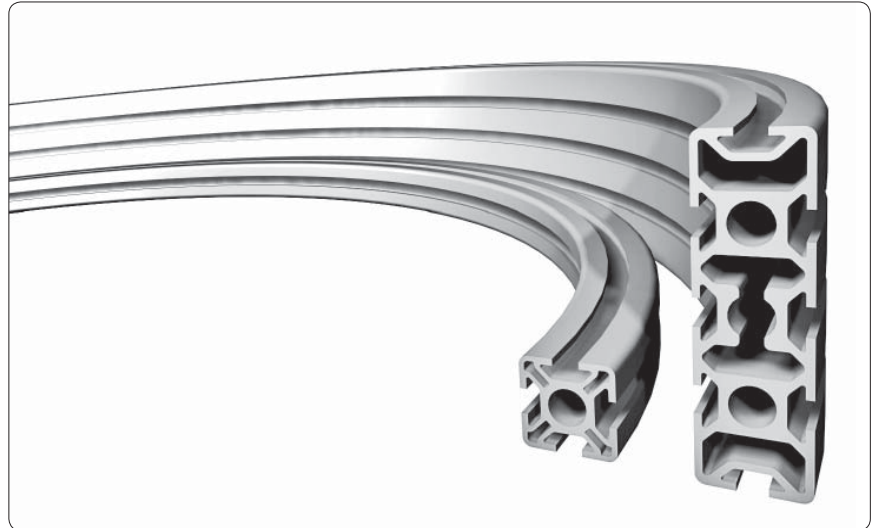

Function 'T- Nut'													Function 'threaded plate'													Function 'connector'																	
position of slot(s)													position of slot(s)													position of slot(s)						position of core hole(s)											
A	B	C	D	E	F	G	H	I	K	L	M	A	B	C	D	E	F	G	H	I	K	L	M	A	B	C	D	E	F	G	H	I	K	L	M	a	b	c	d	e	f	g	h

The marking of the slots and core holes takes place in accordance with the marking for 'the profile machining' ↗ 1.1A

Article-No.	PG	Profile	min. inside-Ø
1.09.016040.14LP	16	16×40, 1E, LP	400
1.09.016040.14SP		16×40, 1E, SP	400
1.10.016040.14LP		16×40, 1F, LP	400
1.10.020020.21SP	20	20×20, 2H, soft, SP	700
1.10.020020.22SP		20×20, 2H, cor., SP	700
1.10.020020.23LP		20×20, 2H, LP	700
1.10.020020.33SP		20×20, 3H, SP	700
1.10.020020.43LP		20×20, 4H, LP	700
1.10.020020.43SP		20×20, 4H, SP	700
1.11.020010.14LP		20×10, 1F, LP	400
1.11.020030.14LP		20×30, 1F, LP	700
1.11.020030.14SBP		20×30, 1F, SP	700
1.11.020030.24LP		20×30, 2F, LP	700
1.11.020030.24SP		20×30, 2F, SP	700
1.11.030030.03SP	30	30×30, 0F, SP	700
1.11.030030.13LP		30×30, 1F, LP	700
1.11.030030.13SP		30×30, 1F, SP	700
1.11.030030.22S		30×30, 2F, cor., S	700
1.11.030030.22SP		30×30, 2F, cor., SP	700
1.11.030030.22SB		30×30, 2F, cor., SB	700
1.11.030030.22SBP		30×30, 2F, cor., SBP	700
1.11.030030.22L		30×30, 2F, cor., L	700
1.11.030030.22LP		30×30, 2F, cor., LP	700
1.11.030030.23L		30×30, 2F, L	700
1.11.030030.23LP		30×30, 2F, LP	700
1.11.030030.23SP		30×30, 2F, SP	700
1.11.030030.33L		30×30, 3F, L	700
1.11.030030.33LP		30×30, 3F, LP	700
1.11.030030.33S		30×30, 3F, S	700
1.11.030030.33SP		30×30, 3F, SP	700
1.11.030030.43L		30×30, 4F, L	700
1.11.030030.43LP		30×30, 4F, LP	700
1.11.030030.43S		30×30, 4F, S	700
1.11.030030.43SP		30×30, 4F, SP	700
1.11.030050.44L		30×50, 4F, L	700
1.11.030050.44LP		30×50, 4F, LP	700
1.11.030050.44S		30×50, 4F, S	700

Article-No.	PG	Profile	min. inside-Ø
1.11.030050.44SP	30	30×50, 4F, SP	700
1.11.030060.04SP		30×60, 0F, SP	700
1.11.030060.64L		30×60, 6F, L	700
1.11.030060.64LP		30×60, 6F, LP	700
1.11.030060.65S		30×60, 6F, S	700
1.11.030060.65SP		30×60, 6F, SP	700
1.11.030100.34SP		30×100, 3F, SP	700
1.11.030100.84SP		30×100, 8F, SP	700
1.11.030100.104SP		30×100, 10F, SP	700
1.11.040040.03SP	40	40×40, 0E, LP	700
1.11.040040.13LP		40×40, 1E, LP	700
1.11.040040.22L		40×40, 2E, cor., L	700
1.11.040040.22LP		40×40, 2E, cor., LP	700
1.11.040040.22S		40×40, 2E, cor., S	700
1.11.040040.22SP		40×40, 2E, cor., SP	700
1.11.040040.23L		40×40, 2E, L	700
1.11.040040.23LP		40×40, 2E, LP	700
1.11.040040.33L		40×40, 3E, L	700
1.11.040040.33LP		40×40, 3E, LP	700
1.11.040040.33S		40×40, 3E, S	700
1.11.040040.33SP		40×40, 3E, SP	700
1.11.040040.43L		40×40, 4E, L	700
1.11.040040.43LP		40×40, 4E, LP	700
1.11.040040.43S		40×40, 4E, S	700
1.11.040040.43SP		40×40, 4E, SP	700
1.11.040080.04LP		40×80, 0E, LP	700
1.11.040080.44L		40×80, 4E, L	700
1.11.040080.64L		40×80, 6E, L	700
1.11.040080.64S		40×80, 6E, S	700
1.11.040080.32LP		40×80, 3E, cor., LP	700
1.11.040080.44LP		40×80, 4E, LP	700
1.11.040080.44LBP		40×80, 4E, LBP	700
1.11.040080.54LP		40×80, 5E, LP	700
1.11.040080.64LP		40×80, 6E, LP	700
1.11.040080.64SP		40×80, 6E, SP	700
1.11.048R00.10SP		48, round, 1E, SP	1.500
1.11.048R00.20SP		48, round, 2E, SP	1.500
1.11.048R00.22SP		48, round, 2E, cor., SP	1.500



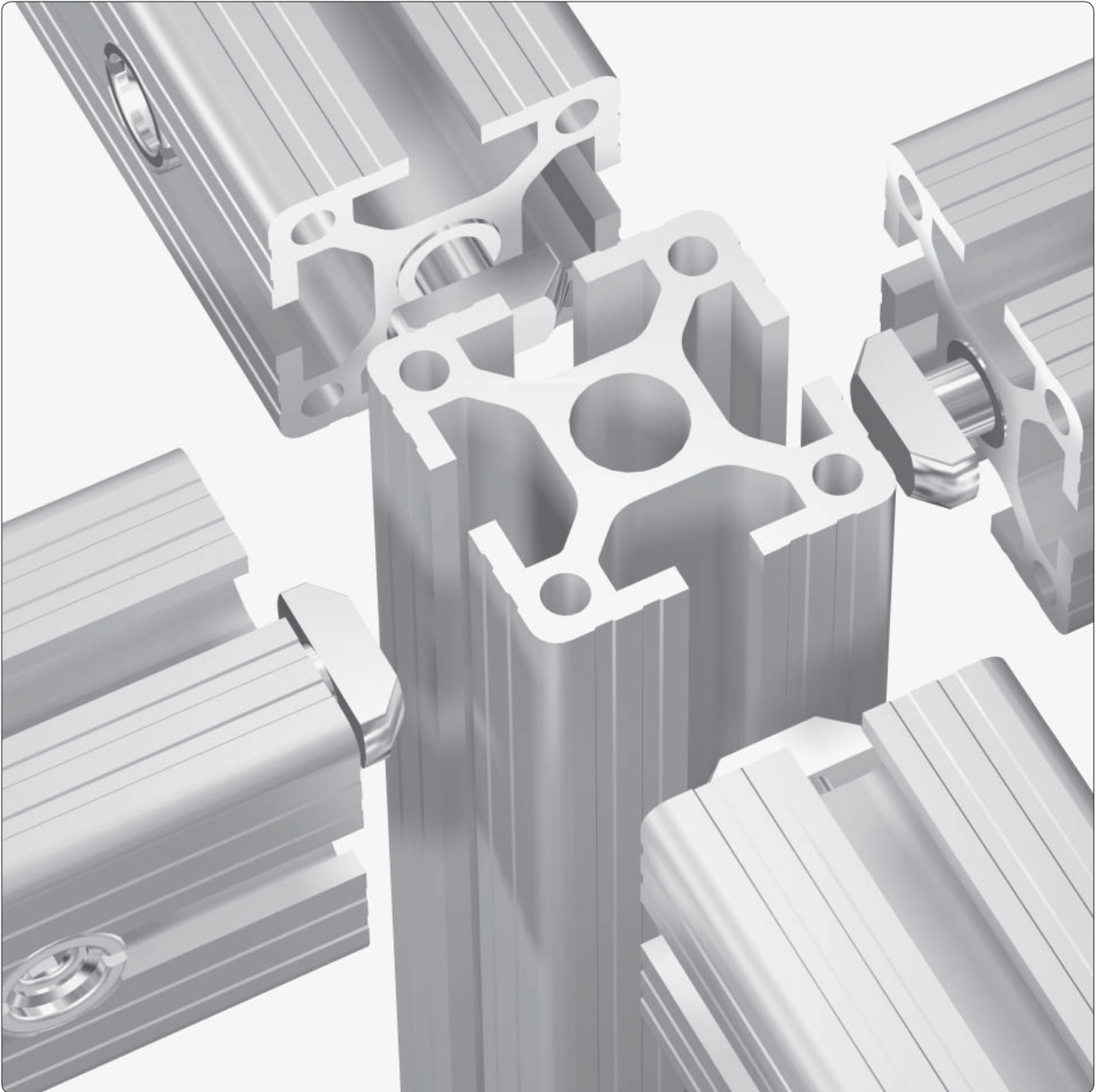

**extremely strong**

**efficient**

**functional**

**The proven connection system!**

The MayTec quick-connection system allows combination of all MayTec profiles in any way imaginable.

It carries same stability out after all four sides.

**The connection allows:**

- easy machining
- quick assembly
- innumerable (dis)assemblies

**The connection system is:**

- complete
- stable
- functional

**Vibration proof**

The different direction angles of lead of thread and clamping cone prevent the loosening of the connection by vibration.

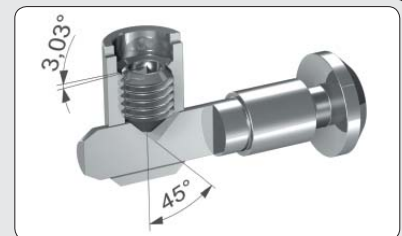



**Stability S-Class**

**MayTec  
Universal-Connector**

**18,000 N**  
working load

**Vibration  
proof**



MayTec connector with square head

The MayTec connector with square head offers the highest load bearing capacity.

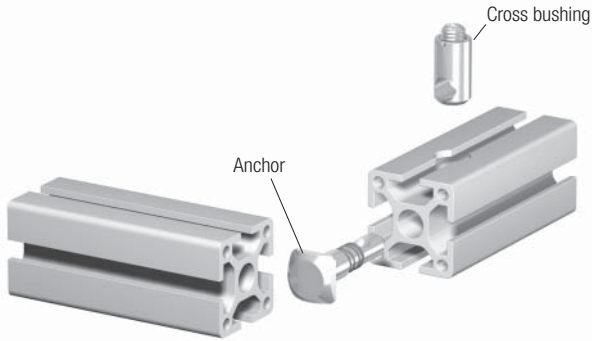

MayTec universal-connector

The MayTec universal-connector allows:

- any desired position of profiles
- only one type for 0° and 90° position of cross bushing
- simple determination of the connector type
- minimisation of stock keeping

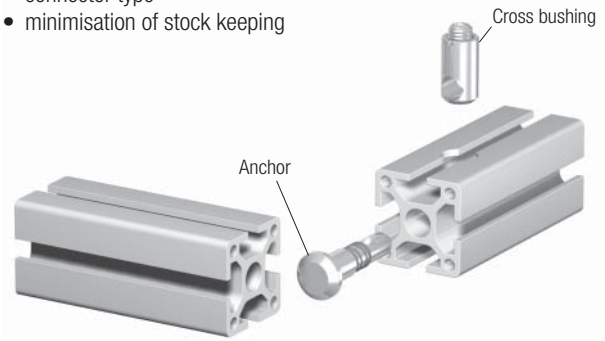

MayTec standard-connector

The MayTec standard-connector allows subsequent front-sided mounting or dismounting in any location.

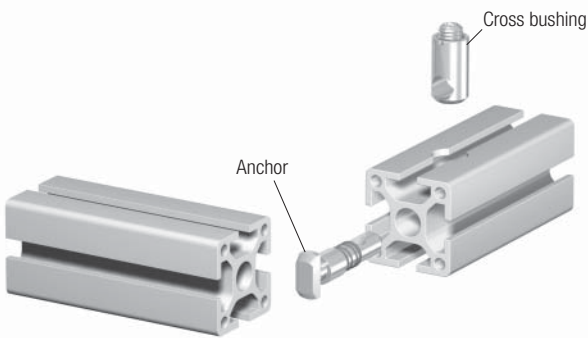

MayTec ground-connector for potential equalisation

The MayTec ground-connector allows potential equalisation between two profiles. When the connector is tightened, the serration at the rear of the anchor head penetrates the anodised profile coating and thus provides an electrical contact.

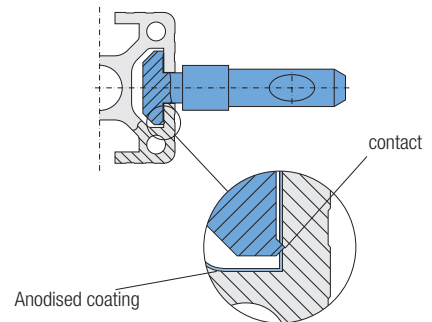

Deliverable types ↗ Connectors 1.2A  
Ground connections ↗ 1.70

MayTec screw-type connector

The MayTec screw-type connector allows connection to profiles by means of T-Nuts.

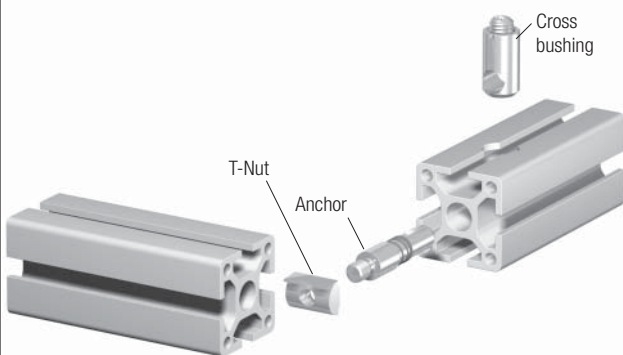

MayTec screw-type connector

The MayTec screw-type connector allows connection to threaded holes in plates.

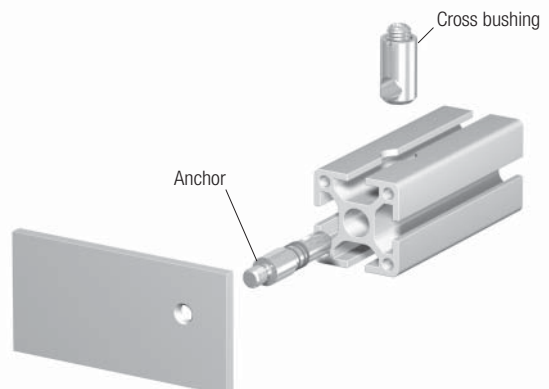



**The MayTec Connector System**

- mounting of connector in core hole
- with machining

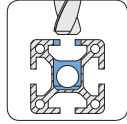

Cross  
bushing bore

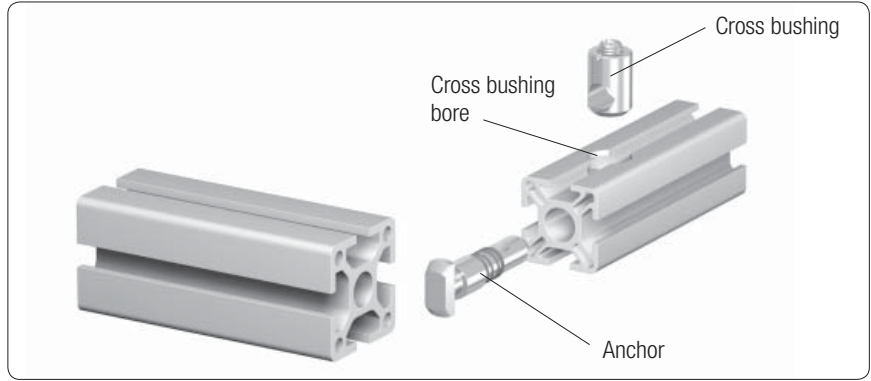

Standard ↗ 96

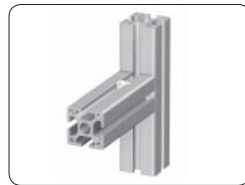

Screw-type ↗ 95, 100

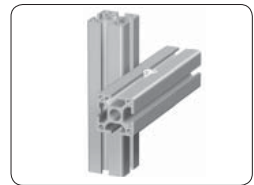

Parallel ↗ 94, 98



Oblique ↗ 94, 96

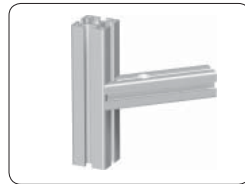

Oblique-cross ↗ 97



Extension / Parallel ↗ 111



Miter ↗ 94, 99



Shifter ↗ 99



Extension ↗ 94, 98

**Anti-twist devices**

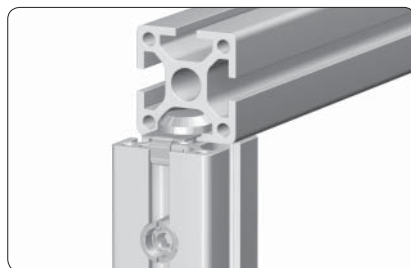

with retaining plate ↗ 133



with T-Nut ↗ 145-148

**Clamping lever for connectors**



Clamping lever ↗ 136

**The MayTec Connector System**

- mounting of connector in slot
- with machining

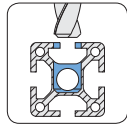

Cross bushing bore

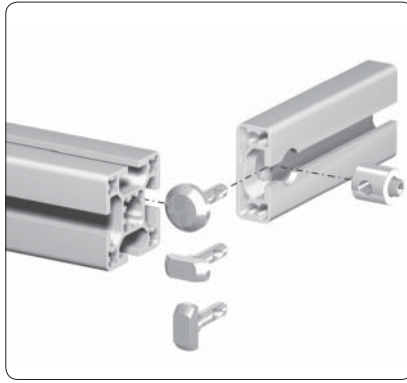

SE-Connector ↗ 113

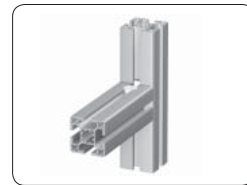
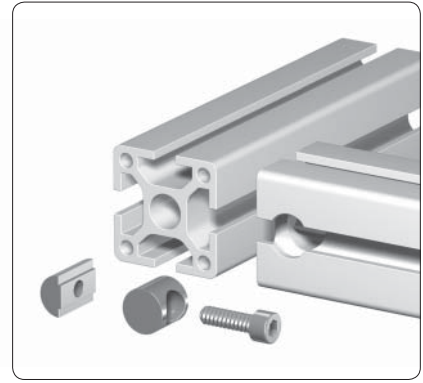

ST-Connector ↗ 114-115

**Screw-type connections**

- with machining

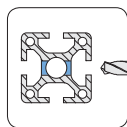
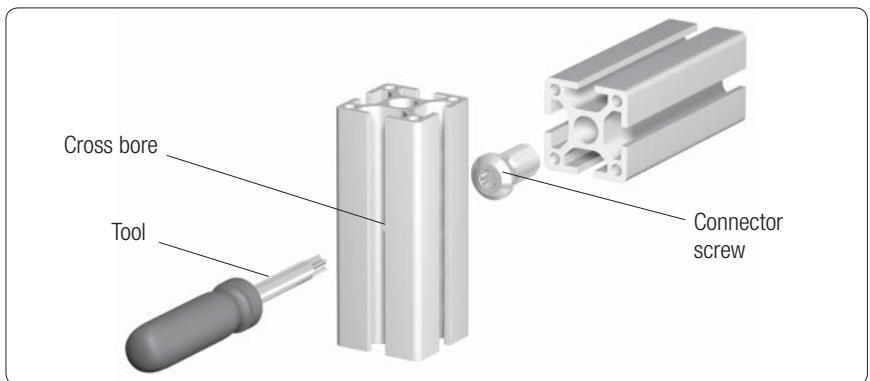

Cross bore

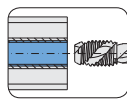

Thread

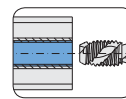

Thread

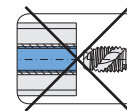

Thread

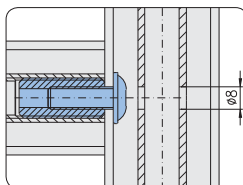

Threaded insert with lens head screw

↗ 1.35

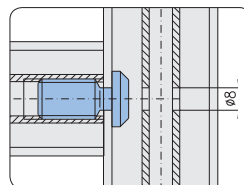

Connector screw

↗ 101

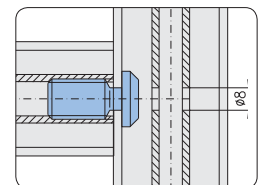

Connector screw, self-cutting

↗ 101, 116

**Insertion connections**

- without machining

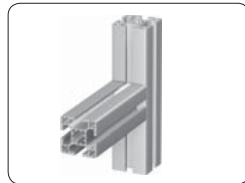
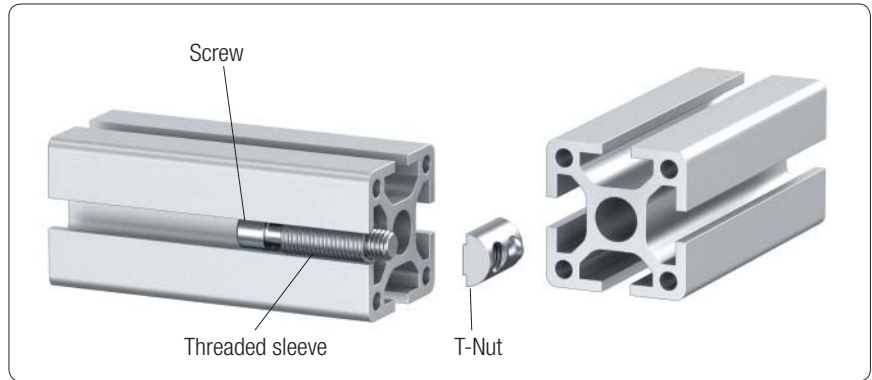

Insertion connector ↗ 119-121

**Cross connections**

- without machining

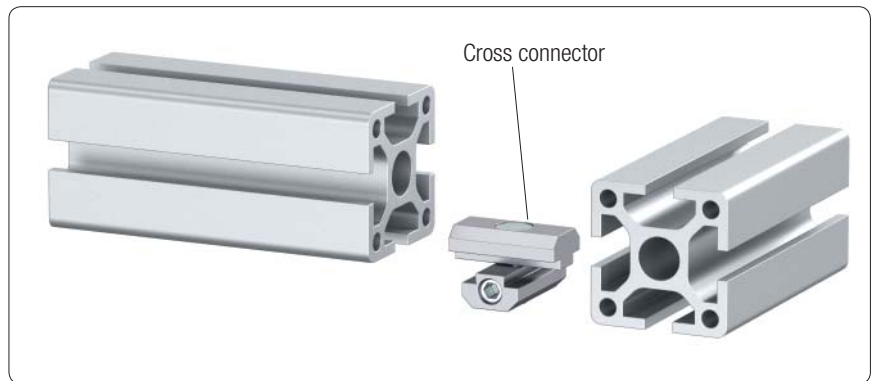

Cross connector ↗ 117

**Parallel connections**

- without machining

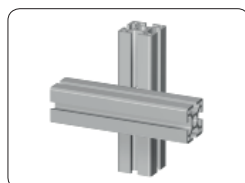
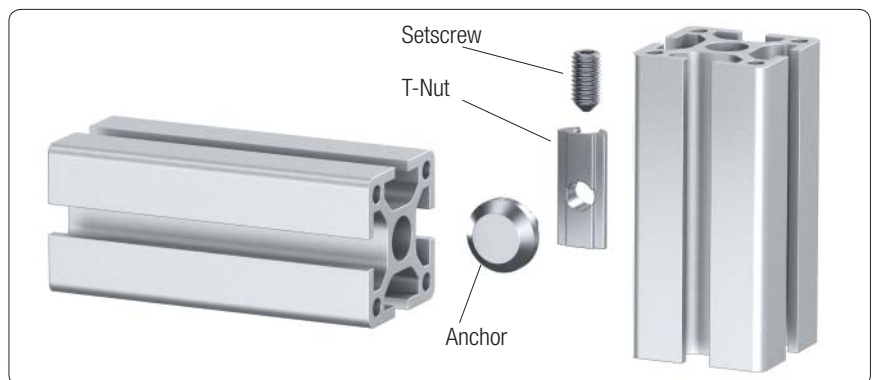

Parallel connector ↗ 118

Angle connections  
• without machining



Angle PA ↗ 1.46

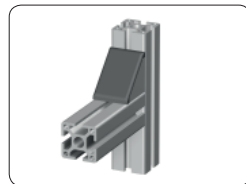

Angle GD-Zn, GD-Al  
↗ 1.46

Manufacture a connection



**Example**

Connection of two profiles 40×40 with one standard connector

**1. Connector selection**

➤ 1.2, Connector selection

**2. Profile machining**

➤ 1.1A, Profile machining

➤ 1.99, Tools

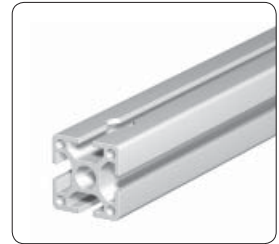
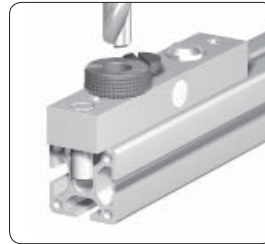
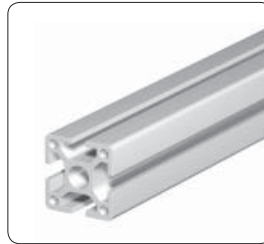

Manufacture the cross bushing bore with the aid of a drill jig

**3. Pre-assembly of the connector**

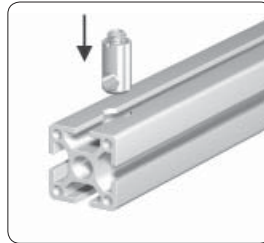

Insert the cross bushing

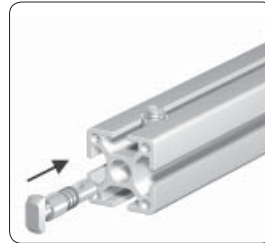

Push in the anchor

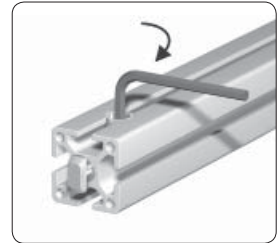

Pretension the anchor

**⚠ Mounting position**

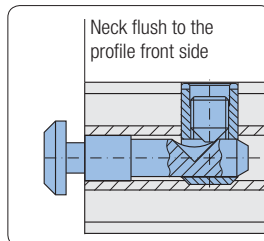

**Comments**

For the optimal assembly of the profiles the connector is to be installed in such a way that the neck is flush to the profile front side

**4. Final assembly**

➤ 1.2F, Torque tightening values for connector setscrew

①

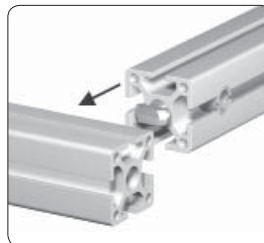

Push in sideways

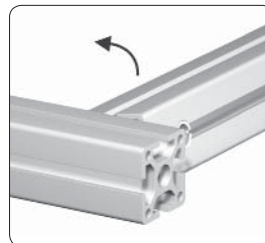

Turn the profile

or

②

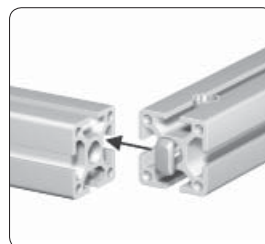

Push in front sided

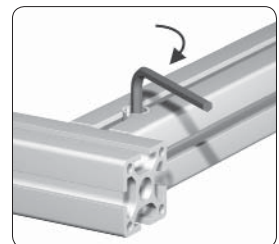

Tighten the setscrew

Connector selection		
Procedure		Example
① <b>Connection</b>	Selection of connector-variant	Standard
② <b>Profile 1</b>	Size of the profile in which the connector should be built into	30×30 mm
③ <b>Core hole</b>	Determination of the core hole Ø	Ø12 mm
④ <b>Profile 2</b>	Determination of the connector-head according to slot-variant of the profile on which it will be joined	40×40 mm / E-slot
⑤ <b>Connector</b>	Determination of connector	<b>1.21.3E1</b>
⑥ <b>Number of degrees</b>	Bent anchor: determine the angle (0° - 45°)	

Connector types and materials		
Connector	Article-No.	Technical data
Standard	1.21.2E0	material: steel strength: ≥ 650 N/mm <sup>2</sup> surface: galvanised
Standard, ground	1.21.2E0 E	
Standard VA	1.21.2E0 V	material: stainless steel 1.4305 strength: 490-685 N/mm <sup>2</sup> surface: pickled and passivated

Special cases				
Profile	Mounting position	PG for connector selection	Mounting position	PG for connector selection
20×30 30×50		20 30		30 50
30×100		30		50

MayTec®		Connectors for profiles with core hole-Ø 12 mm			1.2A								
Connection / Connector	Finished dimension	PG	Article-No. for connector with										
			H-head		F-head		E-head						
			steel standard	E	VA	steel standard	E	VA	steel standard	E	VA		
Universal 		20	1.21.2H0			1.21.2F0	E	V	1.21.2E0	E	V		
		30	1.21.3H0			1.21.3F0	E	V	1.21.3E0	E	V		
		40	1.21.40H0			1.21.4F0	E	V	1.21.4E0	E	V		
		45	1.21.45H0			1.21.45F0	E	V	1.21.45E0	E	V		
		50	1.21.50H0			1.21.5F0	E	V	1.21.5E0	E	V		
		60	1.21.60H0			1.21.6F0	E	V	1.21.6E0	E	V		
Standard 		20				1.21.2F1	E	V	1.21.2E1	E	V		
		30				1.21.3F1	E	V	<b>1.21.3E1</b>	E	V		
		40				1.21.4F1	E	V	1.21.4E1	E	V		
		45				1.21.45F1	E	V	1.21.45E1	E	V		
		50				1.21.5F1	E	V	1.21.5E1	E	V		
		60				1.21.6F1	E	V	1.21.6E1	E	V		
90° 		20				1.21.2F2	E	V	1.21.2E2	E	V		
		30				1.21.3F2	E	V	1.21.3E2	E	V		
		40				1.21.4F2	E	V	1.21.4E2	E	V		
		45				1.21.45F2	E	V	1.21.45E2	E	V		
		50				1.21.5F2	E	V	1.21.5E2	E	V		
		60				1.21.6F2	E	V	1.21.6E2	E	V		
Square head Universal 		20							1.21.20E40				
		30							1.21.30E40				
		40							1.21.40E40				
		45							1.21.45E40				
		50							1.21.50E40				
		60							1.21.60E40				
Square head Standard 		20				1.21.20F41							
		30					1.21.30F41						

Connection / Connector	Finished dimension	PG	Article-No. for connector with										
			H-head		F-head				E-head				
			steel standard	E	VA	steel standard	E	VA	steel standard	E	VA		
Universal 		20	1.20.2H0		V	1.20.2F0			1.20.2E0				
Oblique -hinge l + r 		20	1.20.2HK1			1.20.2FK1							
Oblique 90° -hinge 		20	1.20.2HK2			1.20.2FK2							
Parallel -square 		20	1.20.2H0		V	1.20.2F0			1.20.2E0				
-cross 													
-high 													

Connection / Connector	Finished dimension	PG	Article-No. for connector		
			steel standard	E	VA
Miter -hinge l + r 		20	1.20.2G1		
Miter 90° -hinge l + r 		20	1.20.2G2		
Extension 		20	1.20.2V0		V

Machining of profiles with core hole-Ø 6 mm for miter

In order not to reduce the strength of the miter joint one profile end must be counterbored

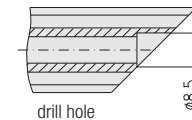

The center portion of the anchor part is to be located in the counterbored profile section

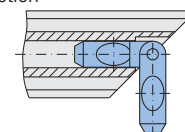

**Comments**



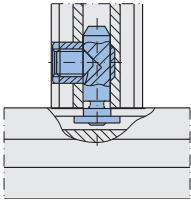
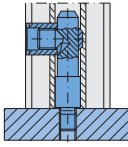
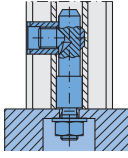



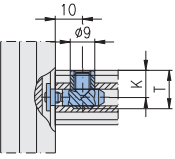
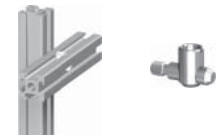
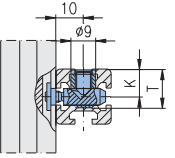
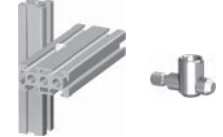
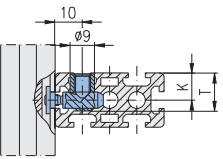
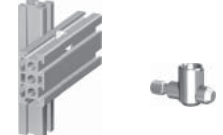
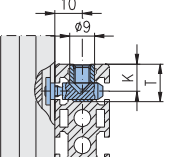

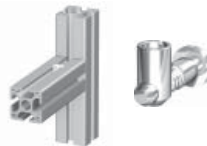
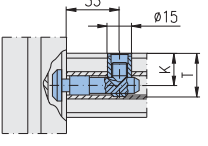
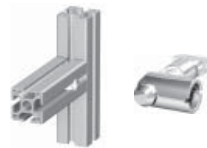
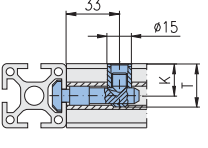
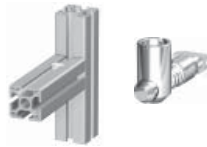
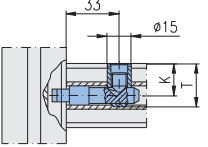

Use drill for miter anchor Article-No.: 1.99.0310800 ↗ tools 1.99

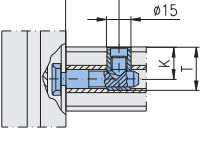

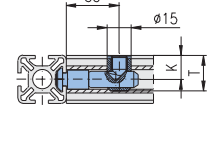

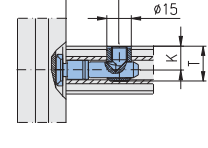

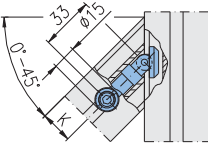

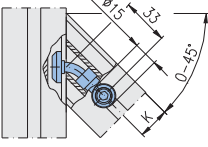

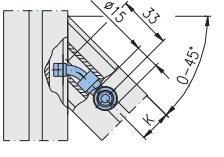

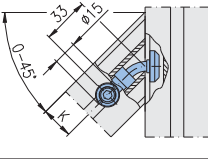
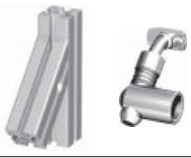
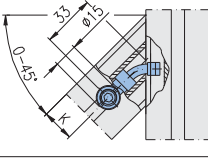
Connection variants with screw-type connectors		
		
Profile with profile	Profile to plate with thread	Profile to plate with through-hole

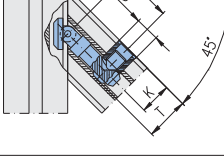
Mounting instruction for screw-type connectors
<ol style="list-style-type: none"> <li>1. Screw anchor in until it stops against the shoulder</li> <li>2. Unscrew anchor until it lines-up with the cross bushing position (max. one turn)</li> <li>3. Set up profile with cross bushing</li> </ol>

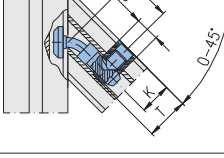

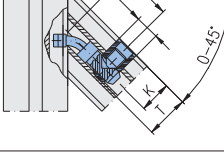
Connection / Connector	Finished dimension	PG	thread	Article-No. for connector	
				steel standard	VA E
Screw-type front sided 		20	M4×7	1.20.2S2M4/7	V
			M5×7	1.20.2S2M5/7	
			M6×7	1.20.2S2M6/7	
Screw-type parallel -square 					
-cross 					
-high 					

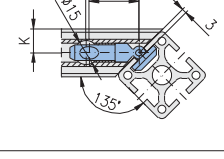

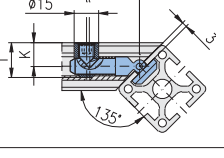

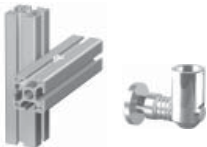
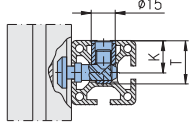
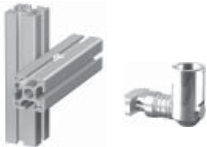
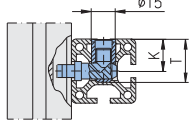
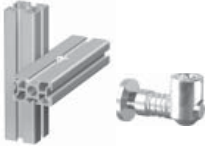
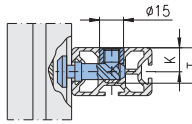
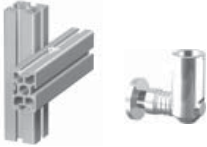
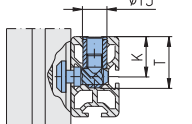
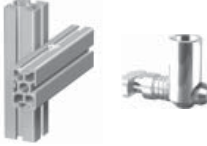
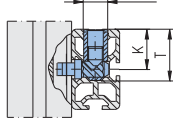

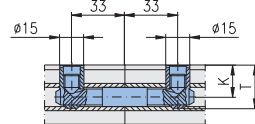

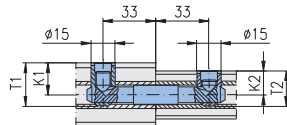

Connection / Connector	Finished dimension	PG	Article-No. for connector with								
			H-head		F-head				E-head		
			steel standard	E	VA	steel standard	E	VA	steel standard	E	VA
Universal 		20	1.21.2H0			1.21.2F0	E	V	1.21.2E0	E	V
		30	1.21.3H0			1.21.3F0	E	V	1.21.3E0	E	V
		40	1.21.40H0			1.21.4F0	E	V	1.21.4E0	E	V
		45	1.21.45H0			1.21.45F0	E	V	1.21.45E0	E	V
		50	1.21.50H0			1.21.5F0	E	V	1.21.5E0	E	V
		60	1.21.60H0			1.21.6F0	E	V	1.21.6E0	E	V
Standard 		20				1.21.2F1	E	V	1.21.2E1	E	V
		30				1.21.3F1	E	V	1.21.3E1	E	V
		40				1.21.4F1	E	V	1.21.4E1	E	V
		45				1.21.45F1	E	V	1.21.45E1	E	V
		50				1.21.5F1	E	V	1.21.5E1	E	V
		60				1.21.6F1	E	V	1.21.6E1	E	V
90° 		20				1.21.2F2	E	V	1.21.2E2	E	V
		30				1.21.3F2	E	V	1.21.3E2	E	V
		40				1.21.4F2	E	V	1.21.4E2	E	V
		45				1.21.45F2	E	V	1.21.45E2	E	V
		50				1.21.5F2	E	V	1.21.5E2	E	V
		60				1.21.6F2	E	V	1.21.6E2	E	V
Square head Universal 		20							1.21.20E40		
		30							1.21.30E40		
		40							1.21.40E40		
		45							1.21.45E40		
		50							1.21.50E40		
		60							1.21.60E40		
Square head Standard 		20				1.21.20F41					
		30				1.21.30F41					
		40				1.21.40F41					
		45				1.21.45F41					
		50				1.21.50F41					
		60				1.21.60F41					
90° 		20				1.21.20F42					
		30				1.21.30F42					
		40				1.21.40F42					
		45				1.21.45F42					
		50				1.21.50F42					
		60				1.21.60F42					
Oblique -hinge l + r 		20				1.21.2FK1		V	1.21.2EK1		V
		30				1.21.3FK1		V	1.21.3EK1		V
		40				1.21.4FK1		V	1.21.4EK1		V
		45				1.21.45FK1		V	1.21.45EK1		V
		50				1.21.5FK1		V	1.21.5EK1		V
		60				1.21.6FK1		V	1.21.6EK1		V
-bent anchor l 		20				1.21.2FB1L/□□	E		1.21.2EB1L/□□	E	
		30				1.21.3FB1L/□□	E		1.21.3EB1L/□□	E	
		40				1.21.4FB1L/□□	E		1.21.4EB1L/□□	E	
		45				1.21.45FB1L/□□	E		1.21.45EB1L/□□	E	
		50				1.21.5FB1L/□□	E		1.21.5EB1L/□□	E	
		60				1.21.6FB1L/□□	E		1.21.6EB1L/□□	E	

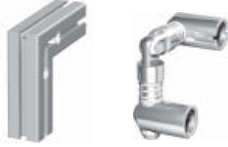
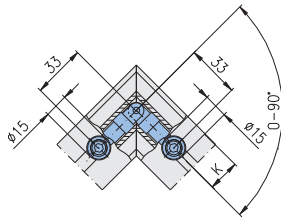
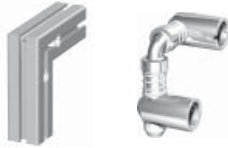
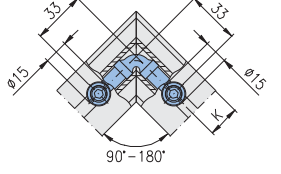
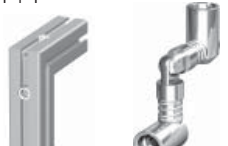
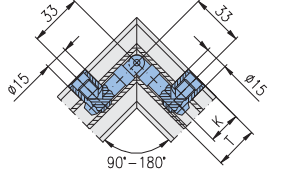
Connection / Connector	Finished dimension	PG	Article-No. for connector with											
			H-head		F-head				E-head					
			steel standard	E	steel standard	VA	steel standard	E	VA	steel standard	E	VA		
Oblique -bent anchor standard l  		20					1.21.2F1B1L/□□			1.21.2E1B1L/□□				
		30					1.21.3F1B1L/□□			1.21.3E1B1L/□□				
		40					1.21.4F1B1L/□□			1.21.4E1B1L/□□				
		45					1.21.45F1B1L/□□			1.21.45E1B1L/□□				
		50					1.21.5F1B1L/□□			1.21.5E1B1L/□□				
		60					1.21.6F1B1L/□□			1.21.6E1B1L/□□				
-bent anchor r  		20						1.21.2FB1R/□□	E	1.21.2EB1R/□□	E			
		30							1.21.3FB1R/□□	E	1.21.3EB1R/□□	E		
		40								1.21.4FB1R/□□	E	1.21.4EB1R/□□	E	
		45								1.21.45FB1R/□□	E	1.21.45EB1R/□□	E	
		50								1.21.5FB1R/□□	E	1.21.5EB1R/□□	E	
		60								1.21.6FB1R/□□	E	1.21.6EB1R/□□	E	
-bent anchor standard r  		20						1.21.2F1B1R/□□		1.21.2E1B1R/□□				
		30							1.21.3F1B1R/□□		1.21.3E1B1R/□□			
		40								1.21.4F1B1R/□□		1.21.4E1B1R/□□		
		45								1.21.45F1B1R/□□		1.21.45E1B1R/□□		
		50								1.21.5F1B1R/□□		1.21.5E1B1R/□□		
		60								1.21.6F1B1R/□□		1.21.6E1B1R/□□		
Oblique 90° -hinge  		20						1.21.2FK2		V	1.21.2EK2	V		
		30							1.21.3FK2		V	1.21.3EK2	V	
		40								1.21.4FK2		V	1.21.4EK2	V
		45								1.21.45FK2		V	1.21.45EK2	V
		50								1.21.5FK2		V	1.21.5EK2	V
		60								1.21.6FK2		V	1.21.6EK2	V
-bent anchor  		20						1.21.2FB2/□□	E	1.21.2EB2/□□	E			
		30							1.21.3FB2/□□	E	1.21.3EB2/□□	E		
		40								1.21.4FB2/□□	E	1.21.4EB2/□□	E	
		45								1.21.45FB2/□□	E	1.21.45EB2/□□	E	
		50								1.21.5FB2/□□	E	1.21.5EB2/□□	E	
		60								1.21.6FB2/□□	E	1.21.6EB2/□□	E	
-bent anchor 90°  		20						1.21.2F2B2/□□		1.21.2E2B2/□□				
		30							1.21.3F2B2/□□		1.21.3E2B2/□□			
		40								1.21.4F2B2/□□		1.21.4E2B2/□□		
		45								1.21.45F2B2/□□		1.21.45E2B2/□□		
		50								1.21.5F2B2/□□		1.21.5E2B2/□□		
		60								1.21.6F2B2/□□		1.21.6E2B2/□□		
Oblique-cross-hinge  		20						1.21.2FK3			1.21.2EK3	V		
		30							1.21.3FK3			1.21.3EK3	V	
		40								1.21.4FK3			1.21.4EK3	V
		45								1.21.45FK3			1.21.45EK3	V
		50								1.21.5FK3			1.21.5EK3	V
		60								1.21.6FK3			1.21.6EK3	V
90°  		20						1.21.2FK4			1.21.2EK4	V		
		30							1.21.3FK4			1.21.3EK4	V	
		40								1.21.4FK4			1.21.4EK4	V
		45								1.21.45FK4			1.21.45EK4	V
		50								1.21.5FK4			1.21.5EK4	V
		60								1.21.6FK4			1.21.6EK4	V

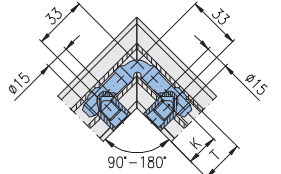
Connection / Connector	Finished dimension	PG	Article-No. for connector with								
			H-head		F-head				E-head		
			steel standard	E	steel standard	E	VA	steel standard	E	VA	
Parallel -square 		20									
		30									
		40			1.21.3F5				1.21.3E5		
		45			1.21.4F5				1.21.4E5		
		50			1.21.45F5				1.21.45E5		
		60			1.21.5F5				1.21.5E5		
-square 90° 		20									
		30									
		40									
		45									
		50									
		60									
-cross 		20									
		30			1.21.2/3F5				1.21.2/3E5		
		40			1.21.3/5F5				1.21.3/5E5		
		45									
		50									
		60									
-high 		20									
		30									
		40			1.21.3/2F5				1.21.3/2E5		
		45									
		50			1.21.5/3F5				1.21.5/3E5		
		60									
-high 90° 		20									
		30									
		40									
		45									
		50									
		60									

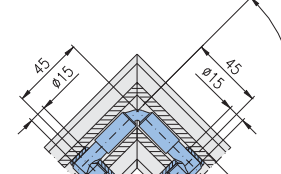
Connection / Connector	Finished dimension	PG, K×2	Article-No. for connector			PG, K×2	Article-No. for connector		
			steel standard	E	VA		steel standard	E	VA
Extension 		20	1.21.2V0		V				
		30	1.21.3V0		V				
		40	1.21.4V0		V				
		45	1.21.45V0		V				
		50	1.21.5V0		V				
		60	1.21.6V0		V				
		30/20	1.21.3/2V0		V	50/20	1.21.5/2V0		V
		40/20	1.21.4/2V0		V	30	1.21.5/3V0		V
		30	1.21.4/3V0		V	40	1.21.5/4V0		V
		45/20	1.21.45/2V0		V	45	1.21.5/45V0		V
		30	1.21.45/3V0		V	60/20	1.21.6/2V0		V
		40	1.21.45/4V0		V	30	1.21.6/3V0		V
						40	1.21.6/4V0		V
						45	1.21.6/45V0		V
						50	1.21.6/5V0		V

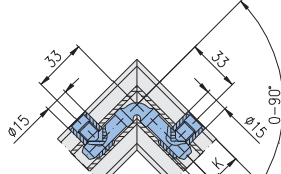
E = ground-connector, VA = stainless steel 1.4305

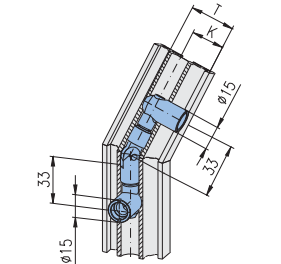
Connection / Connector	Finished dimension	PG	Article-No. for connector			
			steel standard	E	VA	
Miter -hinge l + r  		20	1.21.2G1		V	
		30	1.21.3G1		V	
		40	1.21.4G1		V	
		45	1.21.45G1		V	
		50	1.21.5G1		V	
		60	1.21.6G1		V	
-bent anchor l + r  		20	1.21.2GB1/□□			
		30	1.21.3GB1/□□			
		40	1.21.4GB1/□□			
		45	1.21.45GB1/□□			
		50	1.21.5GB1/□□			
		60	1.21.6GB1/□□			
Miter 90° -hinge l + r  		20	1.21.2G2		V	
		30	1.21.3G2		V	
		40	1.21.4G2		V	
		45	1.21.45G2		V	
		50	1.21.5G2		V	
		60	1.21.6G2		V	
-bent anchor l  		20	1.21.2GB2L/□□			
		30	1.21.3GB2L/□□			
		40	1.21.4GB2L/□□			
		45	1.21.45GB2L/□□			
		50				
		60				
			20			
			30			
			40			
			45			
			50	1.21.5GB2L/□□		
			60	1.21.6GB2L/□□		
-bent anchor r  		20	1.21.2GB2R/□□			
		30	1.21.3GB2R/□□			
		40	1.21.4GB2R/□□			
		45	1.21.45GB2R/□□			
		50	1.21.5GB2R/□□			
		60	1.21.6GB2R/□□			
Shifter  		20	1.21.2GS			
		30	1.21.3GS			
		40	1.21.4GS			
		45	1.21.45GS			
		50	1.21.5GS			
		60	1.21.6GS			

## Connection variants with screw-type connectors

Profile with profile	Profile to plate with thread	Profile to plate with through-hole



## Mounting instruction for screw-type connectors



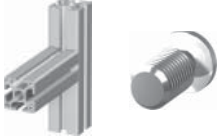
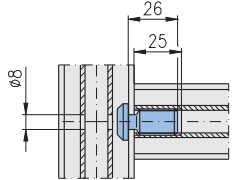
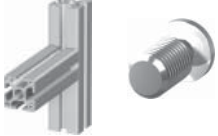
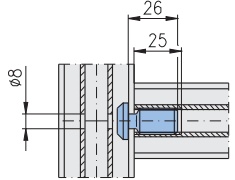

1. Screw anchor in until it stops against the shoulder
2. Unscrew anchor until it lines-up with the cross bushing position (max. one turn)
3. Set up profile with cross bushing

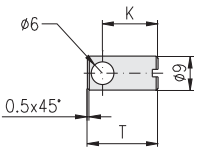
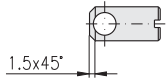
Connection / Connector	Finished dimension	PG	thread	Article-No. for connectors for mounting on profiles with								
				F-slot		E-slot		other				
				Length of thread		Length of thread		Length of thread				
7 mm	11 mm	40 mm	steel standard	E	VA	steel standard	E	VA	steel standard	E	VA	
Screw-type - front sided 		20	M6				1.21.2S1M6/11					
							1.21.3S1M6/11					
							1.21.4S1M6/11					
							1.21.45S1M6/11					
							1.21.5S1M6/11					
							1.21.6S1M6/11					
		20	M8	1.21.20S1M8/7			1.21.2S1M8/11	V		1.21.2S1M8/40		
				1.21.30S1M8/7			1.21.3S1M8/11	V		1.21.3S1M8/40		
				1.21.40S1M8/7			1.21.4S1M8/11	V		1.21.4S1M8/40		
				1.21.45S1M8/7			1.21.45S1M8/11	V		1.21.45S1M8/40		
				1.21.50S1M8/7			1.21.5S1M8/11	V		1.21.5S1M8/40		
				1.21.60S1M8/7			1.21.6S1M8/11	V		1.21.6S1M8/40		
Screw-type - parallel -square 		20	M8				1.21.2S5M8/11					
							1.21.3S5M8/7			1.21.3S5M8/11		
							1.21.4S5M8/7			1.21.4S5M8/11		
										1.21.45S5M8/11		
										1.21.5S5M8/11		
										1.21.6S5M8/11		
-cross 		20	M8				1.21.2/3S5M8/11					
							1.21.3/5S5M8/11					
-high 		20	M8									
							1.21.3/2S5M8/11					
							1.21.5/3S5M8/11					

Connection / Connector	Finished dimension	Article-No. for connector with								
		H-head		F-head		E-head				
		steel standard	E	VA	steel standard	E	VA	steel standard	E	VA
Connector screw 					1.21.VSFM14			1.21.VSEM14		
-self-cutting 					1.21.VSFS126S			1.21.VSES126S		
					1.21.VSFS128L			1.21.VSES128L		

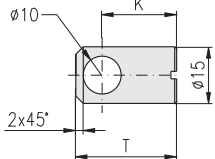
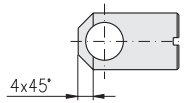
Slot type	Cross bushing	Chamfer	Profile	PG	Core hole distance <b>K</b>	Boring depth, Cross bushing length <b>T</b>	Drill-Ø	Article-No.	
								steel	VA

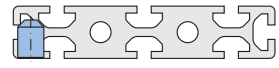
H-slots									
	0.5x45°	Standard	20	10	14	9.2	1.20.B21	V	
	1.5x45°						  1.10.020020.21SP	1.20.B22	

F + E-slots									
	2x45°	Standard	20	10	17	15.25	1.21.B20	V	
				15	22	15.25	1.21.B30	V	
				20	27	15.25	1.21.B40	V	
				20	27	15.25	1.21.B40R		
				22.5	29.5	15.25	1.21.B45	V	
				25	32	15.25	1.21.B50	V	
				30	37	15.25	1.21.B60	V	
				4x45°	  1.11.030030.21S(P)  1.11.030150.84SP	30	15	22	15.25
	 1.11.040040.28LP	40	20	27	15.25	1.21.B44			

tools ↗ 1.99, VA = stainless steel 1.4305

Slot type Connector	Cross bushing	PG/ Profile/ Slot	Core hole distance <b>K</b>	Boring depth, Cross bushing length <b>T</b>	Drill-Ø	Article-No.	
						steel	VA
<b>E-slots</b>							
Special- universal-connector for profile 30×150 ↗ 110		30×150	15	30	15.25	1.21.B31	
Special- SE-Connector ↗ 113		16, E3	-	15	15.25	1.21.BE3	
		E4	-	16	15.25	1.21.BE4	
Special- ST-Connector ↗ 114		E	-	19	15.25	1.21.STBM6	
Special- ST-Connector with screw-type anchor ↗ 115		16, E3	-	40	12.2	1.21.STSB40	

tools ↗ 1.99, VA = stainless steel 1.4305

## Mounting variants

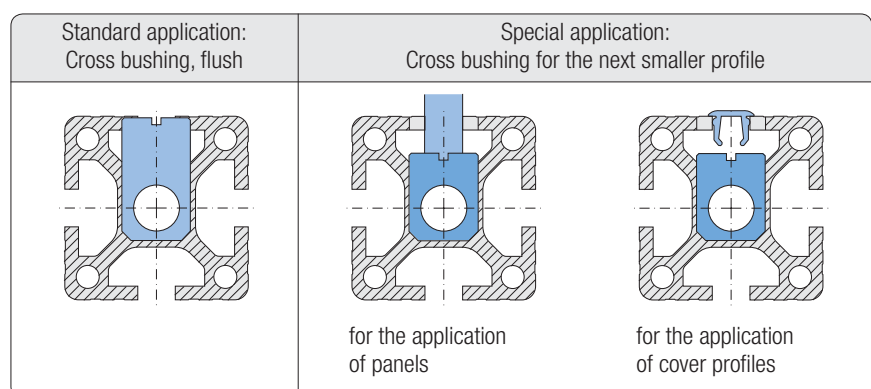





Connector components

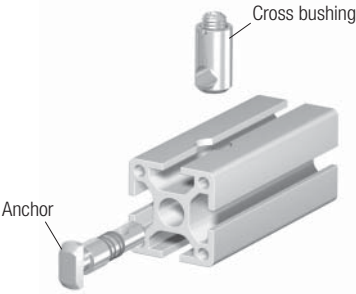

As an alternative to the complete connector it is also possible to order the component parts.  
Because of the extensive combination possibilities, storage of the complete connectors will be reduced by over 80%.

Connector components for profiles with  
core hole-Ø 6 mm → 105  
core hole-Ø 12 mm → 106-109

Connector for core hole-Ø 6 mm			Connector complete			Single parts					
			PG 20			Anchor		Piece			
			steel standard	E	VA	steel standard	E	VA			
		Universal	1.20.2H0		V	1.20.A2H0		V	1	1	
			1.20.2F0			1.20.A2F0			1	1	
			1.20.2E0			1.20.A2E0			1	1	
		Oblique -hinge l + r	1.20.2HK1			1.20.A2HK1			1	1	
			1.20.2FK1			1.20.A2FK1			1	1	
		90° -hinge	1.20.2HK2			1.20.A2HK2			1	1	
			1.20.2FK2			1.20.A2FK2			1	1	
		Parallel -square <sup>1)</sup>	1.20.2H0		V						
			1.20.2F0								
			1.20.2E0								
		-cross <sup>1)</sup>	1.20.2H0		V						
			1.20.2F0								
			1.20.2E0								
		-high <sup>1)</sup>	1.20.2H0		V						
			1.20.2F0								
			1.20.2E0								
		Miter -hinge l + r	1.20.2G1			1.20.A2G1			1	2	
		90° -hinge l + r	1.20.2G2			1.20.A2G2			1	2	
		Extension	1.20.2V0		V	1.20.A2V0		V	1	2	
		Screw-type	1.20.2S2M4/7		V	1.20.A2S2M4/7		V	1	1	
			1.20.2S2M5/7			1.20.A2S2M5/7			1	1	
			1.20.2S2M6/7			1.20.A2S2M6/7			1	1	
		-Parallel-square <sup>2)</sup>	1.20.2S2M4/7		V						
			1.20.2S2M5/7								
			1.20.2S2M6/7								
		-Parallel-cross <sup>2)</sup>	1.20.2S2M4/7		V						
			1.20.2S2M5/7								
			1.20.2S2M6/7								
		-Parallel-high <sup>2)</sup>	1.20.2S2M4/7		V						
			1.20.2S2M5/7								
			1.20.2S2M6/7								













	Cross bushing, steel	1.20.B21		Cross bushing, steel
	Cross bushing, VA	1.20.B21	V	Cross bushing, VA



E = ground-connector, VA = stainless steel 1.4305

<sup>1)</sup> = Connector, universal

<sup>2)</sup> = Connector, screw-type

2



Connector for core hole-Ø 12 mm			Connectors, complete						
			PG 20		PG 30		PG 40		
			steel standard	E VA	steel standard	E VA	steel standard	E VA	
		Universal	1.21.2H0		1.21.3H0		1.21.40H0		
			1.21.2F0	E V	1.21.3F0	E V	1.21.4F0	E V	
			1.21.2E0	E V	1.21.3E0	E V	1.21.4E0	E V	
		Standard	1.21.2F1	E V	1.21.3F1	E V	1.21.4F1	E V	
			1.21.2E1	E V	1.21.3E1	E V	1.21.4E1	E V	
		90°	1.21.2F2	E V	1.21.3F2	E V	1.21.4F2	E V	
			1.21.2E2	E V	1.21.3E2	E V	1.21.4E2	E V	
		Square head Universal	1.21.20E40		1.21.30E40		1.21.40E40		
		Standard	1.21.20F41		1.21.30F41		1.21.40F41		
		90°	1.21.20F42		1.21.30F42		1.21.40F42		
		Oblique -hinge l + r	1.21.2FK1		1.21.3FK1		1.21.4FK1		
			1.21.2EK1		1.21.3EK1		1.21.4EK1		
		-bent anchor l	1.21.2FB1L/□□	E	1.21.3FB1L/□□	E	1.21.4FB1L/□□	E	
			1.21.2EB1L/□□	E	1.21.3EB1L/□□	E	1.21.4EB1L/□□	E	
		-bent a. standard l	1.21.2F1B1L/□□		1.21.3F1B1L/□□		1.21.4F1B1L/□□		
			1.21.2E1B1L/□□		1.21.3E1B1L/□□		1.21.4E1B1L/□□		
		-bent anchor r	1.21.2FB1R/□□	E	1.21.3FB1R/□□	E	1.21.4FB1R/□□	E	
			1.21.2EB1R/□□	E	1.21.3EB1R/□□	E	1.21.4EB1R/□□	E	
		-bent a. standard r	1.21.2F1B1R/□□		1.21.3F1B1R/□□		1.21.4F1B1R/□□		
			1.21.2E1B1R/□□		1.21.3E1B1R/□□		1.21.4E1B1R/□□		
		90°	-hinge	1.21.2FK2		1.21.3FK2		1.21.4FK2	
				1.21.2EK2		1.21.3EK2		1.21.4EK2	
1.21.2FB2/□□	E			1.21.3FB2/□□	E	1.21.4FB2/□□	E		
-bent anchor	1.21.2EB2/□□	E	1.21.3EB2/□□	E	1.21.4EB2/□□	E			
	1.21.2F2B2/□□		1.21.3F2B2/□□		1.21.4F2B2/□□				
	1.21.2E2B2/□□		1.21.3E2B2/□□		1.21.4E2B2/□□				
		Oblique-cross	-hinge		1.21.3FK3		1.21.4FK3		
			1.21.2EK3		1.21.3EK3		1.21.4EK3		
-hinge 90°	1.21.2FK4		1.21.3FK4		1.21.4FK4				
	1.21.2EK4		1.21.3EK4		1.21.4EK4				
		Parallel -square			1.21.3/2F5 <sup>2)</sup>				
					1.21.3/2E5 <sup>2)</sup>				
		1.21.2/3F5 <sup>1)</sup>			1.21.3F5				
			1.21.2/3E5 <sup>1)</sup>		1.21.3E5				
		-square 90°			1.21.3E2-5				
			-cross <sup>1)</sup>				1.21.4F5		
							1.21.4E5		
		-high <sup>2)</sup>			1.21.3/5F5 <sup>1)</sup>				
			1.21.3/5E5 <sup>1)</sup>						
-high 90°									

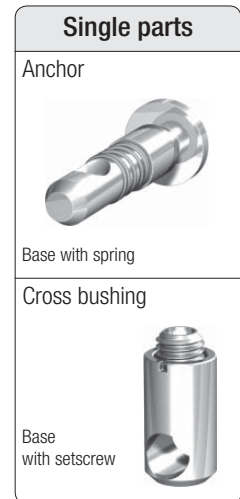

	Cross bushing, steel	1.21.B20		1.21.B30		1.21.B40		
	Cross bushing, VA		1.21.B20	V	1.21.B30	V	1.21.B40	V

E = ground connector, VA = stainless steel 1.4305

PG 45						PG 50						PG 60						Single parts		
steel standard		E	VA	steel standard		E	VA	steel standard		E	VA	Anchor		steel standard		E	VA	Piece		
1.21.45H0				1.21.50H0				1.21.60H0				1.21.A1H0						1 1		
1.21.45F0	E	V		1.21.5F0	E	V		1.21.6F0	E	V		1.21.A1F0	E	V				1 1		
1.21.45E0	E	V		1.21.5E0	E	V		1.21.6E0	E	V		1.21.A1E0	E	V				1 1		
1.21.45F1	E	V		1.21.5F1	E	V		1.21.6F1	E	V		1.21.A1F1	E	V				1 1		
1.21.45E1	E	V		1.21.5E1	E	V		1.21.6E1	E	V		1.21.A1E1	E	V				1 1		
1.21.45F2	E	V		1.21.5F2	E	V		1.21.6F2	E	V		1.21.A1F2	E	V				1 1		
1.21.45E2	E	V		1.21.5E2	E	V		1.21.6E2	E	V		1.21.A1E2	E	V				1 1		
1.21.45E40				1.21.50E40				1.21.60E40				1.21.A1E40						1 1		
1.21.45F41				1.21.50F41				1.21.60F41				1.21.A1F41						1 1		
1.21.45F42				1.21.50F42				1.21.60F42				1.21.A1F42						1 1		
1.21.45FK1		V		1.21.5FK1		V		1.21.6FK1		V		1.21.A1FK1		V				1 1		
1.21.45EK1		V		1.21.5EK1		V		1.21.6EK1		V		1.21.A1EK1		V				1 1		
1.21.45FB1L/□□	E			1.21.5FB1L/□□	E			1.21.6FB1L/□□	E			1.21.A1FB1L/□□	E					1 1		
1.21.45EB1L/□□	E			1.21.5EB1L/□□	E			1.21.6EB1L/□□	E			1.21.A1EB1L/□□	E					1 1		
1.21.45F1B1L/□□				1.21.5F1B1L/□□				1.21.6F1B1L/□□				1.21.A1F1B1L/□□						1 1		
1.21.45E1B1L/□□				1.21.5E1B1L/□□				1.21.6E1B1L/□□				1.21.A1E1B1L/□□						1 1		
1.21.45FB1R/□□	E			1.21.5FB1R/□□	E			1.21.6FB1R/□□	E			1.21.A1FB1R/□□	E					1 1		
1.21.45EB1R/□□	E			1.21.5EB1R/□□	E			1.21.6EB1R/□□	E			1.21.A1EB1R/□□	E					1 1		
1.21.45F1B1R/□□				1.21.5F1B1R/□□				1.21.6F1B1R/□□				1.21.A1F1B1R/□□						1 1		
1.21.45E1B1R/□□				1.21.5E1B1R/□□				1.21.6E1B1R/□□				1.21.A1E1B1R/□□						1 1		
1.21.45FK2		V		1.21.5FK2		V		1.21.6FK2		V		1.21.A1FK2		V				1 1		
1.21.45EK2		V		1.21.5EK2		V		1.21.6EK2		V		1.21.A1EK2		V				1 1		
1.21.45FB2/□□	E			1.21.5FB2/□□	E			1.21.6FB2/□□	E			1.21.A1FB2/□□	E					1 1		
1.21.45EB2/□□	E			1.21.5EB2/□□	E			1.21.6EB2/□□	E			1.21.A1EB2/□□	E					1 1		
1.21.45F2B2/□□				1.21.5F2B2/□□				1.21.6F2B2/□□				1.21.A1F2B2/□□						1 1		
1.21.45E2B2/□□				1.21.5E2B2/□□				1.21.6E2B2/□□				1.21.A1E2B2/□□						1 1		
1.21.45FK3				1.21.5FK3				1.21.6FK3				1.21.A1FK3						1 1		
1.21.45EK3		V		1.21.5EK3		V		1.21.6EK3		V		1.21.A1EK3		V				1 1		
1.21.45FK4				1.21.5FK4				1.21.6FK4				1.21.A1FK4						1 1		
1.21.45EK4		V		1.21.5EK4		V		1.21.6EK4		V		1.21.A1EK4		V				1 1		
												1.21.A2F5						1 1		
												1.21.A2E5						1 1		
				1.21.5/3F5 <sup>2)</sup>								1.21.A3F5						1 1		
				1.21.5/3E5 <sup>2)</sup>								1.21.A3E5						1 1		
												1.21.A3E2-5						1 1		
												1.21.A4F5						1 1		
												1.21.A4E5						1 1		
1.21.45F5												1.21.A45F5						1 1		
1.21.45E5												1.21.A45E5						1 1		
				1.21.5F5								1.21.A5F5						1 1		
				1.21.5E5								1.21.A5E5						1 1		
								1.21.6F5				1.21.A6F5						1 1		
								1.21.6E5				1.21.A6E5						1 1		
				1.21.5/3E2-5								1.21.A3E2-5						1 1		
1.21.B45				1.21.B50				1.21.B60				Cross bushing, steel								
1.21.B45	V			1.21.B50	V			1.21.B60	V			Cross bushing, VA								

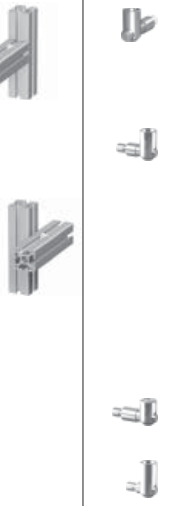

Connector for core hole-Ø 12 mm				Connectors, complete							
				PG 20		PG 30		PG 40			
				steel standard	E	VA	steel standard	E	VA	steel standard	E
	Miter	-hinge l + r	1.21.2G1		V	1.21.3G1		V	1.21.4G1		V
		-bent anchor l + r	1.21.2GB1/□□			1.21.3GB1/□□			1.21.4GB1/□□		
	90°	-hinge l + r	1.21.2G2		V	1.21.3G2		V	1.21.4G2		V
		-bent anchor l	1.21.2GB2L/□□			1.21.3GB2L/□□			1.21.4GB2L/□□		
		-bent anchor r	1.21.2GB2R/□□			1.21.3GB2R/□□			1.21.4GB2R/□□		
	Shifter		1.21.2GS			1.21.3GS			1.21.4GS		
	Extension		1.21.2V0		V	1.21.3V0		V	1.21.4V0		V
						1.21.3/2V0		V	1.21.4/2V0 1.21.4/3V0		V V
	Screw-type	-front sided	1.21.2S1M6/11 1.21.20S1M8/7 1.21.2S1M8/11 1.21.2S1M8/40		V	1.21.3S1M6/11 1.21.30S1M8/7 1.21.3S1M8/11 1.21.3S1M8/40		V	1.21.4S1M6/11 1.21.40S1M8/7 1.21.4S1M8/11 1.21.4S1M8/40		V
		-Parallel-square	1.21.2S5M8/11			1.21.3S5M8/7 1.21.3S5M8/11			1.21.4S5M8/7 1.21.4S5M8/11		
		-Parallel-cross	1.21.2/3S5M8/11			1.21.3/5S5M8/11					
		-Parallel-high				1.21.3/2S5M8/11					

	Cross bushing, steel	1.21.B20		1.21.B30		1.21.B40	
	Cross bushing, VA	1.21.B20	V	1.21.B30	V	1.21.B40	V

						Single parts			1.21.B20	1.21.B30	1.21.B40	1.21.B45	1.21.B50
PG 45		PG 50		PG 60		Anchor		Piece					
steel standard	E	VA steel standard	E	VA steel standard	E	steel standard	E	VA					
1.21.45G1	V	1.21.5G1	V	1.21.6G1	V	1.21.A1G1	V	V	1	2			
1.21.45GB1/□□		1.21.5GB1/□□		1.21.6GB1/□□		1.21.A1GB1/□□			1	2			
1.21.45G2	V	1.21.5G2	V	1.21.6G2	V	1.21.A1G2	V	V	1	2			
1.21.45GB2L/□□		1.21.5GB2L/□□		1.21.6GB2L/□□		1.21.A1GB2L/□□			1	2			
		1.21.5GB245L/□□		1.21.6GB245L/□□		1.21.A1GB245L/□□			1	2			
1.21.45GB2R/□□		1.21.5GB2R/□□		1.21.6GB2R/□□		1.21.A1GB2R/□□			1	2			
1.21.45GS		1.21.5GS		1.21.6GS		1.21.A1GS			1	2			
1.21.45V0	V	1.21.5V0	V	1.21.6V0	V	1.21.A1V0	V	V	1	2	-	-	-
1.21.45/2V0	V	1.21.5/2V0	V	1.21.6/2V0	V	1.21.A1V0	V	V	1	1	1	-	-
1.21.45/3V0	V	1.21.5/3V0	V	1.21.6/3V0	V	1.21.A1V0	V	V	1	1	-	1	-
1.21.45/4V0	V	1.21.5/4V0	V	1.21.6/4V0	V	1.21.A1V0	V	V	1	1	-	-	1
		1.21.5/45V0	V	1.21.6/45V0	V	1.21.A1V0	V	V	1	1	-	-	-
		1.21.6/5V0	V	1.21.A1V0	V	1.21.A1V0	V	V	1	1	-	-	-
1.21.45S1M6/11		1.21.5S1M6/11		1.21.6S1M6/11		1.21.A1SM6/11			1	1			
1.21.45S1M8/7		1.21.5S1M8/7		1.21.6S1M8/7		1.21.A1SM8/7			1	1			
1.21.45S1M8/11	V	1.21.5S1M8/11	V	1.21.6S1M8/11	V	1.21.A1SM8/11	V	V	1	1			
1.21.45S1M8/40		1.21.5S1M8/40		1.21.6S1M8/40		1.21.A1SM8/40			1	1			
						1.21.A2SM8/11			1	1			
						1.21.A3SM8/7			1	1			
						1.21.A3SM8/11			1	1			
						1.21.A4SM8/7			1	1			
1.21.45S5M8/11						1.21.A4SM8/11			1	1			
						1.21.A45SM8/11			1	1			
		1.21.5S5M8/11				1.21.A5SM8/11			1	1			
				1.21.6S5M8/11		1.21.A6SM8/11			1	1			
						1.21.A3SM8/11			1	1			
						1.21.A5SM8/11			1	1			
						1.21.A2SM8/11			1	1			
		1.21.5/3S5M8/11				1.21.A3SM8/11			1	1			
1.21.B45		1.21.B50		1.21.B60		<i>Cross bushing, steel</i>							
1.21.B45	V	1.21.B50	V	1.21.B60	V	<i>Cross bushing, VA</i>							



Parallel connector  
for profile 30×30, soft

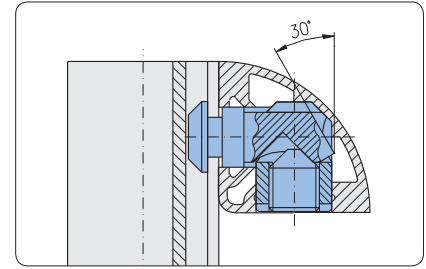

**Application**

Special anchor for parallel connector for profile 30×30, 2 F-slots, soft

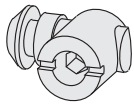

**Description**

Description	Weight	Article-No.
Connector, parallel	40 g	1.21.31E5
Connector, parallel	33 g	1.21.31F5

**Single parts**

Description	Weight	Article-No.
Anchor, incl. spring	23 g	1.21.A31E5
Anchor, incl. spring	16 g	1.21.A31F5
Cross bushing, incl. setscrew	17 g	1.21.B34

Universal connector  
for profile 30×150

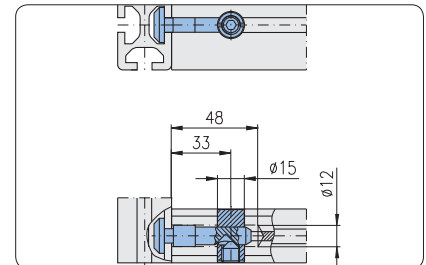

Drill dimensions

**Application**

Universal connector for connection of two profiles 30×150  
Alternative connection possibility  
↔ *ST-Connector, 114*

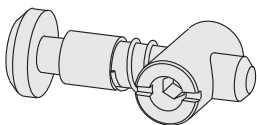

**Description**

Description	Weight	Article-No.
Connector, universal	68 g	1.21.31E0

**Single parts**

Description	Weight	Article-No.
Anchor, incl. spring	41 g	1.21.A1E0
Cross bushing, incl. setscrew	27 g	1.21.B31

Extension / parallel connector

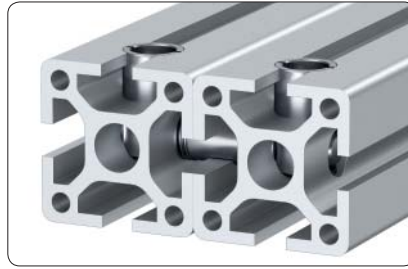

Application

- Parallel connections with core hole distance of 40 mm
- Profile extensions

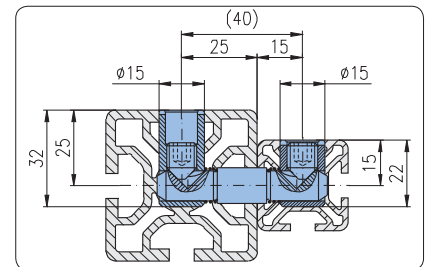
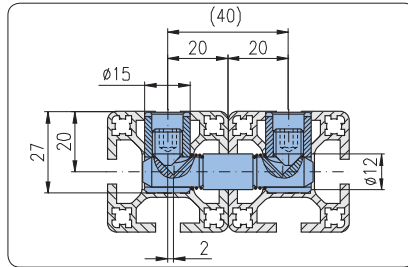

Insert front-sided

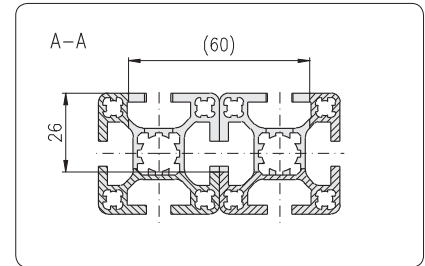

Profile machining

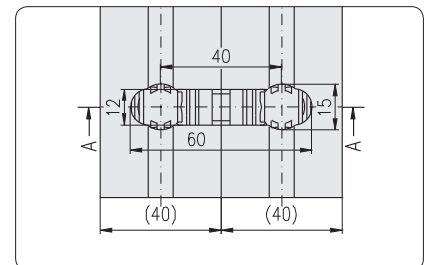

Profile machining

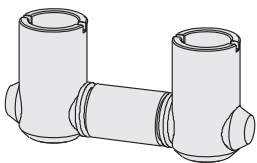

Description	Weight	Article-No.
Connector extension / parallel	76 g	1.21.40V040

Single parts

Description	Pcs	Weight	Article-No.
Anchor for connector extension / parallel, incl. springs	1	36 g	1.21.A1V040
Cross bushing B40, incl. setscrew	2	20 g	1.21.B40

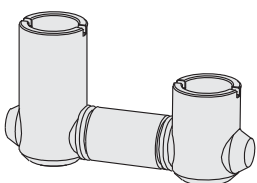

Description	Weight	Article-No.
Connector extension / parallel	76 g	1.21.50/30V040

Single parts

Description	Pcs	Weight	Article-No.
Anchor for connector extension / parallel, incl. springs	1	36 g	1.21.A1V040
Cross bushing B50, incl. setscrew	1	25 g	1.21.B50
Cross bushing B30, incl. setscrew	1	15 g	1.21.B30



Universal connector  
with knurled cross bushing

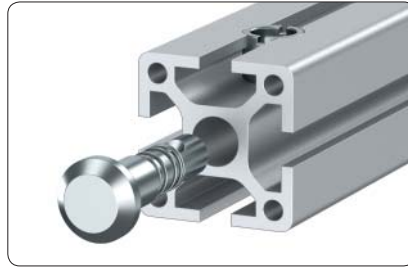

**Application**  
Fixable cross bushing  
Press in device  1.98

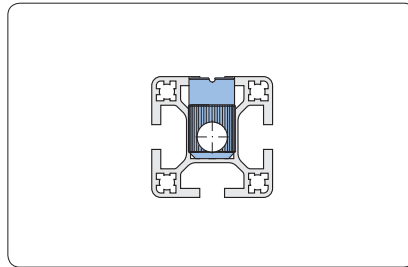

**Comments**  
The knurled cross bushing is suitable for all connectors with the cross bushing 1.21.B40  
 Connector components, 1.2C

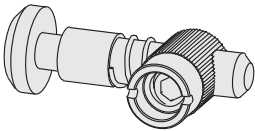

Description	Weight	Article-No.
Connector, universal with knurled cross bushing	60 g	1.21.40RE0

**Single parts**

Description	Pcs	Weight	Article-No.
Anchor, incl. spring	1	40 g	1.21.A1E0
Cross bushing B40, knurled, incl. setscrew	1	20 g	1.21.B40R

SE-Connector

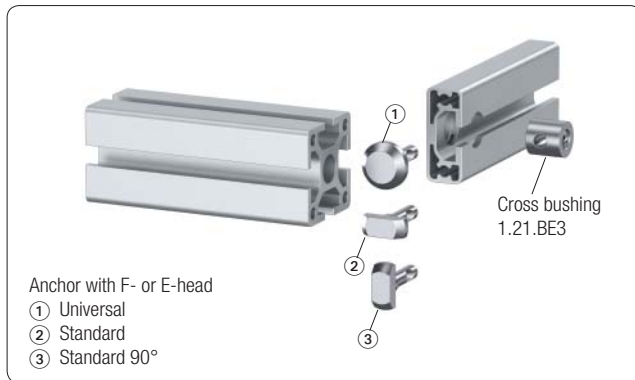

for profiles with E3-slot, PG16, E

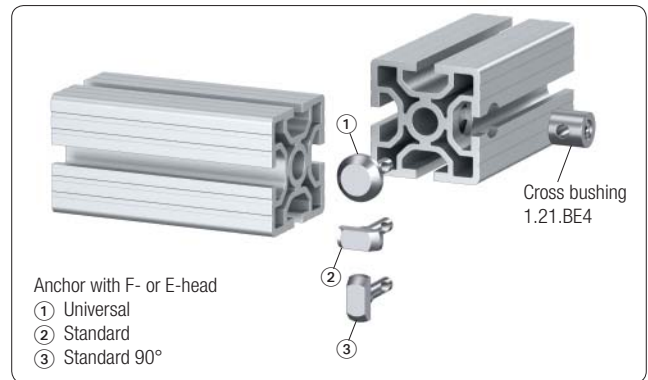

for profiles with E4-slot

Application

- for PG 16 E
- allows mounting of additional profiles into existing frames

Boring depth T	
mounting in	T
E3-slot	15 mm
E4-slot	16 mm

Drill distance L	
mounting on	L
F-slot	16 mm
E3-slot	15 mm
E4-slot	14 mm

Connection		Connection		Connector	Article-No. for SE-connector			
Profile PG16, E3-slot to F/E-slot		Profile with E4-slot to F/E-slot			mounting in E3-slot		mounting in E4-slot	
					steel	VA	steel	VA
Universal		Universal			1.21.SE3F0	1.21.SE3E0	1.21.SE4F0	1.21.SE4E0
Standard		Standard			1.21.SE3F1	1.21.SE3E1	1.21.SE4F1	1.21.SE4E1
90°		90°			1.21.SE3F2	1.21.SE3E2	1.21.SE4F2	1.21.SE4E2

Connectors for E3/E4-slot			Connectors, complete						Single parts			
			mounting in E3-slot			mounting in E4-slot			Anchor			Piece
			steel	VA	steel	VA	steel	VA	steel	VA		
			standard	E	standard	E	standard	E	standard	E		
		Universal	1.21.SE3F0		1.21.SE4F0		1.21.ASEF0				1	1
			1.21.SE3E0		1.21.SE4E0		1.21.ASEE0				1	1
		Standard	1.21.SE3F1		1.21.SE4F1		1.21.ASEF1				1	1
			1.21.SE3E1		1.21.SE4E1		1.21.ASEE1				1	1
		90°	1.21.SE3F2		1.21.SE4F2		1.21.ASEF2				1	1
			1.21.SE3E2		1.21.SE4E2		1.21.ASEE2				1	1
	Cross bushing		1.21.BE3			1.21.BE4						

E = ground-connector, VA = stainless steel 1.4305

ST-Connector



**Application**

Connector for mounting into E-slot and for connection of profiles 30×150  
Alternative connection possibility  
↔ *Universal connector, 110*

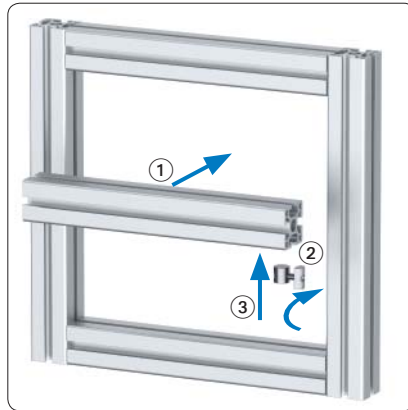

**Application**

ST-Connector for later insertion of profiles into closed frames

**Assembly**

- ① push the profile into the frame
- ② insert and rotate the T-Nut, pretension the screw (and cross bushing)
- ③ push the connector into the cross bushing bore, tighten the screw

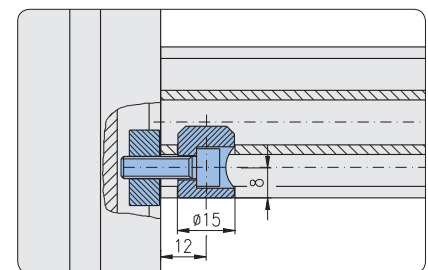
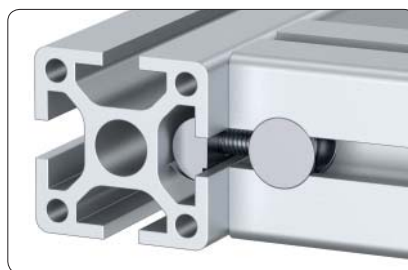
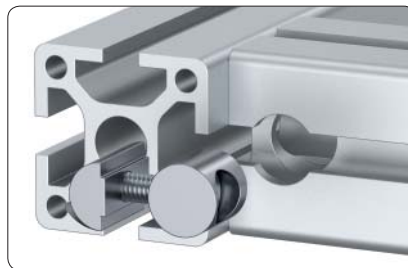

**Technical data**

material: steel  
surface: galvanised  
torque: max. 14 Nm  
tensile load: max. 5,000 N

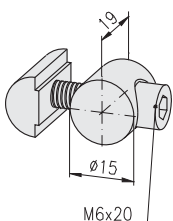

**Connector complete**

Description	G	Weight	Article-No.
ST-Connector	M6	32.0 g	1.21.STEM620

**Single parts**

ST-Cross bushing	M6	16.7 g	1.21.STBM6
T-Nut for subsequent insertion into E-slots	M6	10.0 g	1.32.4EM6
Cap head screw DIN 912	M6×20	5.3 g	0.63.D00912.06020



**ST-Connector  
with anchor, screw-type**



**Application**

ST-Connection for PG 16, E3-slot  
Eco-Slide  $\rightarrow$  1.67

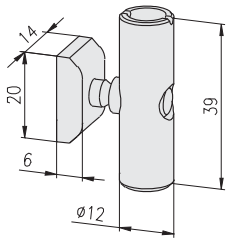
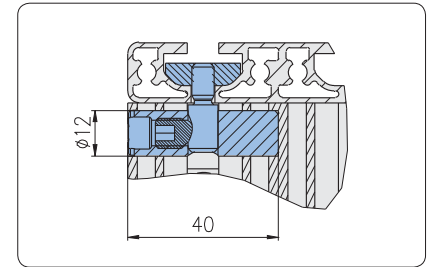
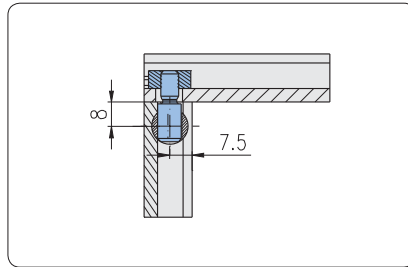

**Connector complete**

Description	G	Weight	Article-No.
ST-Connector with anchor, screw-type	M6	43.8 g	1.21.STESM6/11

**Single parts**

ST-Cross bushing		25.4 g	1.21.STSB40
Threaded plate, heavy, E	M6	12.4 g	1.31.7EM6
Anchor, screw-type, for ST-Connector	M6×11	6.0 g	1.21.ASTM6/11

**Connector screw self-cutting**

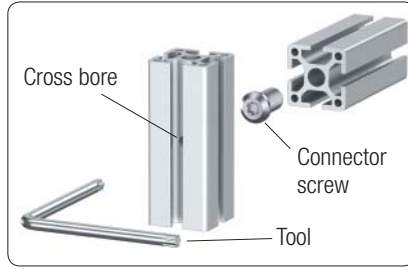

**Application**

Simple connections with profiles using a 12 mm core hole

**Technical data**

material: steel 8.8  
surface: galvanised

**Tool**

Tx screw driver for Torx® 40 screws  
1.98.T40.090090

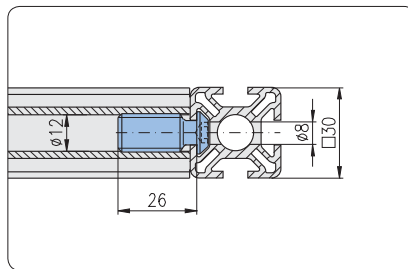
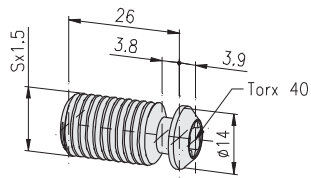

Description	S	Weight	Article-No.
Connector screw, self-cutting, F, S12.8, light		25.0 g	1.21.VSFS128L
Connector screw, self-cutting, F, S12.6, heavy		25.0 g	1.21.VSFS126S

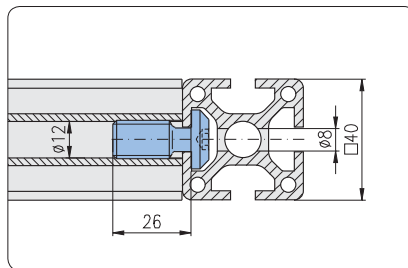
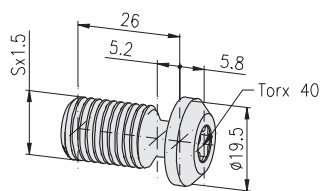

Description	S	Weight	Article-No.
Connector screw, self-cutting, E, S12.8, light		31.5 g	1.21.VSES128L
Connector screw, self-cutting, E, S12.6, heavy		31.5 g	1.21.VSES126S

Cross connector



**Application**

- quick assembly
- connection without profile machining

**Technical data**

Lower section, upper section, bolt, screw:

material: steel  
surface: galvanised

Assembly

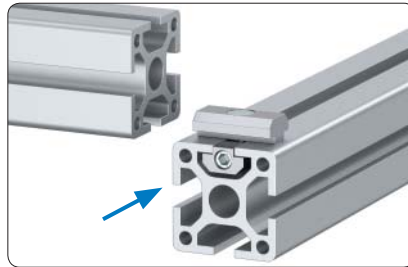

push the lower section of the cross connector into the slot of the first profile

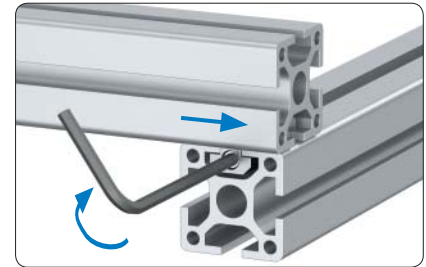

slide the slot of the second profile onto the upper section, position the profiles and tighten the connector

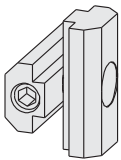

**Description**

Cross connector E3

**Weight**

53.5 g

**Article-No.**

1.25.41.E3

Cross connector E4

55.0 g

1.25.41.E4

Parallel connector  
for subsequent insertion



Application

- quick assembly
- connection without profile machining

Assembly



position the setscrew



insert the T-Nut



insert and pretension the anchor

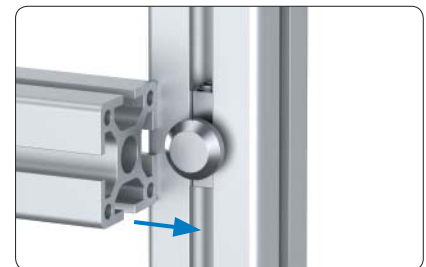

push on and position the profile



fasten the setscrew

Technical data

material: steel  
surface: galvanised

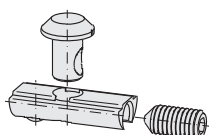

Description	Weight	Article-No.
Parallel connector, for subsequent insertion, E3/H	21.7 g	1.25.E3H/5
Parallel connector, for subsequent insertion, E3/F	24.6 g	1.25.E3F/5
Parallel connector, for subsequent insertion, E3/E3	32.6 g	1.25.E3E3/5
Parallel connector, for subsequent insertion, E4/F	25.0 g	1.25.E4F/5
Parallel connector, for subsequent insertion, E4/E3	33.2 g	1.25.E4E3/5
Parallel connector, for subsequent insertion, E4/E4	33.5 g	1.25.E4E4/5

Insertion connector



**Application**

Connection without profile machining.  
Suitable for the connection of profiles with E-slots to profiles with E- or F-slots.

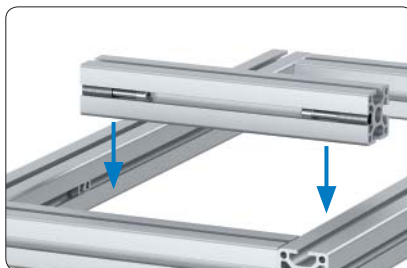
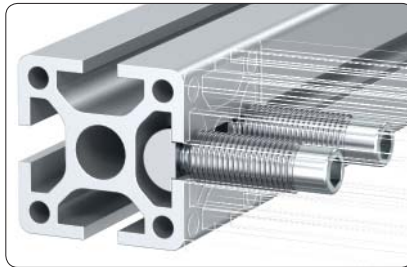

**Application**

Suitable for the subsequent mounting of profiles

Pre-assembly of the threaded sleeve



threaded sleeve with screw

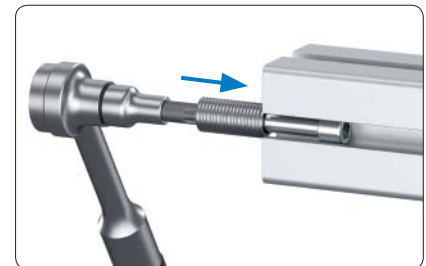

insert the sleeve with screw into the slot

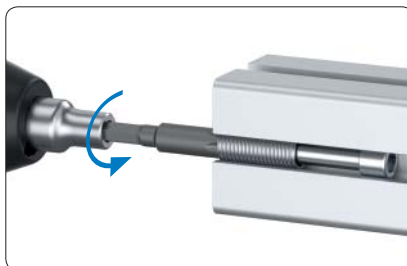

screw in the sleeve

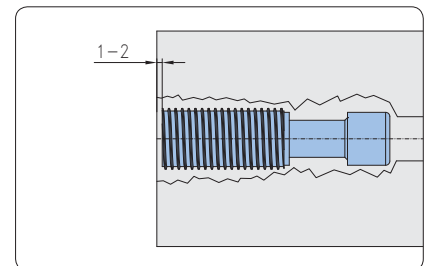

end position of the sleeve



press the screw with a screwdriver through the sleeve

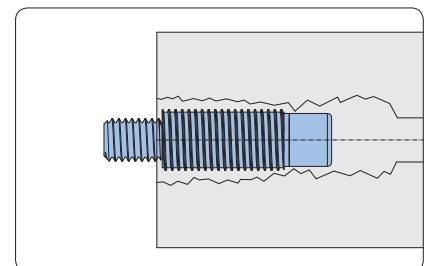

end position of the screw



**Final assembly**

Insertion connector with T-Nut

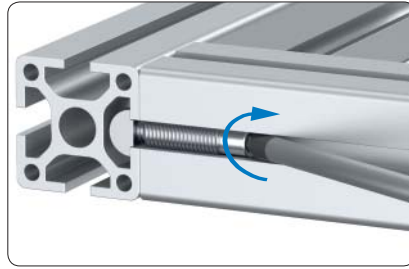

insert T-Nut in slot of the opposition profile and tighten screw

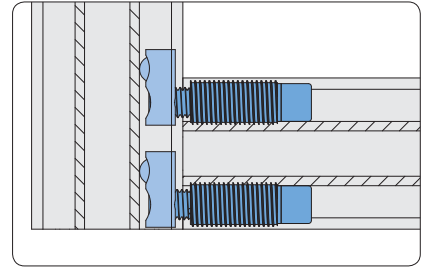

T-Nut for subs. insertion w. spring ball, E, M8; either with one or two connectors

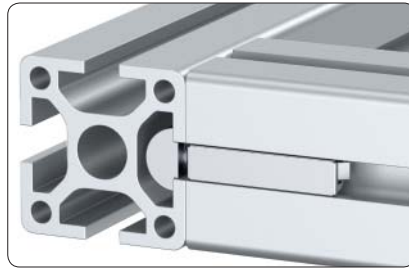

**Optional**

clip on the connector cover

**Final assembly**

Insertion connector with threaded plate

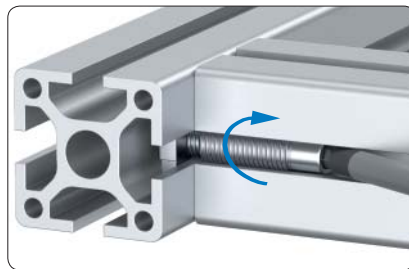

insert threaded plate in slot of the opposition profile and tighten screw

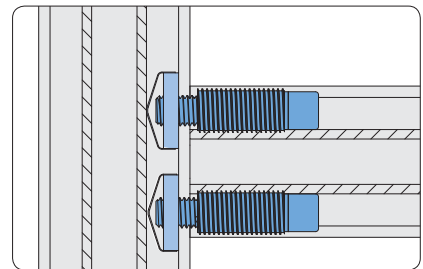

threaded plate, E, M8; either with one or two connectors

Insertion connector

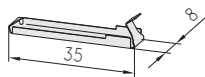
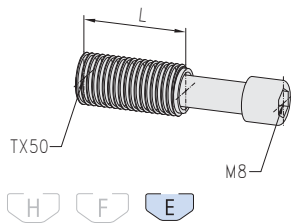
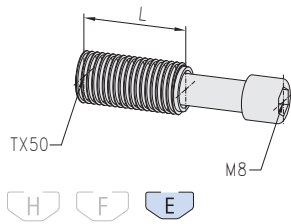

Technical data

Threaded sleeve, screw:  
 material: steel  
 surface: galvanised  
 max. moment of torque:  $M_{A, max}$   
 torque resistance: R

Suitable fastening elements for E-slots

Threaded plate  
 - heavy, E, M8 1.31.6EM8  
 - E, M8 1.31.EM8  
 T-Nut  
 - for subs. ins. w. spring b., E, M8 1.32.3EM8  
 - for subs. ins. w. spring, E, M8 1.32.4EM8  
 - with spring, E, M8 1.32.EM8

Description	L	$M_{A, max}$	R	Weight	Article-No.
Insertion connector	24	22 Nm	low	20 g	1.26.EM8.24L

Description	L	$M_{A, max}$	R	Weight	Article-No.
Insertion connector	24	25 Nm	high	20 g	1.26.EM8.24S
Insertion connector	32	25 Nm	high	27 g	1.26.EM8.32S

Description	Weight	Article-No.
Connector cover stainless for insertion connector L24	0.5 g	1.26.EM8.A24

Torx® Tools

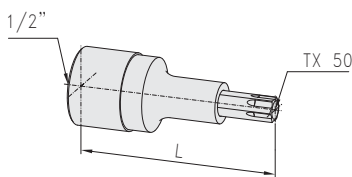
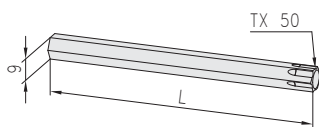
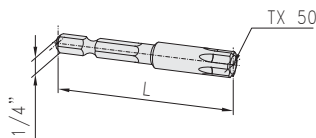

Description	L	Drive	Weight	Article-No.
Screw bit TX 50	50	1/4"	16 g	1.98.TX50A1/4

Description	L	Drive	Weight	Article-No.
Screw bit TX 50	95	9	49 g	1.98.TX50A09

Description	L	Weight	Article-No.
Screwdriver insert TX 50	55	72 g	1.98.TX50A1/2

Hexagonal tools

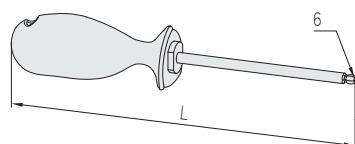
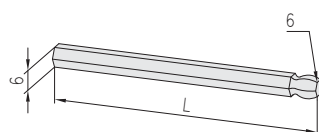

Comments

Tools only for pre-assembly

Description	L	Drive	Weight	Article-No.
Hexagonal bit with ballhead wrench size 6	100	6	23 g	1.98.IN.SW6.100

Description	L	Weight	Article-No.
Hexagonal screwdriver with ballhead wrench size 6	215	122 g	1.98.IN.SW6.215

Connection of  
O-slot profiles

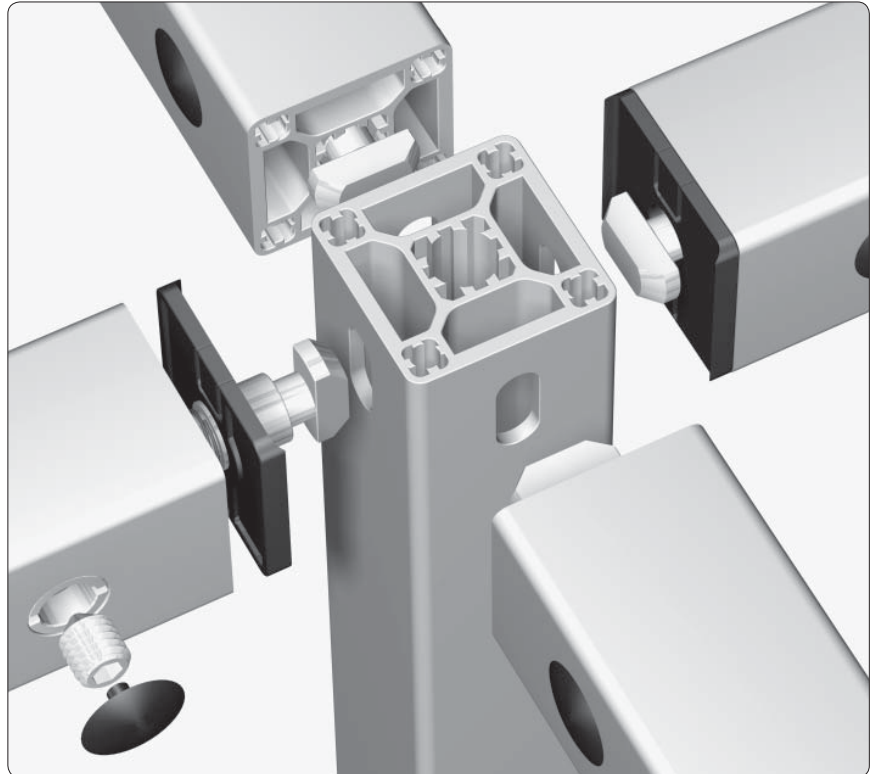

**Comments**

Connector ↗ 1.2A

**Connector - drill dimensions**

without radius covers

PG 30	PG 40
<p>Drill dimensions without radius covers</p>	<p>Drill dimensions without radius covers</p>
<p>Drill dimensions with radius covers</p>	<p>Drill dimensions with radius covers</p>

with radius covers

↗ 1.43

**Cover plug**

for connector cross bushings

↗ 1.42

PG 30	PG 40

Specification of milling patterns  
for closed profiles

VB□□□ / □□□□-□□.□	Key
VB□□□ / □□□□-□□.□	Shortcut for "Verbinder-Bohrung"
VB□□□ / □□□□-□□.□	Specification of the milling pattern <sup>1)</sup>
VB□□□ / □□□□-□□.□	Number of pattern elements <sup>2)</sup>
VB□□□ / □□□□-□□.□	Direction of the profile side ↗ 61
VB□□□ / □□□□-□□.□	Distance of the reference point to the left end of the profile [mm]
VB□□□ / □□□□-□□.□	Angle of the connection (in case of VB3 or VB4)

- <sup>1)</sup> 1 = "T" shape milling pattern for standard connector (Standard)  
↗ 124
- 2 = upside-down "T" shape milling pattern for standard connector  
↗ 125
- 5 = elongated hole for connection  
- with standard connectors ↗ 126  
- with T-Nuts ↗ 127
- 6 = half circle for miter 3-way connection ↗ 128
- <sup>2)</sup> Specification with "A", "B", "C", same as for the amount of cross  
bushing bores ↗ 60

**Mounting variation**

for profiles with 1 or more connectors, if the profile cannot be rotated

for high sliding load

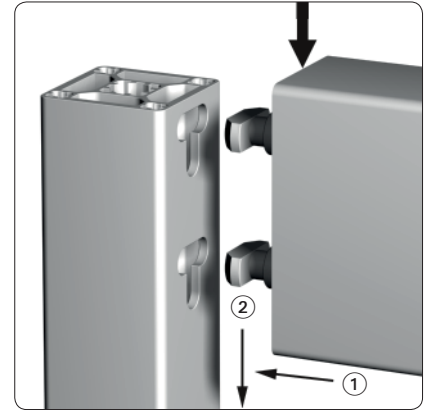
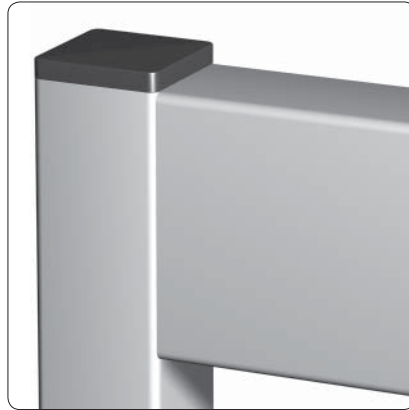

**Comments**

Position of assembly: profiles flush on the top

**Assembly**

- ① insert connector
- ② push profile to the bottom

**Fabrication measurements**

PG 30	PG 40	PG 45
<p>For fastening of profile 30×30</p>	<p>For fastening of profile 40×40</p>	<p>For fastening of profile 45×45</p>
Machining data VB1A□/□□□□		
<p>For fastening of profile 30×60</p>	<p>For fastening of profile 40×80</p>	<p>For fastening of profile 45×90</p>
Machining data VB1B□/□□□□		
<p>For fastening of profile 60×60</p>	<p>For fastening of profile 80×80</p>	<p>For fastening of profile 90×90</p>
Machining data VB1D□/□□□□		

**Mounting variation**

for profiles with 1 or more connectors, if the profile cannot be rotated

for high flexure load

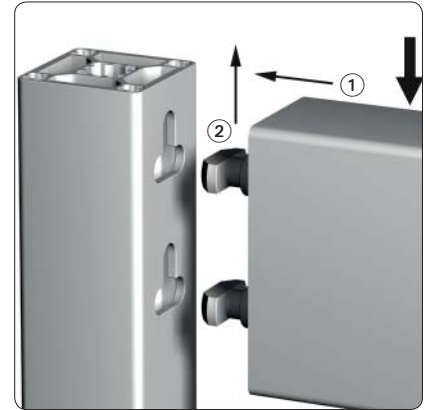
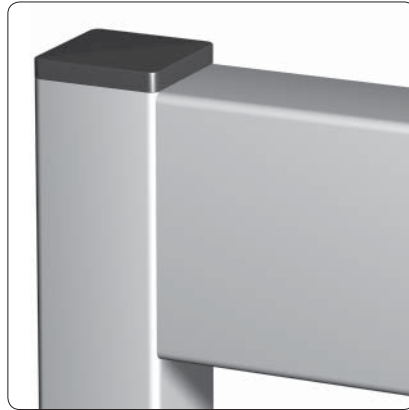

**Comments**

Position of assembly: profiles flush on the top

**Assembly**

- ① insert connector
- ② push profile to the top

**Fabrication measurements**

PG 30	PG 40	PG 45
<p>For fastening of profile 30×30</p>	<p>For fastening of profile 40×40</p>	<p>For fastening of profile 45×45</p>
Machining data VB2A□/□□□□		
<p>For fastening of profile 30×60</p>	<p>For fastening of profile 40×80</p>	<p>For fastening of profile 45×90</p>
Machining data VB2B□/□□□□		
<p>For fastening of profile 60×60</p>	<p>For fastening of profile 80×80</p>	<p>For fastening of profile 90×90</p>
Machining data VB2D□/□□□□		



**Connection with standard connectors**

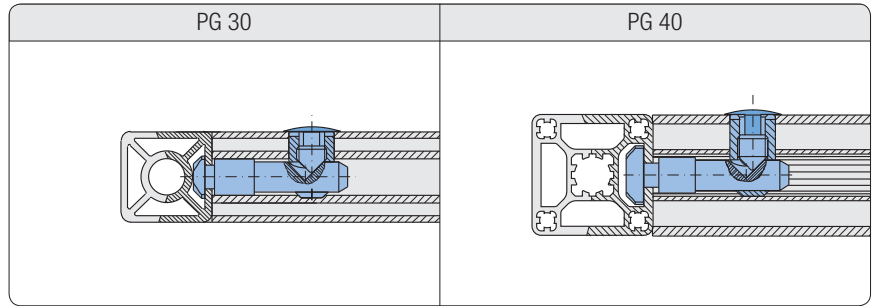

**Single parts**

Connector, standard 1.21.3F1 (V)  
 Connector, standard 90° 1.21.3F2 (V)

**Single parts**

Connector, standard 1.21.4E1 (V)  
 Connector, standard 90° 1.21.4E2 (V)

**Mounting variation for profiles with 1 connector**

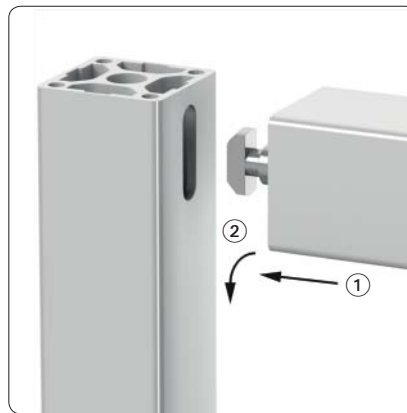

**Assembly**

- ① insert connector
- ② turn profile

**Fabrication measurements**

PG 30	PG 40	PG 45
<p>For fastening of profile 30×30</p>	<p>For fastening of profile 40×40</p>	<p>For fastening of profile 45×45</p>
<p>Machining data VB5A□/□□□□</p>		

Connection with screw-type connectors

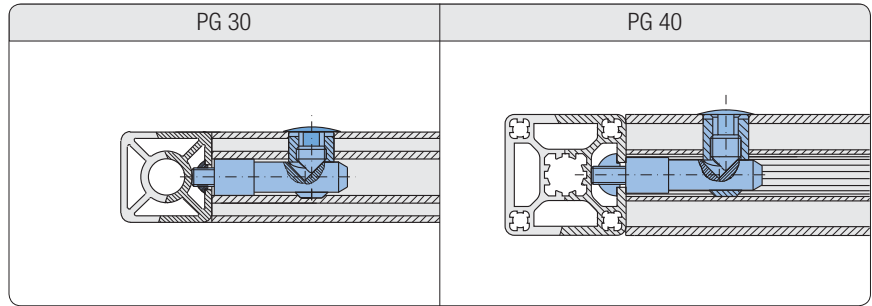

Single parts

- Screw-type connector 1.21.30S1M8/7 (V)
- T-Nut for subsequent insertion, with spring, F 1.32.4FM8 (V)

Single parts

- Screw-type connector 1.21.4S1M8/11 (V)
- T-Nut for subsequent insertion, with spring, E 1.32.4EM8 (V)

Fabrication measurements

PG 30	PG 40	PG 45
<p>For fastening of profile 30×30</p> <p>Machining data VB5A□/□□□□</p>	<p>For fastening of profile 40×40</p>	<p>For fastening of profile 45×45</p>
<p>For fastening of profile 30×60</p> <p>Machining data VB5B□/□□□□</p>	<p>For fastening of profile 40×80</p>	<p>For fastening of profile 45×90</p>
<p>For fastening of profile 60×60</p> <p>Machining data VB5D□/□□□□</p>	<p>For fastening of profile 80×80</p>	<p>For fastening of profile 90×90</p>





**Assembly variation**  
for 3-way connection with miter connectors

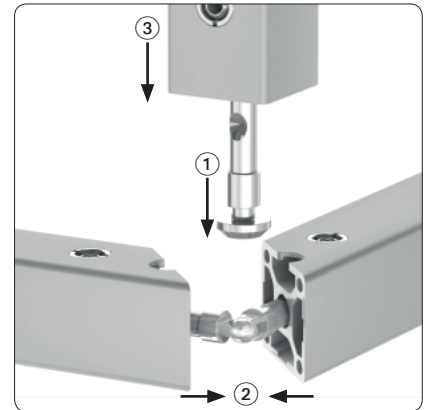

**Assembly**

- ① Capture anchor head between profiles
- ② Ease profiles together
- ③ Tighten anchors joining profile

**Fabrication measurements**

PG 30	PG 40
<p>For fastening of profile 30×30</p>	<p>For fastening of profile 40×40</p>
<p>Machining data VB6A□/□□□□-□□.□</p>	
	<p>For fastening of profile 80×80</p>
	<p>Machining data VB6B□/□□□□-□□.□</p>

## Connection of profiles 40, round

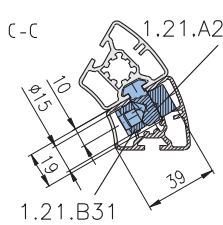
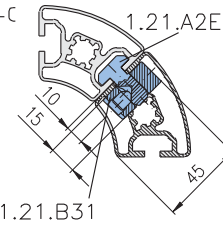
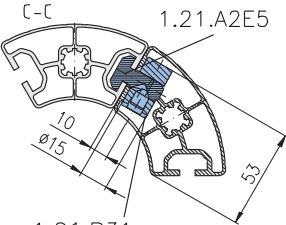
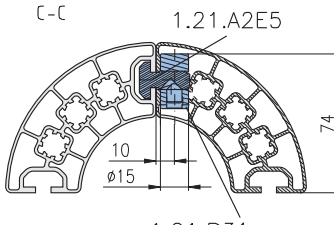

Drill dimensions for profiles 40, round			
30°		45°	
60°		90°	

## Calculation formulas for polygons

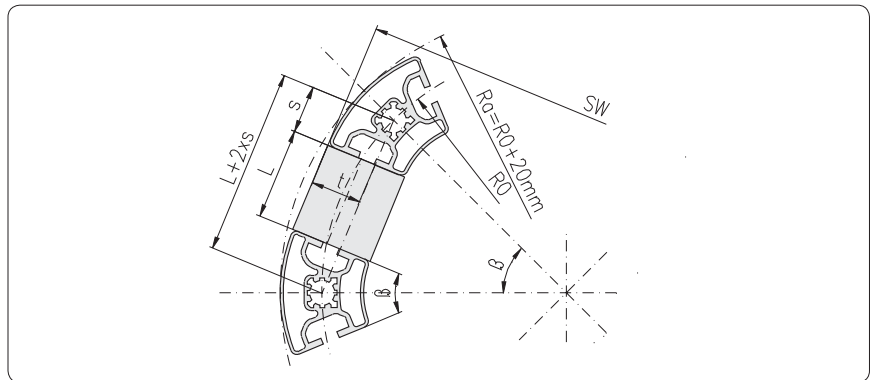

known	searched	Profile 40, round 30° ( $\beta = 30^\circ$ )	Profile 40, round 45° ( $\beta = 45^\circ$ )	Profile 40, round 60° ( $\beta = 60^\circ$ )
			$t = 22.04$ $s = 15.53$	$t = 24.57$ $s = 22.96$
$R_0$	$L =$	$R_0 \times 0,51764 - 31,06$	$R_0 \times 0,76537 - 45,92$	$R_0 - 60$
$R_a$	$L =$	$(R_a - 20) \times 0,51764 - 31,06$	$(R_a - 20) \times 0,76537 - 45,92$	$R_a - 80$
$SW$	$L =$	$\frac{SW - 44,08}{\sqrt{3,73205}} \times 0,51764 - 31,06$	$\frac{SW - 49,14}{\sqrt{3,4142}} \times 0,76537 - 45,92$	$\frac{SW - 56,08}{\sqrt{3}} - 60$
$SW$	$R_0 =$	$\frac{SW - 44,08}{\sqrt{3,73205}}$	$\frac{SW - 49,14}{\sqrt{3,4142}}$	$\frac{SW - 56,08}{\sqrt{3}}$
$SW$	$R_a =$	$\frac{SW - 44,08}{\sqrt{3,73205}} + 20$	$\frac{SW - 49,14}{\sqrt{3,4142}} + 20$	$\frac{SW - 56,08}{\sqrt{3}} + 20$
$R_0$	$SW =$	$\sqrt{(R_0 \times 2)^2 - (R_0 \times 0,51764)^2 + 44,08}$	$\sqrt{(R_0 \times 2)^2 - (R_0 \times 0,76537)^2 + 49,14}$	$\sqrt{(R_0 \times 2)^2 - R_0^2 + 56,08}$
$R_a$	$SW =$	$\sqrt{((R_a - 20) \times 2)^2 - ((R_a - 20) \times 0,51764)^2 + 44,08}$	$\sqrt{((R_a - 20) \times 2)^2 - ((R_a - 20) \times 0,76537)^2 + 49,14}$	$\sqrt{((R_a - 20) \times 2)^2 - R_a^2 + 56,08}$

Subsequent mounting of profiles

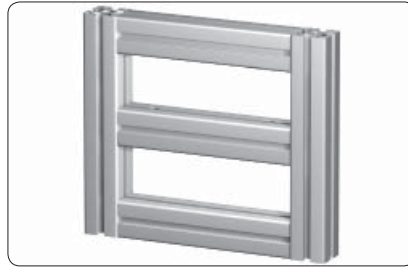

Step by step instruction for subsequent mounting of profiles with two standard connections for all profile groups

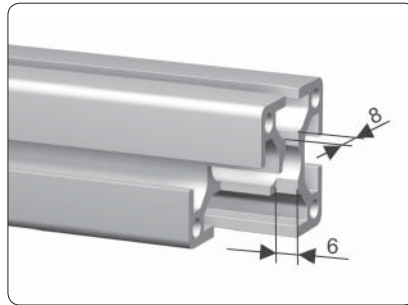

For the subsequent mounting of the profile:

1. Mill on both ends a slot size of 6×8 mm.

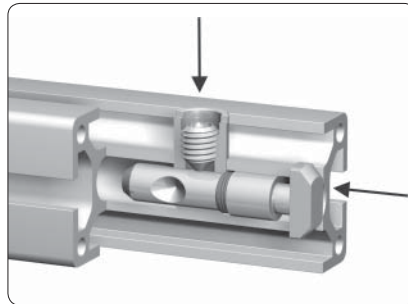

2. Mount connector and fix anchor in front position with setscrew.

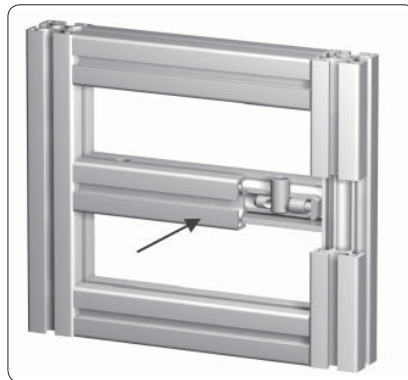

3. Mount profile.

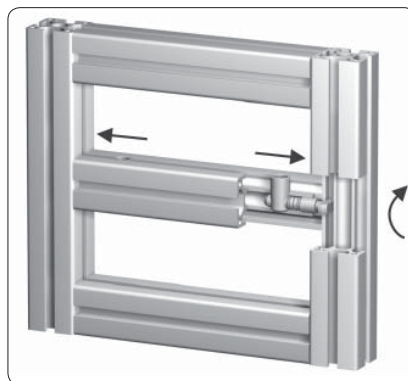

4. Loosen setscrew.  
Due to the compressing spring the anchor is pushed into the slot.  
Turn anchor by 90° with screw driver.  
Fasten setscrew.

Connection of MayTec with other profile systems

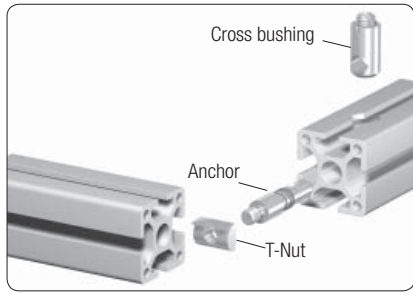

MayTec profiles can easily be combined with other profile systems.

With the MayTec Screw-type connector and the T-Nut of the other profile system

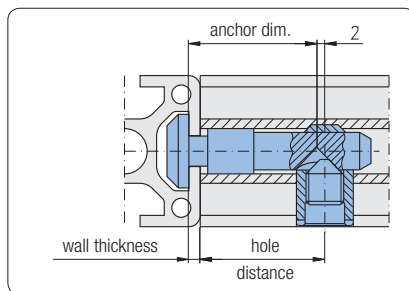
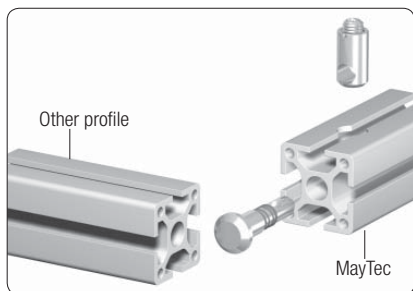
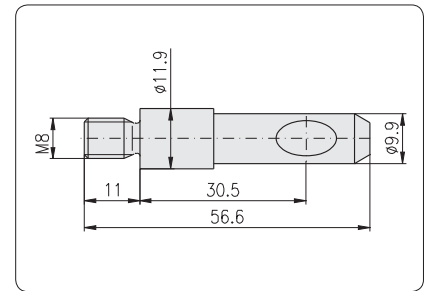
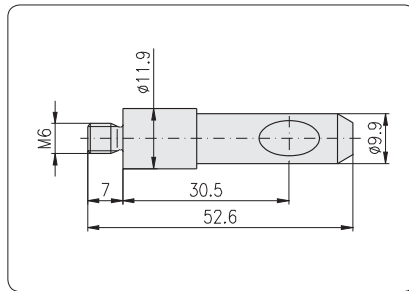
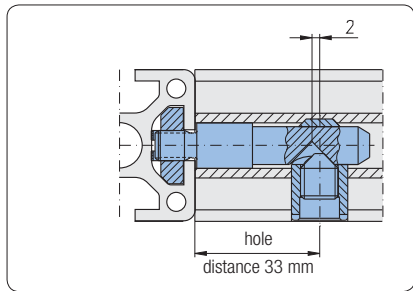
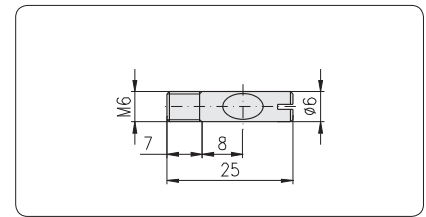
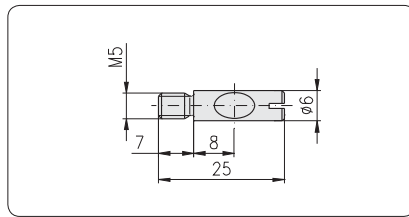
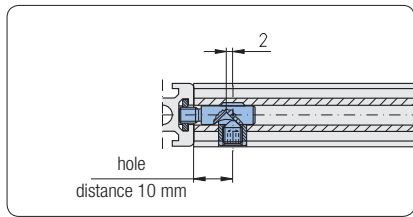

With the MayTec Standard-connector two points have to be considered:

1. Anchor head-form and size

The MayTec system provides 3 anchor head sizes. If any of the sizes don't fit into the slots of other profile systems, the anchor head can be made to fit as required.

2. Hole distance

During the machining of the cross bore the hole distance has to match the wall thickness of the profile.

$$\text{hole distance} = \text{anchor dim.} - \text{wall thickness} + 2 \text{ mm}$$

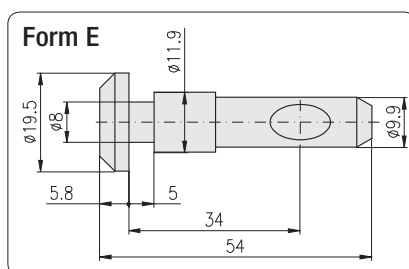
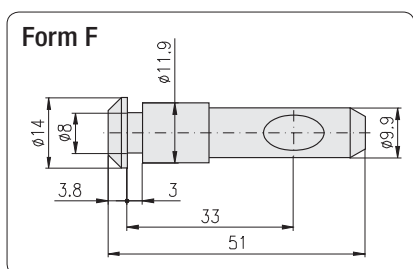
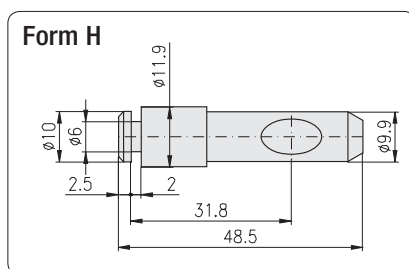
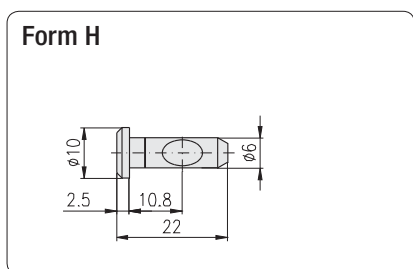

2

### Torque tightening values for connector setscrew

PG	Slot	Setscrew special execution	Torque value	
			recommended	max.
20	H	M6×8	5.0 Nm	6.0 Nm
	F	M8×10	15.0 Nm	20.0 Nm
30	F	M10×12	25.0 Nm	30.0 Nm
40	E	M10×12	30.0 Nm	40.0 Nm
45	E	M10×12	30.0 Nm	40.0 Nm
50	E	M10×12	30.0 Nm	40.0 Nm
60	E	M10×12	30.0 Nm	40.0 Nm

### Comments

The max. tightening values are only valid for the MayTec setscrew and can not be reached by the usual commercial quality standard.

### Tension load

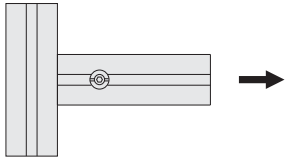

PG	Slot	max. Tensile strength				
		Connector			T-Nut	
		Standard	Universal	Square head		
20	H	-	1,500 N	-	M4	4,000 N
	F	5,000 N	6,000 N	8,000 N	M8	8,000 N
30	F	5,000 N	6,000 N	8,000 N	M8	8,000 N
40	E	10,000 N	12,000 N	12,000 N	M8	12,000 N
45	E	15,000 N	18,000 N	20,000 N	M8	20,000 N
50	E	15,000 N	18,000 N	20,000 N	M8	20,000 N
60	E	15,000 N	18,000 N	20,000 N	M8	20,000 N

### Comments

All values given have been tested with pre-tension of the connectors and maximum torque value and refer to the connection of two identical profiles.

### Slide load

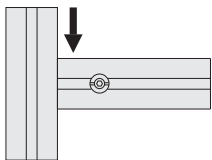

### Flexure load

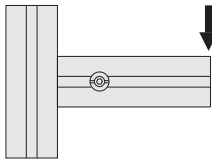

PG	Profile	Slot	Pcs	max. Slide strength		max. Flexure strength		
				Standard, Universal, Square head	E-connector (Standard, Universal)	Connector		
						Standard, Universal, Square head		
20	20×20	H	1	1,500 N	-	50 Nm	100 Nm	150 Nm
	20×40		2	3,000 N	-			
	40×40	F	4	6,000 N	-	300 Nm		65 Nm
	20×30		1	5,000 N	7,500 N			
30	30×30	F	1	5,000 N	7,500 N	100 Nm	100 Nm	160 Nm
	30×50		1	5,000 N	7,500 N			
	30×60	2	10,000 N	15,000 N	200 Nm	400 Nm		
	30×100, 5F	2	10,000 N	15,000 N				
	30×100, 8F	3	15,000 N	22,500 N	300 Nm	960 Nm		
	30×150, 8F	3	15,000 N	22,500 N				
	60×60 angle	3	15,000 N	22,500 N	500 Nm	1,500 Nm		
	60×60	4	20,000 N	30,000 N				
	30×150	E	2	12,000 N	18,000 N	800 Nm	500 Nm	2,000 Nm
	40	40×40	E	1	6,000 N	9,000 N	250 Nm	250 Nm
40×60		1		6,000 N	9,000 N			
40×80		2	12,000 N	18,000 N	500 Nm	1,000 Nm		
40×120		3	18,000 N	27,000 N				
40×160		4	24,000 N	36,000 N	1,000 Nm	4,000 Nm		
80×80 angle		3	18,000 N	27,000 N				
80×80, 8E		4	24,000 N	36,000 N	1,250 Nm	4,500 Nm		
80×120		6	36,000 N	54,000 N				
120×120		8	48,000 N	72,000 N	2,000 Nm	8,000 Nm		
80×160		8	48,000 N	72,000 N				
45	45×45	E	1	6,000 N	9,000 N	360 Nm	360 Nm	480 Nm
	45×60		1	6,000 N	9,000 N			
	45×90	2	12,000 N	18,000 N	720 Nm	1,440 Nm		
	90×90	4	24,000 N	36,000 N				
50	50×50	E	1	6,000 N	9,000 N	400 Nm	800 Nm	1,600 Nm
	50×100, 6E		2	12,000 N	18,000 N			
	50×100, 8E	3	18,000 N	27,000 N	1,200 Nm	2,400 Nm		
	50×150	3	18,000 N	27,000 N				
	100×100	4	24,000 N	36,000 N	3,200 Nm	6,400 Nm		
	100×200	8	48,000 N	72,000 N				
60	60×60	E	1	6,000 N	9,000 N	480 Nm	960 Nm	1,440 Nm
	60×90		2	12,000 N	18,000 N			

The listed values are valid for all light and heavy profiles

Anti-twist devices

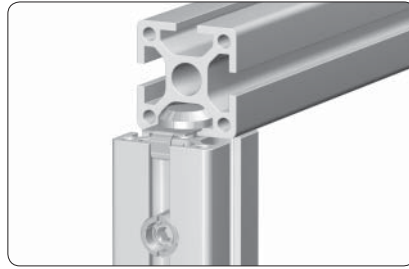

**Technical data**

material: steel  
 surface: galvanised

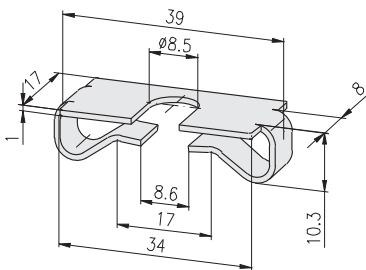

**Description**

Anti-twist device for connector

**Weight**

11 g

**Article-No.**

1.29.11240

Anti-twist devices

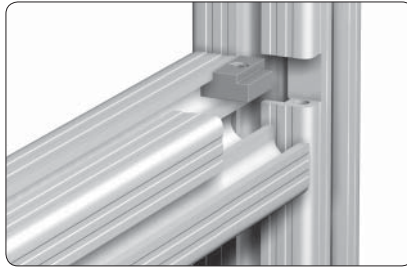

Application

In the case of high torque forces with connections of one connector only, twisting can be prevented by mounting 1 or 2 anti-twist devices.

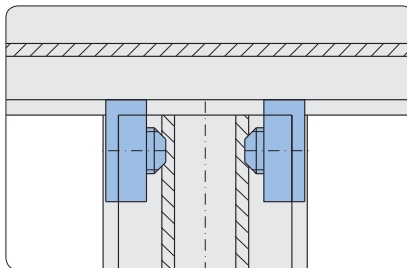

The nose of the anti-twist device fits into the basic profile.

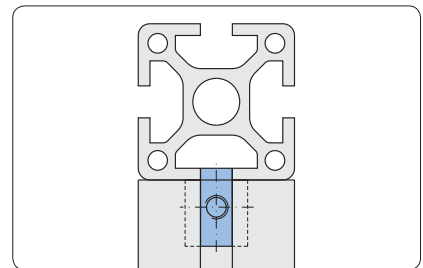

Technical data

material: steel  
 surface: galvanised  
 max. moment of torque:  $M_{A, max}$

Fastening elements

F-slot:  
 Setscrew M6×8 1.20.G0608  
 E-slot:  
 Setscrew M6×12 1.20.G0612

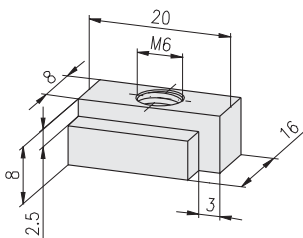
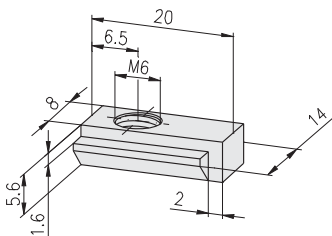

Description	G	$M_{A, max}$	Weight	Article-No.
Anti-twist device F	M6	10 Nm	7.3 g	1.29.321.FM6

Description	G	$M_{A, max}$	Weight	Article-No.
Anti-twist device E	M6	10 Nm	14 g	1.29.321.EM6

Anti-twist devices  
for subsequent insertion



Application

In the case of high torque forces with connections of one connector only, twisting can be prevented by mounting 1 or 2 anti-twist devices.

- for subsequent insertion

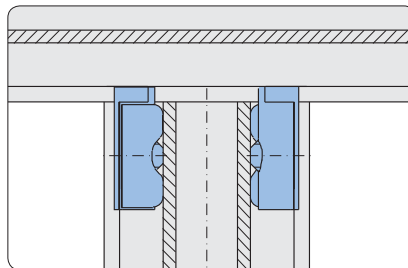

The nose of the anti-twist device fits into the basic profile.

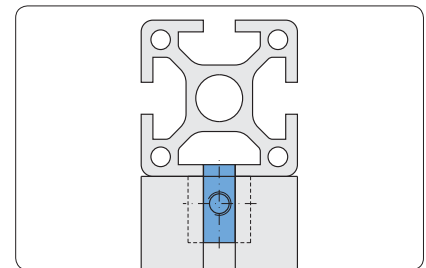

Technical data

material: steel  
surface: galvanised  
max. moment of torque:  $M_{A, max}$

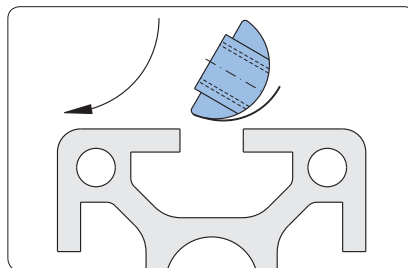

Insert front-sided and rotate

Fastening elements

F-slot:  
Setscrew ISO 4026 M6×8 1.20.G0608  
E-slot:  
Setscrew ISO 4026 M6×12 1.20.G0612

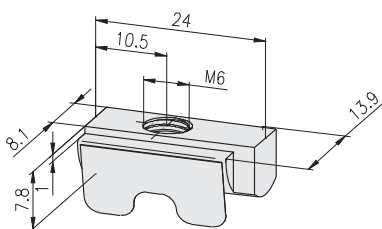
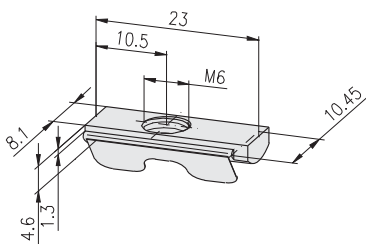

Description	G	$M_{A, max}$	Weight	Article-No.
Anti-twist device F	M6 for subsequent insertion	10 Nm	7.3 g	1.29.324.FM6

Description	G	$M_{A, max}$	Weight	Article-No.
Anti-twist device E	M6 for subsequent insertion	10 Nm	14 g	1.29.324.EM6



Clamping levers

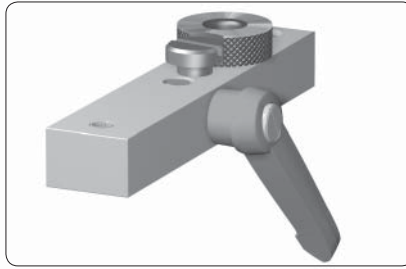

Clamping lever for drill jigs

Application

Any MayTec connector can be equipped with a clamping lever.  
For frequent opening and closing



Clamping lever for connector

Technical data

clamping handle: PA-glass-fiber reinf.  
clamping lever: with ratchet lever handle  
annular gear: die casted zinc  
thread: steel

Clamping levers 40  
for connector

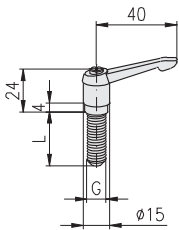

Description	G	L	Weight	Article-No.
Clamping lever 40 for connector	M6	20	17 g	1.29.500620
Clamping lever 40 for connector	M8	20	21 g	1.29.500820
Clamping lever 40 for connector	M10	20	24 g	1.29.501020
Clamping lever 40 for connector	M10	30	29 g	1.29.501030

Clamping levers 65  
for connector

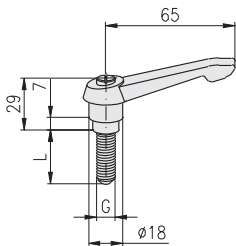

Description	G	L	Weight	Article-No.
Clamping lever 65 for connector	M6	20	36 g	1.29.650620
Clamping lever 65 for connector	M8	20	41 g	1.29.650820
Clamping lever 65 for connector	M8	30	43 g	1.29.650830
Clamping lever 65 for connector	M10	20	44 g	1.29.651020
Clamping lever 65 for connector	M10	30	49 g	1.29.651030

Clamping levers 80  
for connector

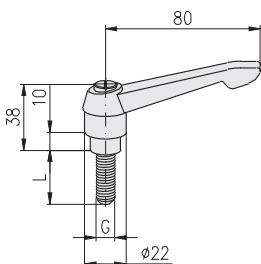

Description	G	L	Weight	Article-No.
Clamping lever 80 for connector	M8	20	64 g	1.29.800820
Clamping lever 80 for connector	M10	20	65 g	1.29.801020
Clamping lever 80 for connector	M10	30	70 g	1.29.801030

1.3 Fastening elements



Threaded plates  
↗ 142



Threaded plates for subs. insertion  
↗ 143



Threaded plates heavy  
↗ 144



T-Nuts  
↗ 145



T-Nuts for subs. insertion  
↗ 146-148



Spring-nuts front-sided insertion  
↗ 149



T-slot nuts  
↗ 150



Rhomboid T-slot nuts with self-locking  
↗ 151



T-Bolts front-sided insertion  
↗ 152



Threaded inserts  
↗ 153-154



Press-fit threaded inserts  
↗ 155-156

1.4 Installation accessories



Cover profiles  
↗ 157



Cover profiles  
↗ 157



Sliding and cover profiles  
↗ 158



Reducing profiles  
↗ 159



Combination profiles  
↗ 160



Combination profiles  
↗ 161



Combination profiles for sliding profiles  
↗ 163



Guide profile for sliding profile  
↗ 164



Framing profiles one piece  
↗ 165



Wedge profiles  
↗ 166



Sponge rubber round cords  
↗ 167-168



Sealing profile  
↗ 169



Framing profiles  
↗ 170-171



Rubber cover-profiles  
↗ 172



Cover caps for profiles  
↗ 173-175



Cover cap Ø48 for hand rail profile  
↗ 175



Cover plugs for cross bushings  
↗ 176



Cover plugs domed for cross bushings  
↗ 177



Cover caps for tubes  
↗ 178



Cover caps for screw bores  
↗ 178

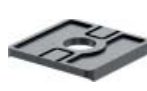

Radius covers  
↗ 179-180



Radius compensations  
↗ 181



Floor levelling screws  
↗ 182



Levelling foot PA 20  
↗ 182



Hand adjustable feet  
↗ 183



Levelling feet  
↗ 184



Adjustable tilt-feet  
↗ 185-189



Angular adjusting feet  
↗ 190



Base foot  
↗ 191



Base feet  
↗ 192-196



Base angle  
↗ 197



Stacking foot  
↗ 197



Fixed castors  
↗ 198



Swivel castors  
↗ 199



Swivel castors lockable  
↗ 199



Locking castors  
↗ 200-201



Angles  
↗ 202



Angles PA  
↗ 203



Angles GD-Zn  
↗ 204-206



Angles GD-Al  
↗ 207



Angles Alu  
↗ 208



Swivel angles straight design  
↗ 209



Swivel angles  
↗ 209-210



Cross connection plates  
↗ 210



Base plates  
↗ 211-212



Floor mounting plate  
↗ 213



Mounting plates  
↗ 214



Floor plate  
↗ 214

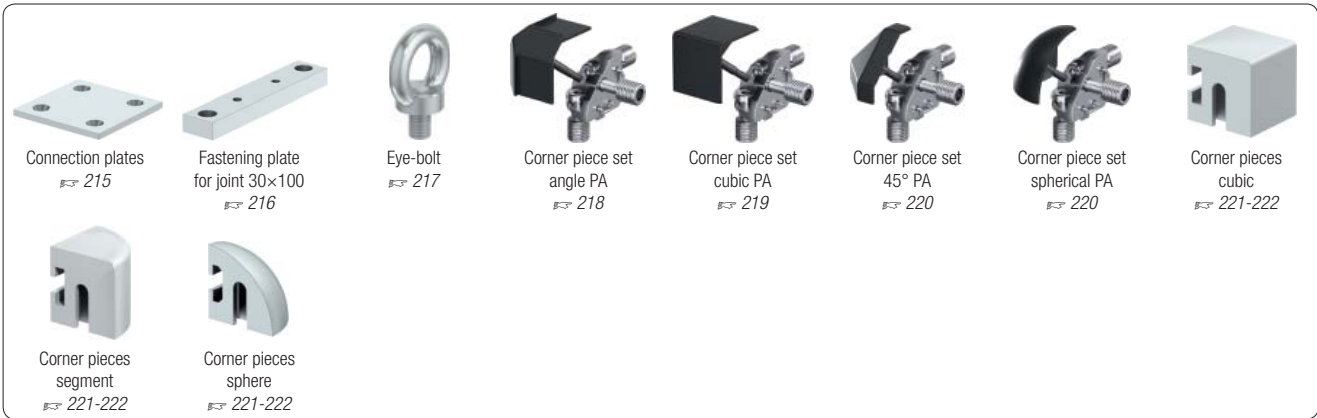

1.5 Pneumatic accessories



1.6 Additional accessories



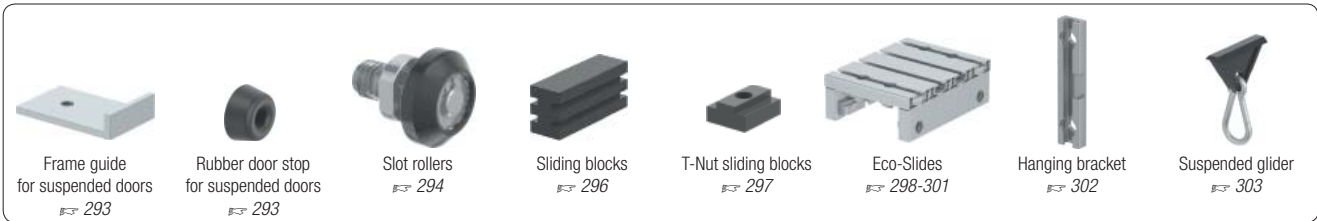

1.7 Electrical accessories

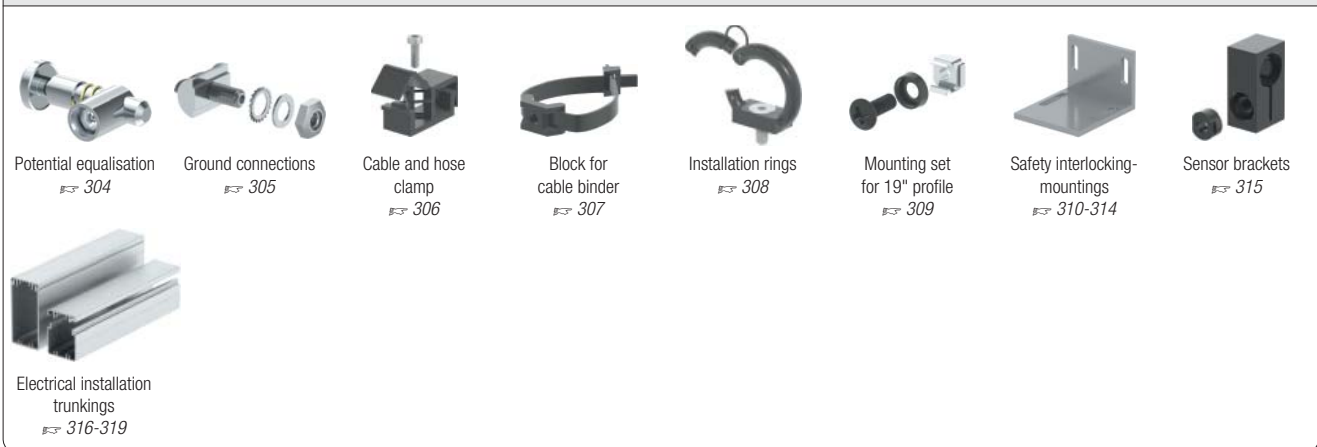



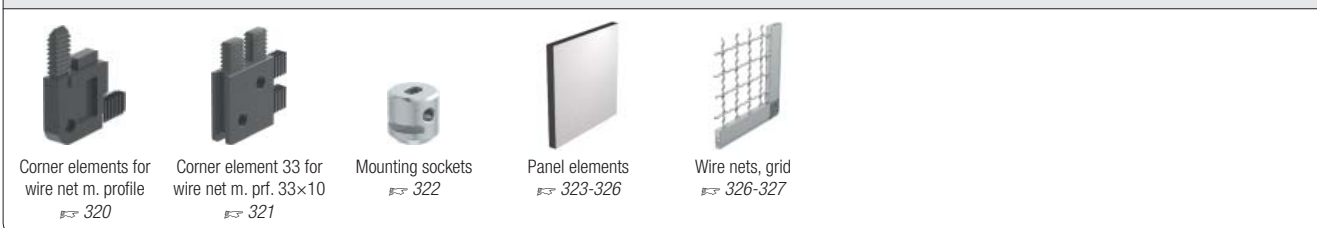





1.8 Panel elements

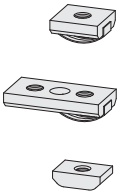

1.9 Tools

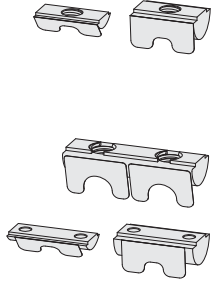

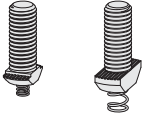

Description	H-slot		F-slot		E-slot		Assembly from end    from frontally		Fixation	Thread	Article-No. for fastening element for						
	H-slot		F-slot		E-slot		steel				VA		steel		VA		
	steel		VA		steel		VA				steel		VA				
Threaded plates 							●		leaf spring	M3	1.31.HM3		1.31.FM3		1.31.EM3		142
										M4	1.31.HM4		1.31.FM4		1.31.EM4		
										M5	1.31.HM5		1.31.FM5		1.31.EM5		
										M6			1.31.FM6		1.31.EM6		
										M8					1.31.EM8		
- for subsequent insertion								●	-	M3	1.31.4HM3						143
- heavy 							●		leaf spring	M6				1.31.6EM6		144	
										M8				1.31.6EM8			
							●		leaf spring	2×M6				1.31.6E2M6			
										2×M8				1.31.6E2M8			
T-Nuts - with spring 							●		leaf spring	M6		1.32.FM6		1.32.EM6		145	
										M8		1.32.FM8		1.32.EM8			
- for subs. insertion, with spring ball								●	spring ball	M4				1.32.3EM4		146	
									M5				1.32.3EM5				
									M6				1.32.3EM6				
									M8				1.32.3EM8				
- for subs. insertion, with spring 								●	leaf spring	M3		1.32.4FM3		1.32.4EM3		147	
										M4		1.32.4FM4		1.32.4EM4	V		
										M5		1.32.4FM5		1.32.4EM5	V		
										M6		1.32.4FM6	V	1.32.4EM6	V		
										M8		1.32.4FM7	V	1.32.4EM8	V		
						●		leaf spring	2×M8					1.32.4E2M8.41			
						●		leaf spring	2×M4			1.32.4F2M4.25		1.32.4E2M4.25		148	
Spring-nuts 							●		compressing spring	M3		1.33.FM3		1.33.EM3		149	
										M4		1.33.FM4		1.33.EM4			
										M5		1.33.FM5		1.33.EM5			
										M6		1.33.FM6		1.33.EM6			
T-slot nuts 								●	-	M4		1.34.10FM4		1.34.10EM4		150	
										M5		1.34.10FM5		1.34.10EM5			
										M6		1.34.10FM6		1.34.10EM6			
Rhomboid T-slot nuts 								●	self-locking	M3				1.34.20EM3		151	
										M4				1.34.20EM4			
										M5				1.34.20EM5			
										M6				1.34.20EM6			
T-Bolts 								●	compressing spring	M6×20		1.34.FM62		1.34.EM62		152	
										×30		1.34.FM63		1.34.EM63			
										M8×20		1.34.FM82		1.34.EM82			
										×25				1.34.EM825			
										×30		1.34.FM83		1.34.EM83			
									×40				1.34.EM84				

VA = stainless steel 1.4305

Threaded plates

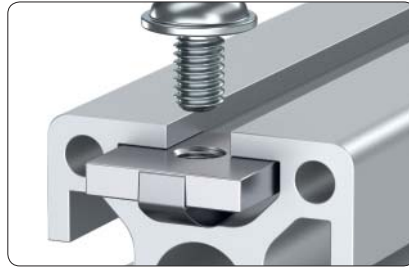

Fixed into position with leaf spring

Application

Fastening element for screw-type connections

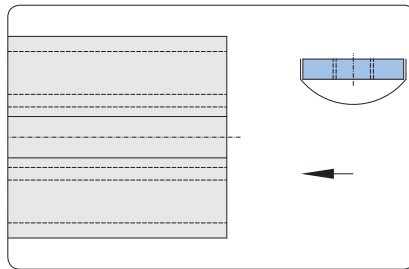

Assembly

Insert from end

Technical data

material: steel  
 surface: galvanised  
 max. moment of torque:  $M_{A, max}$

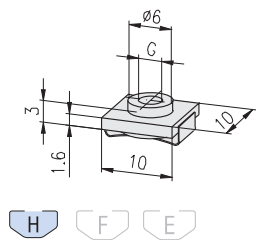

Description	G	$M_{A, max}$	Weight	Article-No.
Threaded plate H	M3	1.3 Nm	1.5 g	1.31.HM3
Threaded plate H	M4	2.0 Nm	1.3 g	1.31.HM4
Threaded plate H	M5	2.0 Nm	1.2 g	1.31.HM5

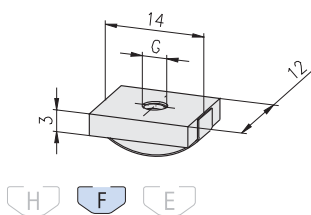

Description	G	$M_{A, max}$	Weight	Article-No.
Threaded plate F	M3	1.3 Nm	3.9 g	1.31.FM3
Threaded plate F	M4	3.0 Nm	3.7 g	1.31.FM4
Threaded plate F	M5	5.0 Nm	3.6 g	1.31.FM5
Threaded plate F	M6	7.0 Nm	3.3 g	1.31.FM6

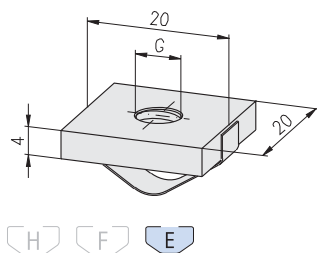

Description	G	$M_{A, max}$	Weight	Article-No.
Threaded plate E	M3	1.3 Nm	12.0 g	1.31.EM3
Threaded plate E	M4	3.0 Nm	11.8 g	1.31.EM4
Threaded plate E	M5	5.0 Nm	11.6 g	1.31.EM5
Threaded plate E	M6	8.0 Nm	11.3 g	1.31.EM6
Threaded plate E	M8	15.0 Nm	11.0 g	1.31.EM8

**Threaded plates  
for subsequent insertion**



**Application**

Fastening element for screw-type connections

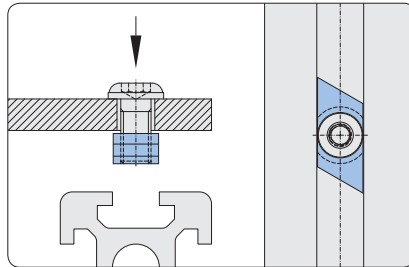

**Assembly**

Insert frontally

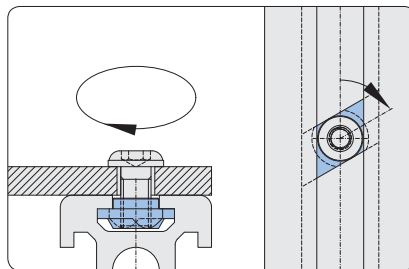

turn 60°

**Technical data**

material: steel  
 surface: galvanised  
 max. moment of torque:  $M_{A, \max}$

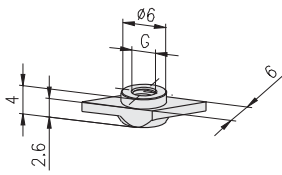

Description	G	$M_{A, \max}$	Weight	Article-No.
Threaded plate for subsequent insertion H	M3	1.3 Nm	0.90 g	1.31.4HM3
Threaded plate for subsequent insertion H	M4	2.0 Nm	0.85 g	1.31.4HM4
Threaded plate for subsequent insertion H	M5	2.0 Nm	0.80 g	1.31.4HM5



Threaded plates  
heavy

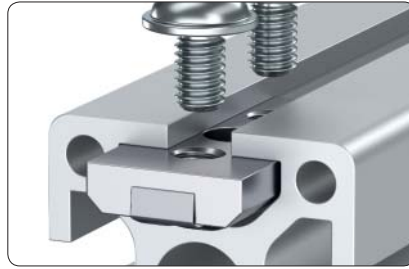

Fixed into position with leaf spring

Application

- Fastening element for
- screw-type connections
  - hinges, heavy, type 20, 21, 22, 23, 31

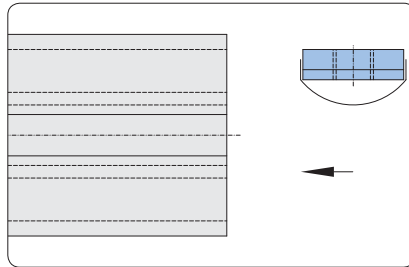

Assembly

Insert from end

Technical data

material: steel  
 surface: galvanised  
 max. moment of torque:  $M_{A, max}$

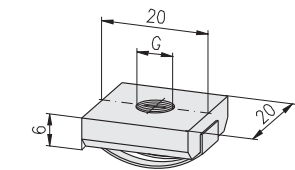

Description	G	$M_{A, max}$	Weight	Article-No.
Threaded plate, heavy E	M6	10.0 Nm	17.2 g	1.31.6EM6
Threaded plate, heavy E	M8	26.0 Nm	16.3 g	1.31.6EM8

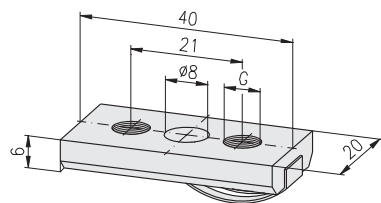

Description	G	$M_{A, max}$	Weight	Article-No.
Threaded plate, heavy E	2×M6	10.0 Nm	33.8 g	1.31.6E2M6
Threaded plate, heavy E	2×M8	26.0 Nm	32.0 g	1.31.6E2M8

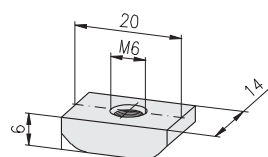

Application

Fastening element for ST-Connector  
 with anchor, screw-type ↗ 1.2D  
 Application sample ↗ Eco-Slide 1.67

Description	G	$M_{A, max}$	Weight	Article-No.
Threaded plate, heavy E	M6	10.0 Nm	12.4 g	1.31.7EM6

T-Nuts with spring

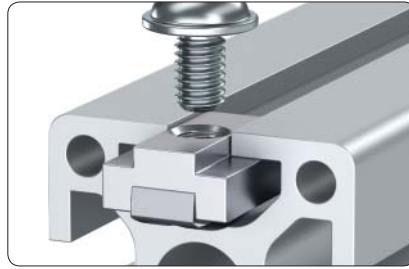

Fixing with leaf spring

Application

Fastening element for screw-type connections

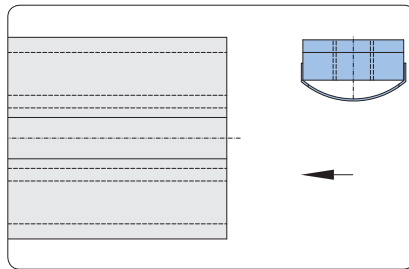

Assembly

Insert from end

Technical data

material: steel  
 surface: galvanised  
 max. moment of torque:  $M_{A, max}$

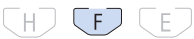
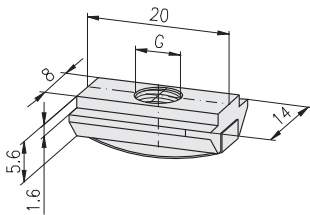

Description	G	$M_{A, max}$	Weight	Article-No.
T-Nut with spring F	M6	10 Nm	7.0 g	1.32.FM6
T-Nut with spring F	M8	26 Nm	6.6 g	1.32.FM8

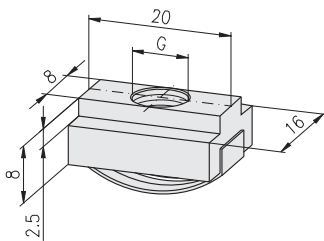

Description	G	$M_{A, max}$	Weight	Article-No.
T-Nut with spring E	M6	10 Nm	15 g	1.32.EM6
T-Nut with spring E	M8	26 Nm	14 g	1.32.EM8

**T-Nuts  
for subsequent insertion,  
with spring ball**

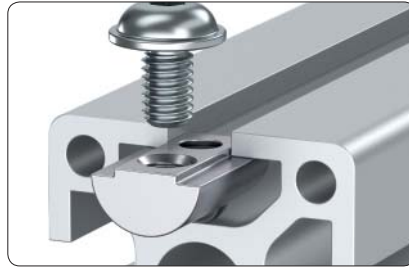

Fixing with spring ball

**Application**

Fastening element for screw-type connections

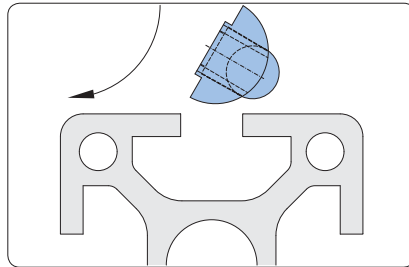

**Assembly**

Insert front-sided and rotate

**Technical data**

material: steel  
 surface: galvanised  
 max. moment of torque:  $M_{A, \max}$

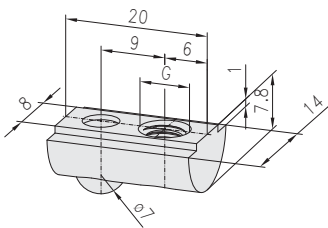

Description	G	$M_{A, \max}$	Weight	Article-No.
T-Nut for subs. insertion, w. spring ball E	M4	3.0 Nm	10.4 g	1.32.3EM4
T-Nut for subs. insertion, w. spring ball E	M5	5.0 Nm	10.2 g	1.32.3EM5
T-Nut for subs. insertion, w. spring ball E	M6	10.0 Nm	9.9 g	1.32.3EM6
T-Nut for subs. insertion, w. spring ball E	M8	26.0 Nm	9.6 g	1.32.3EM8

**T-Nuts for subsequent insertion, with spring**



Fixing with leaf spring

**Application**

Fastening element for screw-type connections

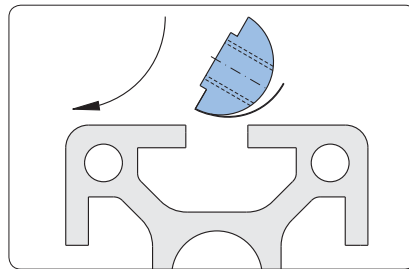

Insert front-sided and rotate

**Technical data**

Design steel:

- material: steel
- surface: galvanised

Design stainless:

- material: stainless steel 1.4305
- surface: pickled and passivated

max. moment of torque:  $M_{A, max}$

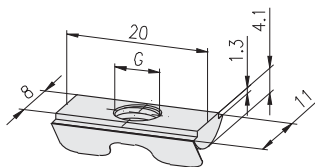

Description	G	Design	$M_{A, max}$	Weight	Article-No.
T-Nut for subs. ins., w. spring F	M3	steel	1.3 Nm	5.0 g	1.32.4FM3
T-Nut for subs. ins., w. spring F	M4	steel	3.0 Nm	4.9 g	1.32.4FM4
T-Nut for subs. ins., w. spring F	M5	steel	5.0 Nm	4.6 g	1.32.4FM5
T-Nut for subs. ins., w. spring F	M6	steel	10.0 Nm	4.3 g	1.32.4FM6
T-Nut for subs. ins., w. spring F	M8	steel	10.0 Nm	3.7 g	1.32.4FM8
T-Nut for subs. ins., w. spring F	M6	stainless	10.0 Nm	4.3 g	1.32.4FM6V
T-Nut for subs. ins., w. spring F	M8	stainless	10.0 Nm	3.7 g	1.32.4FM8V

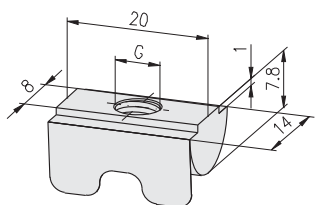

Description	G	Design	$M_{A, max}$	Weight	Article-No.
T-Nut for subs. ins., w. spring E	M3	steel	1.3 Nm	10.0 g	1.32.4EM3
T-Nut for subs. ins., w. spring E	M4	steel	3.0 Nm	10.0 g	1.32.4EM4
T-Nut for subs. ins., w. spring E	M5	steel	5.0 Nm	10.0 g	1.32.4EM5
T-Nut for subs. ins., w. spring E	M6	steel	10.0 Nm	10.0 g	1.32.4EM6
T-Nut for subs. ins., w. spring E	M8	steel	26.0 Nm	9.0 g	1.32.4EM8
T-Nut for subs. ins., w. spring E	M4	stainless	3.0 Nm	10.0 g	1.32.4EM4V
T-Nut for subs. ins., w. spring E	M5	stainless	5.0 Nm	10.0 g	1.32.4EM5V
T-Nut for subs. ins., w. spring E	M6	stainless	10.0 Nm	10.0 g	1.32.4EM6V
T-Nut for subs. ins., w. spring E	M8	stainless	26.0 Nm	9.0 g	1.32.4EM8V

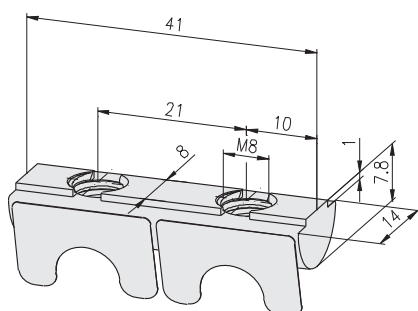

Fixing with leaf spring

**Application**

- Fastening element for
- screw-type connections
  - hinges, heavy, type 20, 21, 31

**Technical data**

material: steel  
 surface: galvanised  
 max. moment of torque:  $M_{A, max}$

Description	G	$M_{A, max}$	Weight	Article-No.
T-Nut for subs. ins., w. spring E	2×M8	26.0 Nm	20.3 g	1.32.4E2M8.41

3

**T-Nuts for subsequent insertion, with spring**



Fixing with leaf spring

**Application**

Fastening element for screw-type connections

**Technical data**

material: steel  
 surface: galvanised  
 max. moment of torque:  $M_{A, \max}$

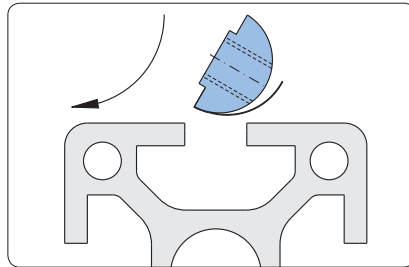

**Assembly**

Insert front-sided and rotate

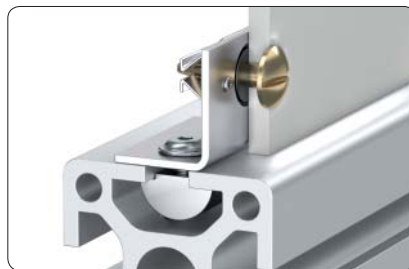

**Application**

Fastening element for mounting angle, quick lock  $\rightarrow$  265

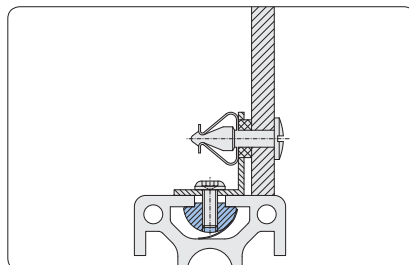

Fastening without washer

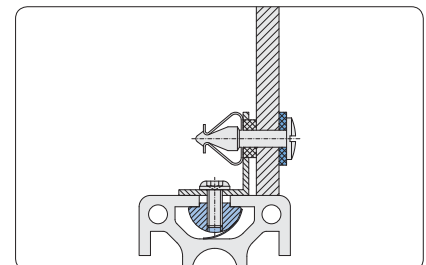

Fastening with washer

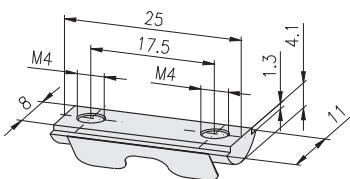

Description	G	$M_{A, \max}$	Weight	Article-No.
T-Nut for subs. ins., w. spring F	2×M4	3.0 Nm	7.0 g	1.32.4F2M4.25

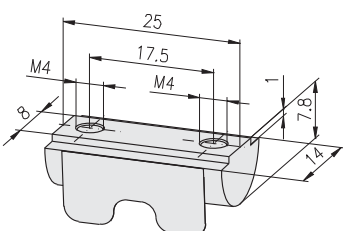

Description	G	$M_{A, \max}$	Weight	Article-No.
T-Nut for subs. ins., w. spring E	2×M4	3.0 Nm	12.0 g	1.32.4E2M4.25

Spring-nuts  
front-sided insertion

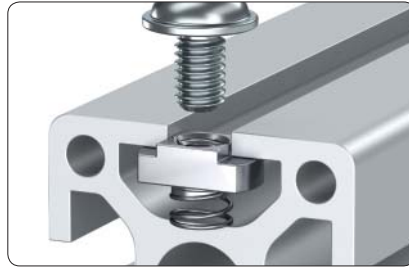

Fixing with compressing spring

Application

Fastening element for screw-type connections  
Applicable for small loads such as:

- enclosures
- electric switches

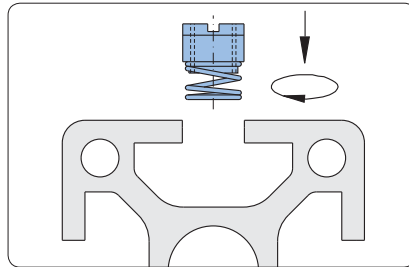

Assembly

Insert front-sided and turn 90°

Technical data

material: steel  
surface: galvanised  
max. moment of torque:  $M_{A, max}$

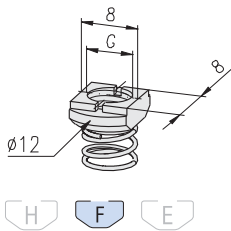

Description	G	$M_{A, max}$	Weight	Article-No.
Spring-nut F	M3	1.3 Nm	1.6 g	1.33.FM3
Spring-nut F	M4	3.0 Nm	1.5 g	1.33.FM4
Spring-nut F	M5	5.0 Nm	1.3 g	1.33.FM5
Spring-nut F	M6	8.0 Nm	1.1 g	1.33.FM6

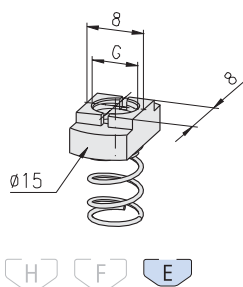

Description	G	$M_{A, max}$	Weight	Article-No.
Spring-nut E	M3	1.3 Nm	3.9 g	1.33.EM3
Spring-nut E	M4	3.0 Nm	3.7 g	1.33.EM4
Spring-nut E	M5	5.0 Nm	3.4 g	1.33.EM5
Spring-nut E	M6	10.0 Nm	3.0 g	1.33.EM6

T-slot nuts

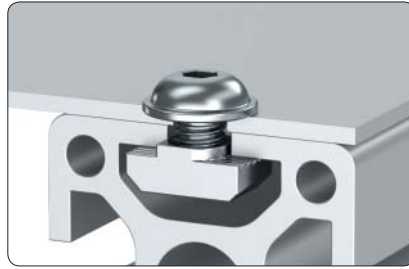

Application

Fastening element for screw-type connections

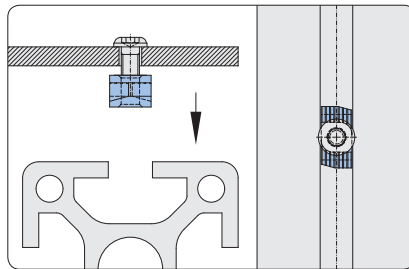

Assembly

Mount the T-slot nut onto the screw and insert into the slot

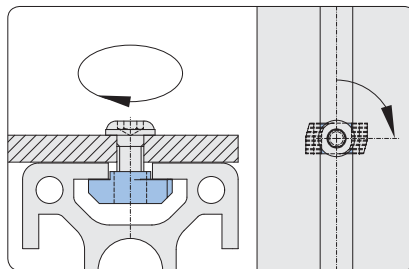

Rotate the screw with T-slot nut 90° inside and then fasten

Technical data

material: GD-Zn  
 surface: galvanised  
 max. moment of torque:  $M_{A, max}$

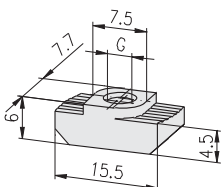
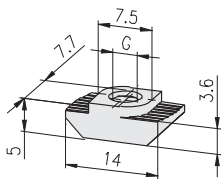

Description	G	$M_{A, max}$	Weight	Article-No.
T-slot nut F	M4	3.0 Nm	2.4 g	1.34.10FM4
T-slot nut F	M5	5.0 Nm	2.0 g	1.34.10FM5
T-slot nut F	M6	10.0 Nm	1.7 g	1.34.10FM6

Description	G	$M_{A, max}$	Weight	Article-No.
T-slot nut E	M4	3.0 Nm	3.6 g	1.34.10EM4
T-slot nut E	M5	5.0 Nm	3.2 g	1.34.10EM5
T-slot nut E	M6	10.0 Nm	3.0 g	1.34.10EM6

**Rhomboid T-slot nuts with self-locking**

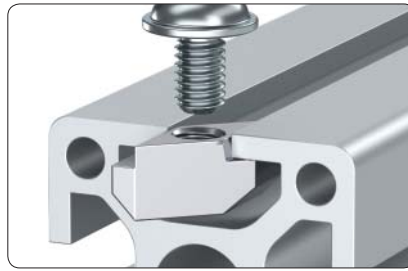

**Application**

For pre-assembly of threads in the profile slot

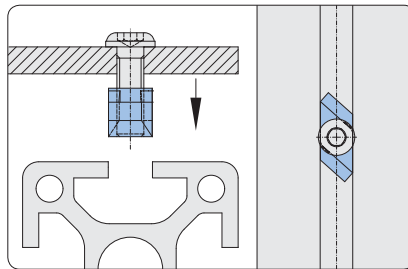

**Assembly**

Pre-assemble the rhomboid T-slot nut onto the screw, and insert into the slot

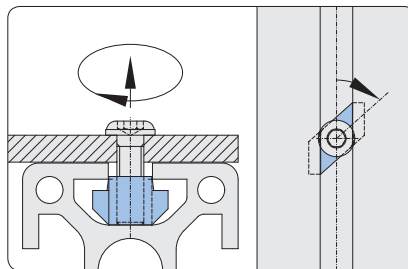

By tightening the screw, the rhomboid T-slot nut is turned 50° and jammed inside the slot with its conical flanks

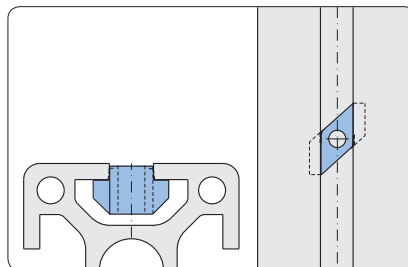

Even after loosening the screw, the rhomboid T-slot nut will remain wedged in place

**Technical data**

material: GD-Zn  
 surface: galvanised  
 max. moment of torque:  $M_{A, max}$

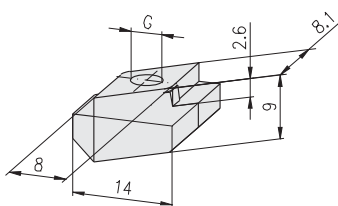

Description	G	$M_{A, max}$	Weight	Article-No.
Rhomboid T-slot nut E	M3	1.3 Nm	6.5 g	1.34.20EM3
Rhomboid T-slot nut E	M4	3.0 Nm	6.2 g	1.34.20EM4
Rhomboid T-slot nut E	M5	5.0 Nm	5.9 g	1.34.20EM5
Rhomboid T-slot nut E	M6	10.0 Nm	5.5 g	1.34.20EM6



**T-Bolts  
front-sided insertion**

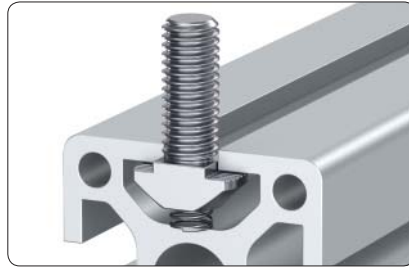

Fixing with compressing spring

**Application**

Fastening element for screw-type connections

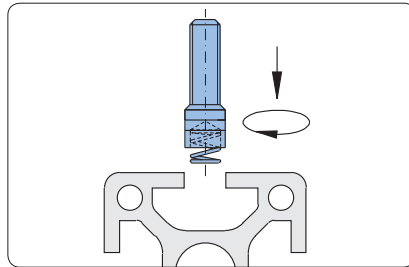

**Assembly**

Insert front-sided and turn 90°

**Technical data**

material: steel  
 surface: galvanised  
 max. moment of torque:  $M_{A, \max}$

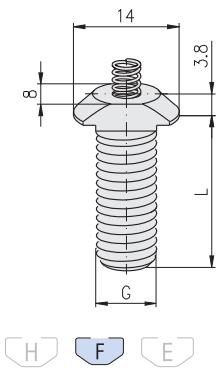

Description	G×L	$M_{A, \max}$	Weight	Article-No.
T-Bolt F	M6×20	6 Nm	6.0 g	1.34.FM62
T-Bolt F	M6×30	6 Nm	7.0 g	1.34.FM63
T-Bolt F	M8×20	15 Nm	8.0 g	1.34.FM82
T-Bolt F	M8×30	15 Nm	11.2 g	1.34.FM83

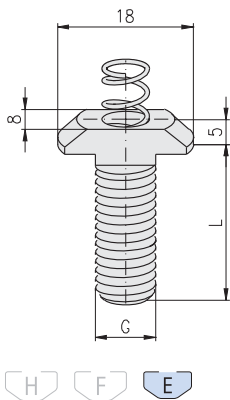

Description	G×L	$M_{A, \max}$	Weight	Article-No.
T-Bolt E	M6×20	6 Nm	9.0 g	1.34.EM62
T-Bolt E	M6×30	6 Nm	10.0 g	1.34.EM63
T-Bolt E	M8×20	18 Nm	12.0 g	1.34.EM82
T-Bolt E	M8×25	18 Nm	13.0 g	1.34.EM825
T-Bolt E	M8×30	18 Nm	14.0 g	1.34.EM83
T-Bolt E	M8×40	18 Nm	18.0 g	1.34.EM84

Threaded inserts  
for core hole Ø6

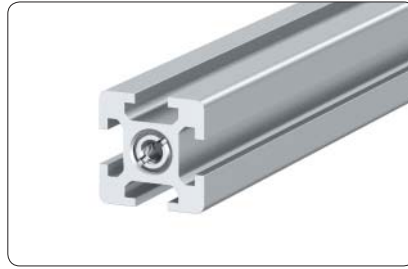

Application

For mounting on front end and fastening of any profile with core hole Ø6

Technical data

material: steel  
surface: galvanised

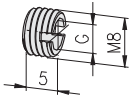

Description	G	Weight	Article-No.
Threaded insert	M8/M4	1.0 g	1.35.10804
Threaded insert	M8/M5	0.9 g	1.35.10805

for core hole Ø12

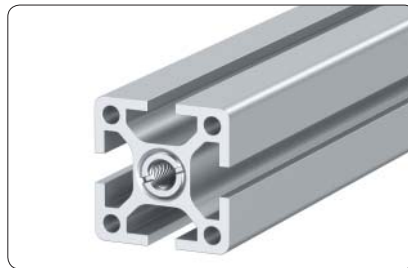

Application

For mounting on front end and fastening of any profile with core hole Ø12

Technical data

material: steel  
surface: galvanised

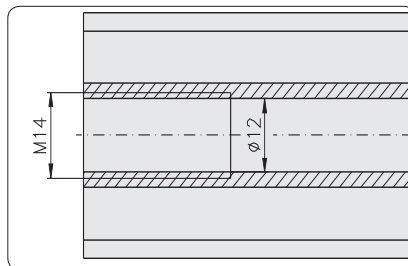

Assembly preparation for threaded insert M14/Mxx

- Tap M14 thread in core hole Ø12 mm

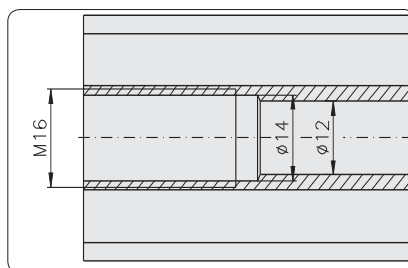

1) Assembly preparation for threaded insert M16/M12

- Drill Ø12 mm core hole to 14 mm
- Tap M16 thread in core hole Ø14 mm

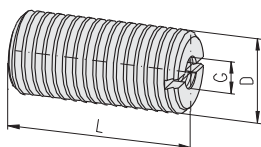

Description	D/G	L	Weight	Article-No.
Threaded insert	M14/M6	15	11 g	1.35.1140615
Threaded insert	M14/M6	30	22 g	1.35.1140630
Threaded insert	M14/M8	15	9 g	1.35.1140815
Threaded insert	M14/M8	30	18 g	1.35.1140830
Threaded insert	M14/M10	15	6 g	1.35.1141015
Threaded insert	M14/M10	30	12 g	1.35.1141030
1) Threaded insert	M16/M12	15	8 g	1.35.1161215
1) Threaded insert	M16/M12	30	16 g	1.35.1161230

**Threaded inserts  
for outer chambers PG 50, heavy**

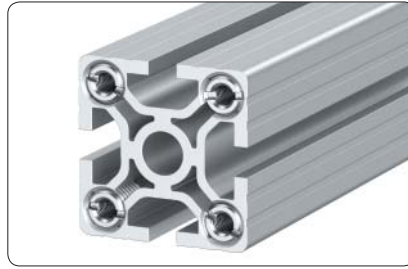

**Application**

For mounting on front end via the outer chambers PG 50, heavy

**Technical data**

material: steel  
surface: galvanised

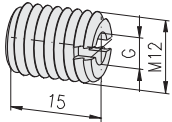

16 20 30 40 45 50 60

Description	G	Weight	Article-No.
Threaded insert	M12/M4	8.6 g	1.35.11204
Threaded insert	M12/M5	8.0 g	1.35.11205
Threaded insert	M12/M6	7.3 g	1.35.11206
Threaded insert	M12/M8	5.5 g	1.35.11208

**for outer chambers PG 60**

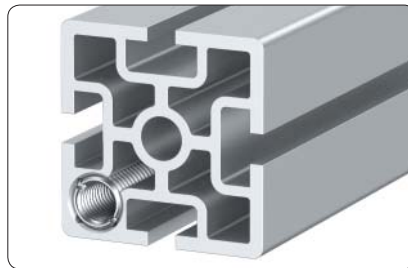

**Application**

For mounting on front end via the outer chambers PG 60

**Technical data**

material: steel  
surface: galvanised

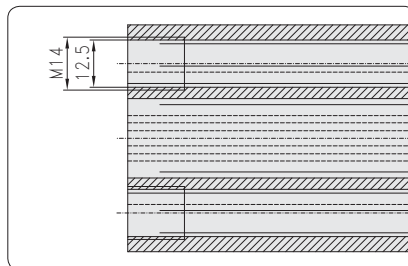

**Assembly preparation for threaded insert M14/Mxx**

- Tap M14 thread in outer chamber

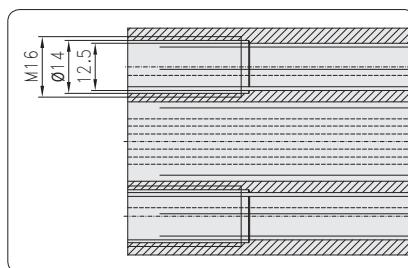

**1) Assembly preparation for threaded insert M16/M12**

- Drill Ø12 mm outer chamber to 14 mm
- Tap M16 thread in borehole Ø14 mm

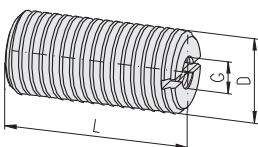

16 20 30 40 45 50 60

Description	D/G	L	Weight	Article-No.
Threaded insert	M14/M6	15	11 g	1.35.1140615
Threaded insert	M14/M6	30	22 g	1.35.1140630
Threaded insert	M14/M8	15	9 g	1.35.1140815
Threaded insert	M14/M8	30	18 g	1.35.1140830
Threaded insert	M14/M10	15	6 g	1.35.1141015
Threaded insert	M14/M10	30	12 g	1.35.1141030
1) Threaded insert	M16/M12	15	8 g	1.35.1161215
1) Threaded insert	M16/M12	30	16 g	1.35.1161230

Press-fit threaded inserts  
for core hole Ø12

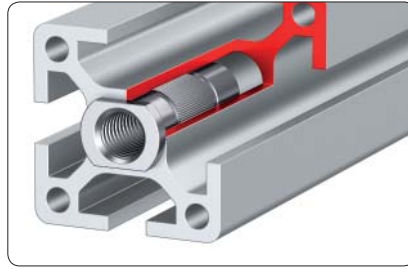

**Application**

For mounting on front end and fastening of any profile with core hole Ø12

**Technical data**

material: steel  
surface: galvanised

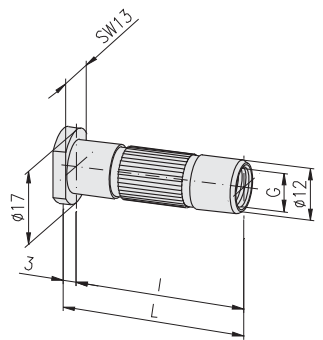

- 16
- 20
- 30
- 40
- 45
- 50
- 60

Description	G	L	I	Weight	Article-No.
Press-fit threaded insert	Ø12/M8	22.5	19.5	15 g	1.35.608195
Press-fit threaded insert	Ø12/M8	32.5	29.5	20 g	1.35.608295
Press-fit threaded insert	Ø12/M8	42.5	39.5	26 g	1.35.608395
Press-fit threaded insert	Ø12/M8	47.5	44.5	28 g	1.35.608445
Press-fit threaded insert	Ø12/M8	52.5	49.5	31 g	1.35.608495
Press-fit threaded insert	Ø12/M10	22.5	19.5	11 g	1.35.610195
Press-fit threaded insert	Ø12/M10	32.5	29.5	15 g	1.35.610295
Press-fit threaded insert	Ø12/M10	42.5	39.5	18 g	1.35.610395
Press-fit threaded insert	Ø12/M10	47.5	43.5	20 g	1.35.610445
Press-fit threaded insert	Ø12/M10	52.5	49.5	22 g	1.35.610495

Press-fit threaded inserts  
w/o collar  
for core hole Ø12

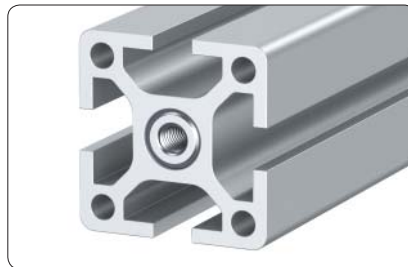

**Application**

For mounting on front end and fastening of any profile with core hole Ø12

**Technical data**

material: steel  
surface: galvanised

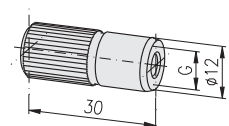

- 16
- 20
- 30
- 40
- 45
- 50
- 60

Description	G	Weight	Article-No.
Press-fit threaded insert, w/o collar	Ø12/M6	19 g	1.35.606300
Press-fit threaded insert, w/o collar	Ø12/M8	17 g	1.35.608300

**Press-fit threaded inserts  
for screw connections across the  
profile**

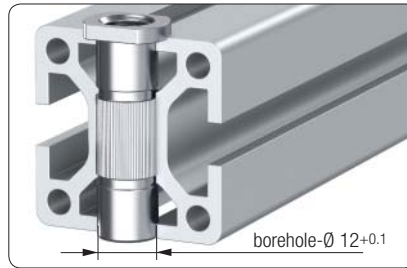

**Application**

For screw connections across the profile;  
for cross section of  
20 mm / 30 mm / 40 mm / 45 mm / 50 mm

**Technical data**

material: steel  
surface: galvanised

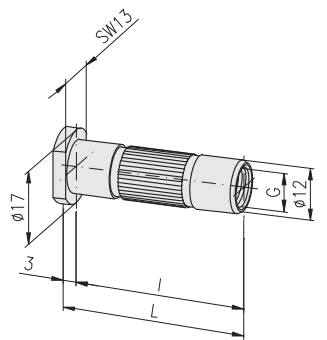

- 16 20 30 40 45 50 60

Description	G	L	I	Weight	Article-No.
Press-fit threaded insert	Ø12/M8	22.5	19.5	15 g	1.35.608195
Press-fit threaded insert	Ø12/M8	32.5	29.5	20 g	1.35.608295
Press-fit threaded insert	Ø12/M8	42.5	39.5	26 g	1.35.608395
Press-fit threaded insert	Ø12/M8	47.5	44.5	28 g	1.35.608445
Press-fit threaded insert	Ø12/M8	52.5	49.5	31 g	1.35.608495
Press-fit threaded insert	Ø12/M10	22.5	19.5	11 g	1.35.610195
Press-fit threaded insert	Ø12/M10	32.5	29.5	15 g	1.35.610295
Press-fit threaded insert	Ø12/M10	42.5	39.5	18 g	1.35.610395
Press-fit threaded insert	Ø12/M10	47.5	43.5	20 g	1.35.610445
Press-fit threaded insert	Ø12/M10	52.5	49.5	22 g	1.35.610495

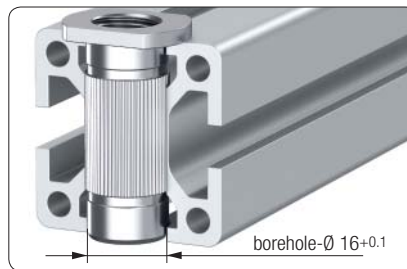

**Application**

For screw connections across the profile for  
cross section of  
30 mm / 40 mm / 45 mm / 50 mm

**Technical data**

material: steel  
surface: galvanised

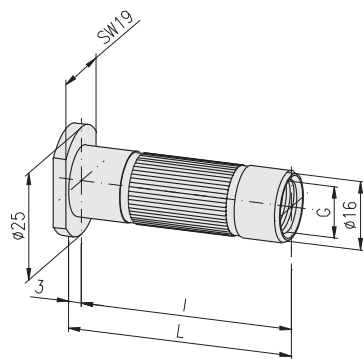

- 16 20 30 40 45 50 60

Description	G	L	I	Weight	Article-No.
Press-fit threaded insert	Ø16/M14	32.5	29.5	25 g	1.35.614295
Press-fit threaded insert	Ø16/M14	42.5	39.5	30 g	1.35.614395
Press-fit threaded insert	Ø16/M14	47.5	44.5	32 g	1.35.614445
Press-fit threaded insert	Ø16/M14	52.5	49.5	35 g	1.35.614495

Cover profiles

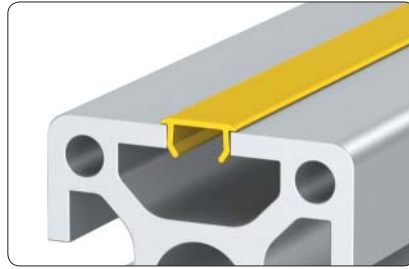

Application

Cover profile with 1.2 mm jutout for the protection of the profile slots

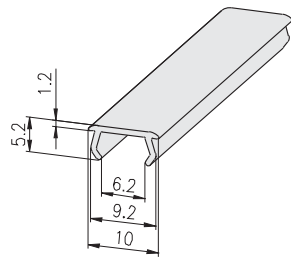

Technical data

- bar length: 2.5 m
- material: PVC rigid
- oil and water resistant
- anti-electrostatic
- lead- and cadmium free

Colours



Description	Colour	similar to RAL	Weight	Article-No.
Cover profile 10, PVC, F/E,	grey	7035	85 g/bar	1.41.11.1
Cover profile 10, PVC, F/E,	black	9011	85 g/bar	1.41.11.2
Cover profile 10, PVC, F/E,	yellow	1023	85 g/bar	1.41.11.3

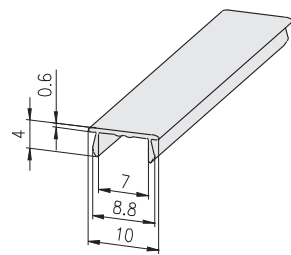

Technical data

- bar length: 2.5 m
- material: aluminium
- surface: natural anodised

Colour



Description	Weight	Article-No.
Cover profile 10, Alu, F/E	67.5 g/bar	1.41.121

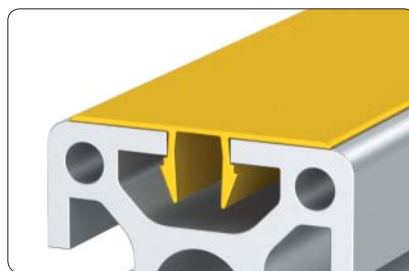

Application

Cover profile for the protection of the profile slots  
Dangerous spots can be marked with yellow cover profiles

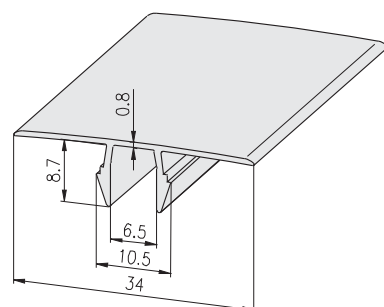

Technical data

- bar length: 2.5 m
- material: PVC rigid
- oil and water resistant

Colours



Description	Colour	similar to RAL	Weight	Article-No.
Cover profile 34, PVC, E,	grey	7035	170 g/bar	1.41.15E34.1
Cover profile 34, PVC, E,	black	9011	170 g/bar	1.41.15E34.2
Cover profile 34, PVC, E,	yellow	1003	204 g/bar	1.41.15E34.3

Sliding und cover profiles PVC

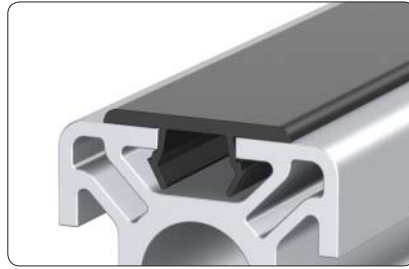

**Application**

For the protection of the profile slots;  
usable as a sliding element

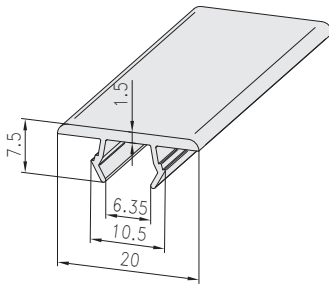

**Technical data**

bar length: 6.0 m  
material: HD PE Shore 100

- oil and water resistant
- anti-electrostatic
- lead- and cadmium free

**Colours**



Description	Colour	similar to RAL	Weight	Article-No.
Sliding and cover profile 20 PE, F/E3	black	9011	249 g/bar	1.41.16F/E320.2
Sliding and cover profile 20 PE, F/E3	grey/white	9002	249 g/bar	1.41.16F/E320.4

Reducing profiles PVC

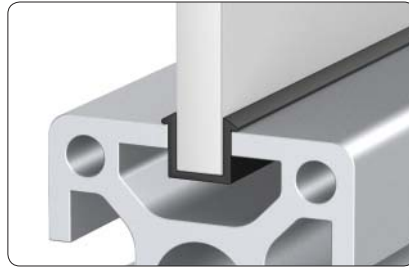

**Application**

To reduce the slot size from 8 mm to 6 mm

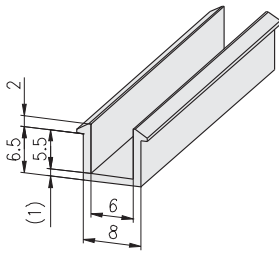

**Technical data**

- bar length: 2.5 m  
 material: PVC rigid
- oil and water resistant
  - anti-electrostatic
  - lead- and cadmium free

**Colours**



Description	Colour	similar to RAL	Weight	Article-No.
Reducing profile PVC, F/E, 8/6	grey	7035	85 g/bar	1.41.21.1
Reducing profile PVC, F/E, 8/6	black	9011	85 g/bar	1.41.21.2



Combination profiles PVC



Use as reduction profile



Use as slot-cover profile

**Application**

Combination profiles for use as reduction or cover profiles

**Technical data**

bar length: 2.5 m  
 material: PVC rigid  
 • oil and water resistant

**Colours**



grey

black

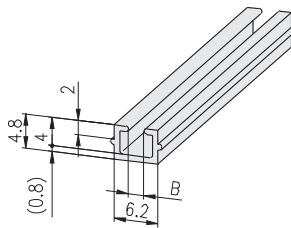

Description	B	Colour	similar to RAL	Weight	Article-No.
Combination profile PVC, H	2	grey	7035	37.5 g/bar	1.41.H02.1
Combination profile PVC, H	2	black	9011	37.5 g/bar	1.41.H02.2
Combination profile PVC, H	4	grey	7035	35.0 g/bar	1.41.H04.1
Combination profile PVC, H	4	black	9011	35.0 g/bar	1.41.H04.2

Combination profiles

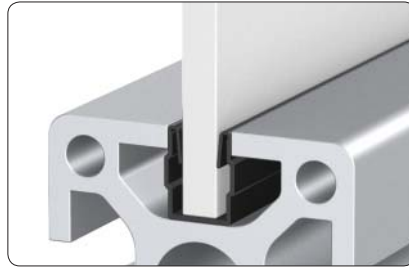

Use as reduction profile

**Application**

Combination profiles for use as reduction or cover profiles

**Technical data**

- bar length: 2.5 m
- material: PP
- oil and water resistant

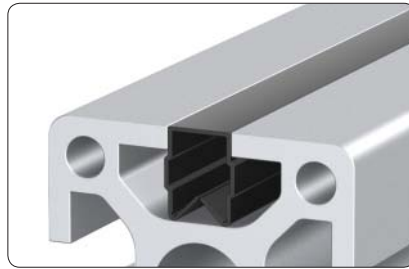

Use as slot-cover profile

**Colours**

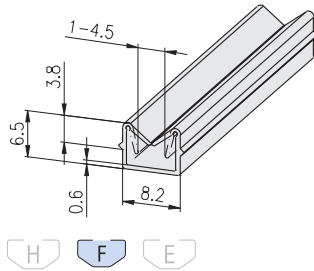

Description	D	Colour	similar to RAL	Weight	Article-No.
Combination profile F	1 - 4.5	grey	7035	31 g/bar	1.41.F14.1
Combination profile F	1 - 4.5	black	9011	31 g/bar	1.41.F14.2

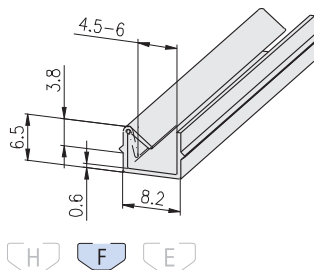

Description	D	Colour	similar to RAL	Weight	Article-No.
Combination profile F	4.5 - 6	grey	7035	28 g/bar	1.41.F46.1
Combination profile F	4.5 - 6	black	9011	28 g/bar	1.41.F46.2

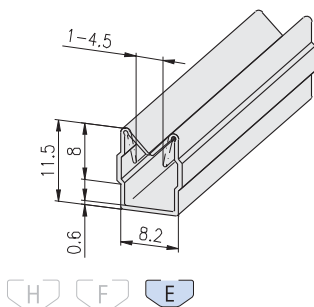

Description	D	Colour	similar to RAL	Weight	Article-No.
Combination profile E	1 - 4.5	grey	7035	47 g/bar	1.41.E314.1
Combination profile E	1 - 4.5	black	9011	47 g/bar	1.41.E314.2

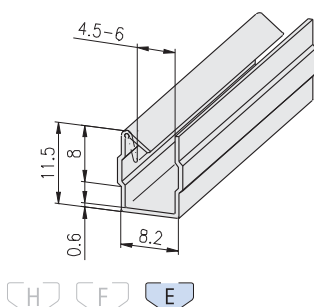

Description	D	Colour	similar to RAL	Weight	Article-No.
Combination profile E	4.5 - 6	grey	7035	42 g/bar	1.41.E346.1
Combination profile E	4.5 - 6	black	9011	42 g/bar	1.41.E346.2

Sliding doors  
construction types



Fixed

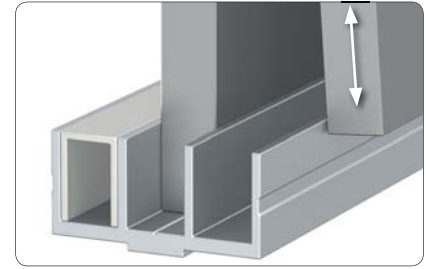

Removable

Profile	Sliding profile 30 mm			Sliding profile 50 mm	
	Fixed	Removable		Fixed	Removable
Type of mounting	Fixed	Removable		Fixed	Removable
Profile above	30×14	30×26	30×26	50×14	50×14
Profile below	30×14	30×14	30×26	50×14	50×14
Panel element 8 mm	 $H = A - 6$	 $H = A - 18$ $H1 = A - 44$	 $H = A - 30$ $H1 = A - 56$	 $H = A - 9$	 $H = A - 19$ $H1 = A - 45$
Panel element 6 mm	 $H = A - 8$	 $H = A - 19$ $H1 = A - 45$	 $H = A - 31$ $H1 = A - 57$	 $H = A - 9$	 $H = A - 19$ $H1 = A - 45$
Panel element 1 - 14 mm	 $H = A - 6$ $H1 = A - 58$	 $H = A - 18$ $H1 = A - 70$	 $H = A - 30$ $H1 = A - 82$	 $H = A - 17$ $H1 = A - 69$	 $H = A - 19$ $H1 = A - 71$

Combination profiles PVC

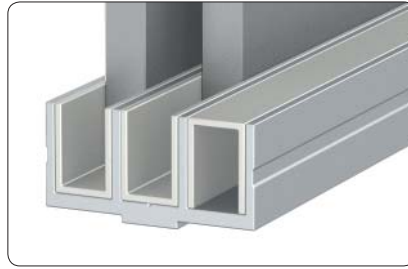

**Application**

Combination profiles for sliding profiles alternatively suitable as:

- reducing profile
- cover profile
- Inserted plate (only combination profile 1.41.330)

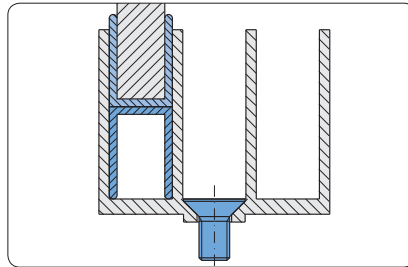

Inserted plate for sliding profile 30x26:  
combination profile 1.41.330

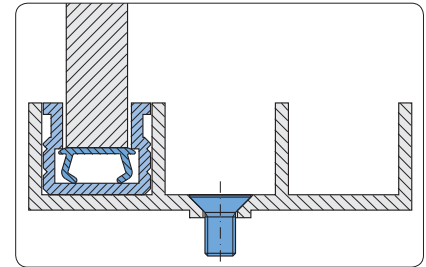

Inserted plate for sliding profile 50x14:  
for sliding profile 1.41.11.1, 1.41.11.2

**Technical data**

bar length: 2.5 m  
material: PVC rigid  
oil and water resistant

**Colour**

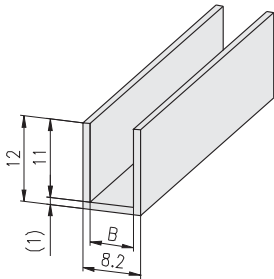

Description	B	Weight	Article-No.
Combination profile PVC for 30x14	6.2	115 g/bar	1.41.330

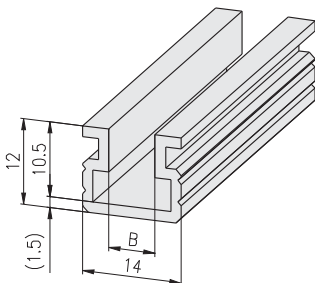

Description	B	Weight	Article-No.
Combination profile PVC for 50x14	6.5	222.5 g/bar	1.41.350
Combination profile PVC for 50x14	9.0	205.0 g/bar	1.41.351

Guide profile PVC

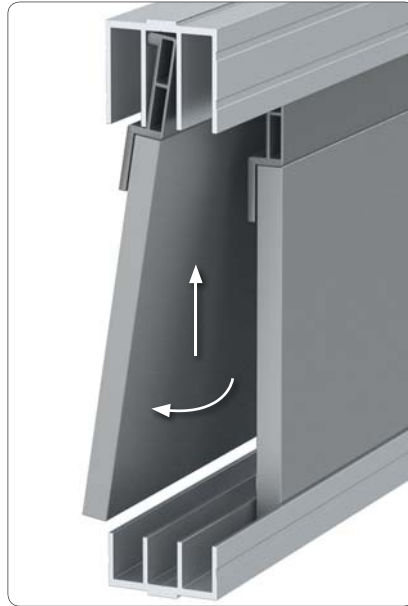

**Application**

- The guide profile is necessary
- for demountable sliding doors
  - for the use of panel elements of each plate thickness from 1 mm to 14 mm

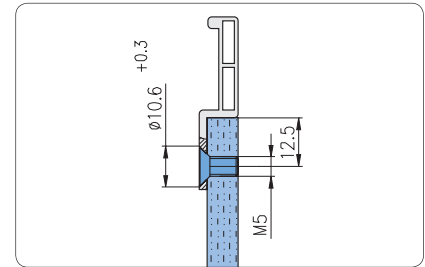

Drill dimensions

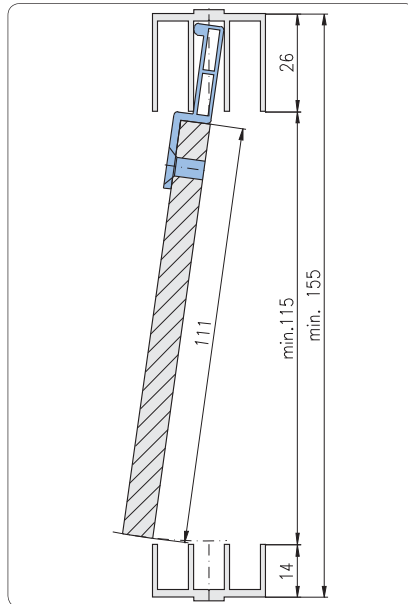

Minimum height for lifting of the panel elements

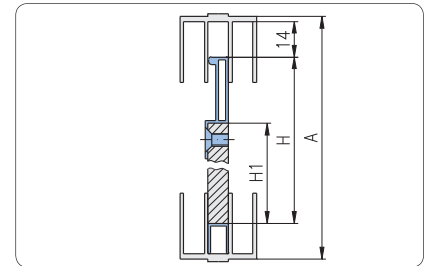

Use in sliding profile 30x26

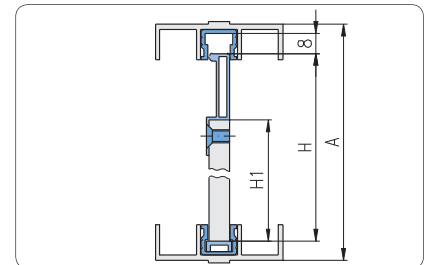

Use in sliding profile 50x14 with combination profile

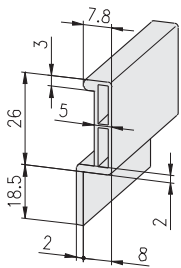

**Technical data**

bar length: 2.5 m  
 material: PVC rigid  
 oil and water resistant

**Colour**



**Description**

Guide profile PVC for sliding profile

**Weight**

375 g/bar

**Article-No.**

1.41.360

Framing profiles  
one piece

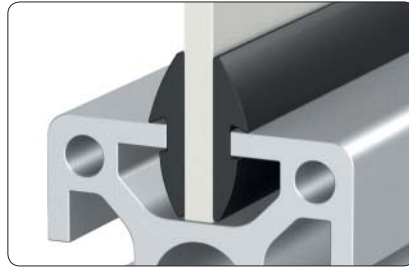

Application

The one piece framing profile for mounting panels of different thickness  
The elastic lips provide a good seal

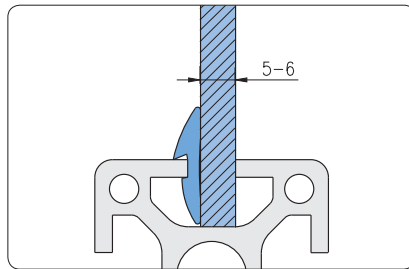

One sided application for profiles with F- and E-slots and panels 5 - 6 mm thick

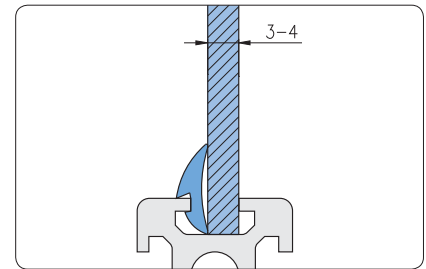

One sided application for profiles with H-slots and panels 3 - 4 mm thick

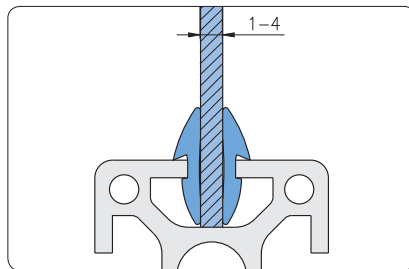

Two sided application for profiles with F- and E-slots and panels 1 - 4 mm thick

Colours

grey: similar to RAL 7035  
black: similar to RAL 9011

Technical data

length of ring: 60 m  
material: NBR - 60 Shore A  
• compatible with acrylic glass  
• oil and water resistant

Colours

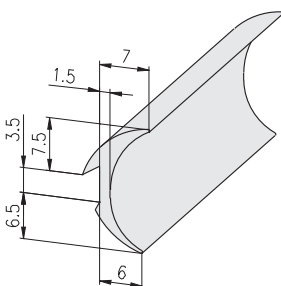
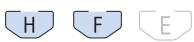
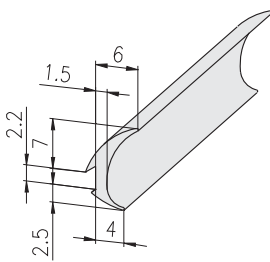

Description	Colour	similar to RAL	Weight	Article-No.
Framing profile one piece F	grey	7035	2,200 g/ring	1.41.5F0.1.60
			37 g/m	1.41.5F0.1-A00A00/...
Framing profile one piece F	black	9011	2,200 g/ring	1.41.5F0.2.60
			37 g/m	1.41.5F0.2-A00A00/...

/... = length in mm

Description	Colour	similar to RAL	Weight	Article-No.
Framing profile one piece E	grey	7035	3,120 g/ring	1.41.5E0.1.60
			52 g/m	1.41.5E0.1-A00A00/...
Framing profile one piece E	black	9011	3,120 g/ring	1.41.5E0.2.60
			52 g/m	1.41.5E0.2-A00A00/...

/... = length in mm

Wedge profiles

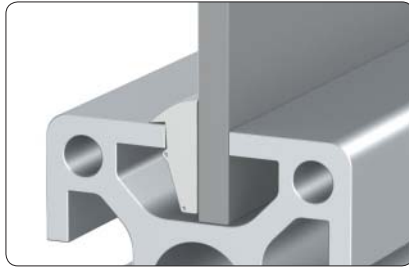

Application

Wedge profiles for sealing or fixing of panel elements with a thickness of 4 mm

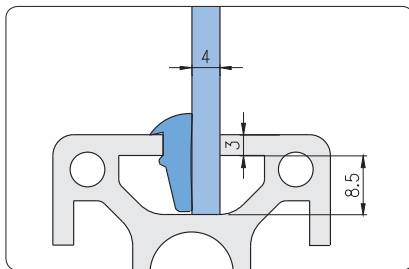
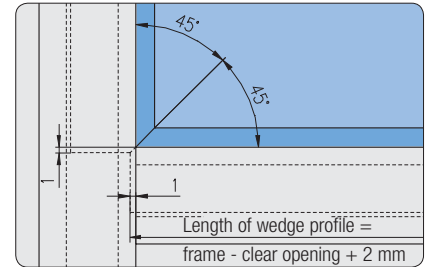
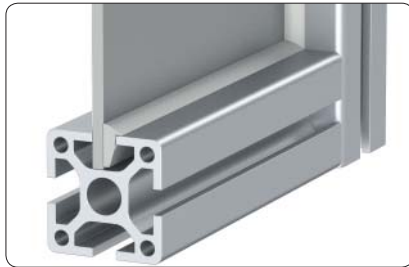

E3-slot

Technical data

- length of ring: 100 m
- material: Santoprene™
- free of silicon
- compatible with acrylic glass

Colour

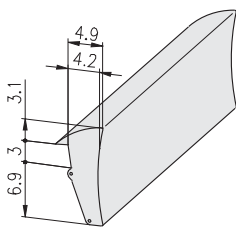

Description	Colour	Weight	Article-No.
Wedge profile E3	grey	5,000 g/ring	1.41.51E3.1.99
		50 g/m	1.41.51E3.1-A00A00/...

/... = length in mm

Sponge rubber round cords

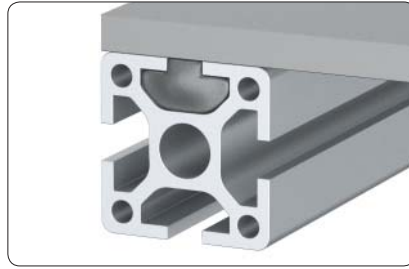

**Application**

Sponge rubber round cords for sealing

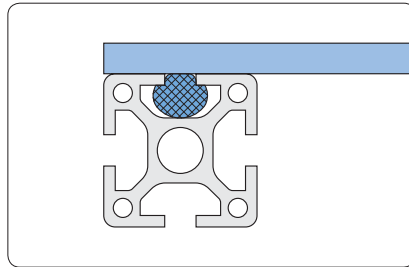

Profile with panel element

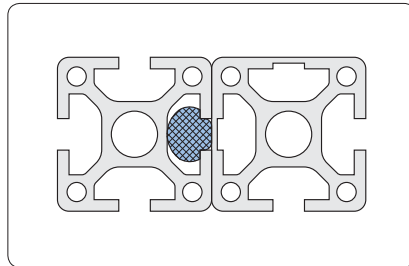

1 profile with slot  
1 profile closed

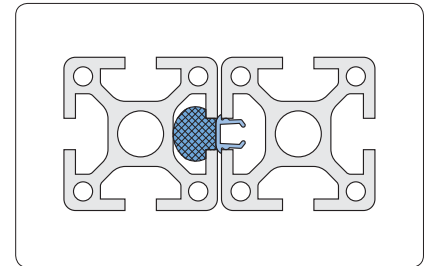

2 profiles with slots  
1 profile with slot-cover profile

Sponge rubber round cord diameter-determination	
Profile slot	Sponge rubber diameter
H-slot	8 mm
F-slot	12 mm
E-slot	18 mm



Sponge rubber round cords

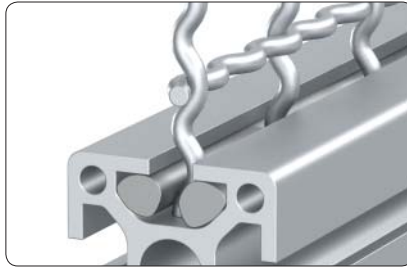

Application

For compensation of slot width on in-between sizes of cover panels

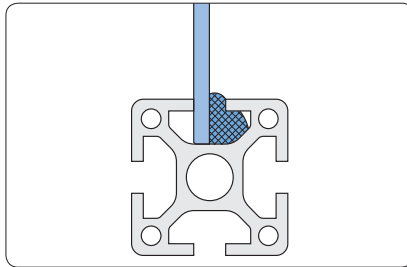

Enclosures with panel materials

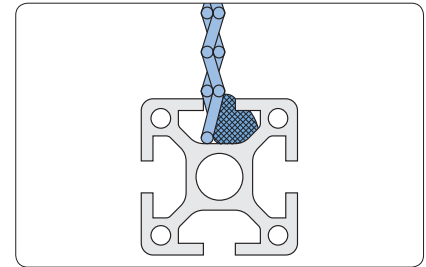

Enclosures with wire screens

Sponge rubber round cord diameter-determination		
Profile slot	Plate thickness	Sponge rubber diameter
H-slot	1 - 3 mm	6 mm
F-slot	1 - 2 mm	10 mm
	3 mm	8 mm
	4 - 5 mm	6 mm
E-slot	1 - 3 mm	10 mm
	3 - 4 mm	2×8 mm
	5 mm	2×6 mm

Technical data

length of ring: 100 m  
material: EPDM

Colour

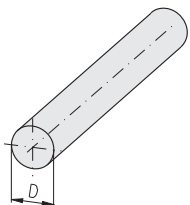

Description	D	Weight	Article-No.
Sponge rubber round cords	Ø6	1,100 g/ring	1.41.606.99
		11 g/m	1.41.606-A00A00/...
Sponge rubber round cords	Ø8	1,900 g/ring	1.41.608.99
		19 g/m	1.41.608-A00A00/...
Sponge rubber round cords	Ø10	3,200 g/ring	1.41.610.99
		32 g/m	1.41.610-A00A00/...
Sponge rubber round cords	Ø12	4,600 g/ring	1.41.612.99
		46 g/m	1.41.612-A00A00/...
Sponge rubber round cords	Ø18	10,000 g/ring	1.41.618.99
		100 g/m	1.41.618-A00A00/...

/... = length in mm

Sealing profile



Application

For sealing of doors and windows and for door stops

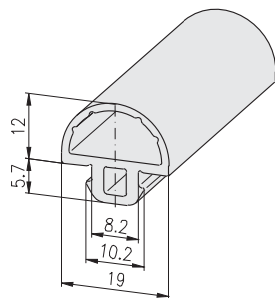
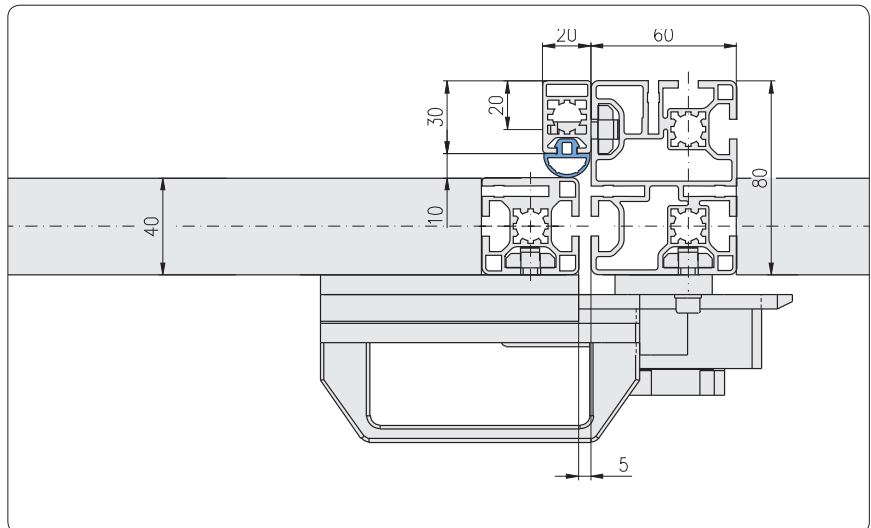

Technical data

length of ring: 40 m

material: EPDM, 60° ± 5° Shore A

- free of silicon
- compatible with acrylic glass

Colour



Description	Colour		Weight	Article-No.
Sealing profile F	black	ring	5,120 g/ring	1.41.6510F.2.40
			128 g/m	1.41.6510F.2-A00A00/...
/... = length in mm				

Framing profiles

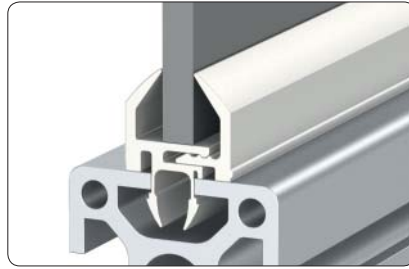

**Application**

The framing profile allows the installation of panels in closed frames

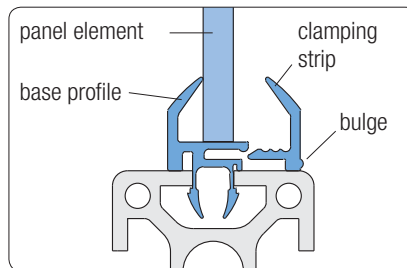

**Assembly**

1. Insert base profile in profile slot
2. Put panel element in position
3. Push clamping strip in position

**Comments**

The clamping strip is badged by a bulge as a distinctive mark to the base profile

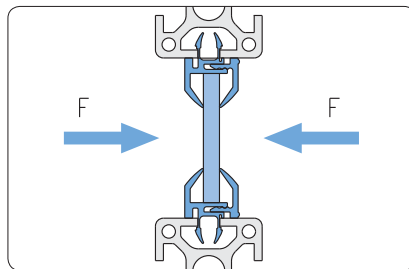

Maximum loading of framing profile:

$$F_{\max} = 200 \text{ N/m}$$

For maximum loading of element be aware of the stability of used framing profile

**Technical data**

bar length: 6 m

material:

- base body: PVC rigid, 98° Shore A
- lip: PVC soft, TPE 60° ± 5° Shore A, compatible with acrylic glass, free of silicon

temperature

range: -20°C to +80°C

**Colours**



grey

black

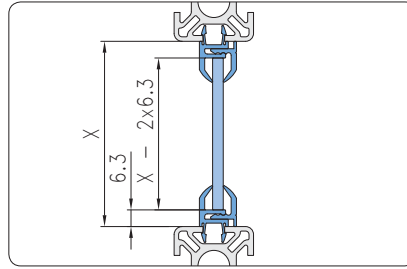
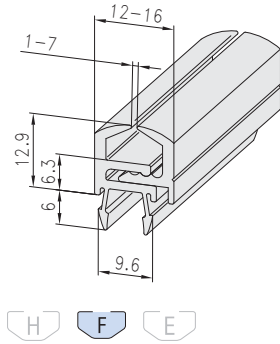

**Comments**

Suitable for panel elements from 1 to 7 mm thickness

Description	Colour	similar to RAL	Weight	Article-No.
Framing profile F	grey	7035	960 g/bar	1.41.71F0107.1.60
			160 g/m	1.41.71F0107.1-A00A00/...
Framing profile F	black	9011	960 g/bar	1.41.71F0107.2.60
			160 g/m	1.41.71F0107.2-A00A00/...

/... = length in mm

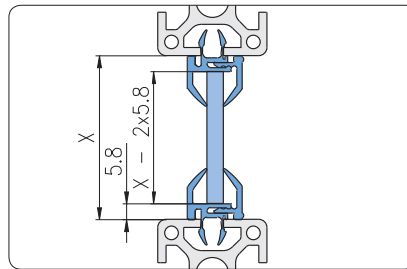
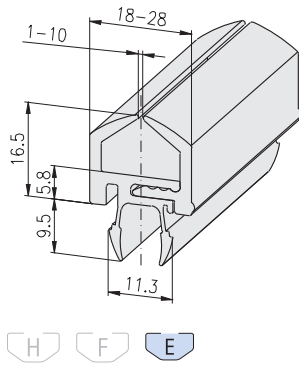

**Comments**

Suitable for panel elements from 1 to 10 mm thickness

Description	Colour	similar to RAL	Weight	Article-No.
Framing profile E	grey	7035	1,100 g/bar	1.41.71E0110.1.60
			181 g/m	1.41.71E0110.1-A00A00/...
Framing profile E	black	9011	1,100 g/bar	1.41.71E0110.2.60
			181 g/m	1.41.71E0110.2-A00A00/...

/... = length in mm

Rubber cover-profiles



Application

Rubber cover-profiles for profile protection  
Suitable for:

- door stop
- slide prevention on steps
- protection against damage
- handrails
- pads

Technical data

length of ring: 20 m  
material: NBR, hardness 80 Shore A  
oil and water resistant

Colour



black

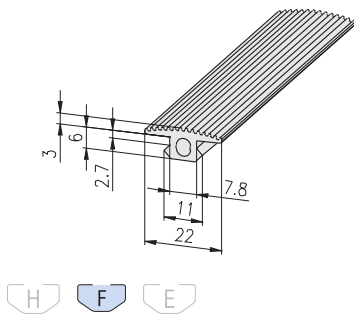

Description	Colour	Weight	Article-No.
Rubber cover-profile F	black	2,400 g/ring	1.41.8F30.20
		120 g/m	1.41.8F30-A00A00/...

/... = length in mm

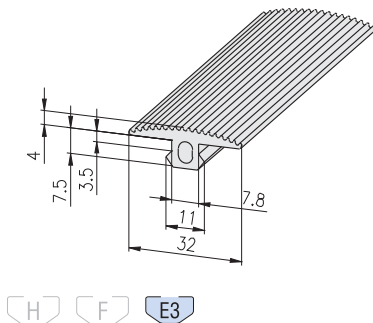

Description	Colour	Weight	Article-No.
Rubber cover-profile E3	black	4,400 g/ring	1.41.8E40.20
		220 g/m	1.41.8E40-A00A00/...

/... = length in mm

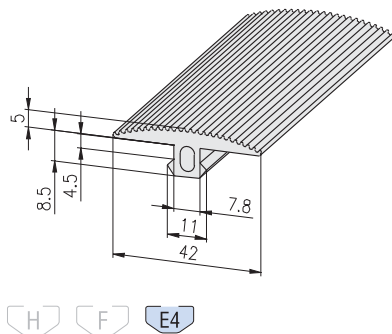

Description	Colour	Weight	Article-No.
Rubber cover-profile E4	black	6,400 g/ring	1.41.8E50.20
		320 g/m	1.41.8E50-A00A00/...

/... = length in mm

Cover caps



Application

Cover caps prevent dirt from entering and avoid lacerations.

Comments

Before mounting debur core hole

Technical data

material: PA-GF  
temperature range: -20°C to +85°C

Colours



for profiles without core hole

Rectangle

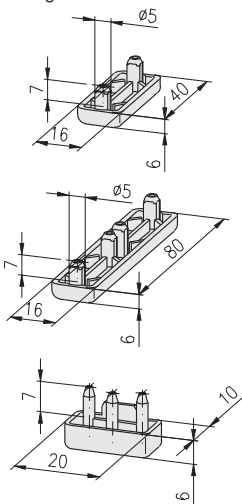

for tube profile

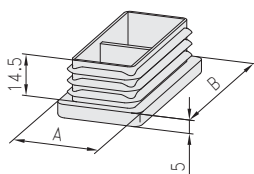

Description	Colour	Weight	Article-No.
Cover cap 16×40, E only for E-Slot	black	3.9 g	1.42.09016040.2

Description	Colour	Weight	Article-No.
Cover cap 16×80, E	grey	7.1 g	1.42.09016080.1
Cover cap 16×80, E only for E-Slot	black	7.1 g	1.42.09016080.2

Description	Colour	Weight	Article-No.
Cover cap 20×10	black	2 g	1.42.20201.2

Description	A×B	Colour	Weight	Article-No.
Cover cap	30×60 for tube profile	black	10.2 g	1.42.217.030060.2
Cover cap	30×100 for tube profile	black	17.7 g	1.42.217.030100.2

for profiles with core hole-Ø6

Soft

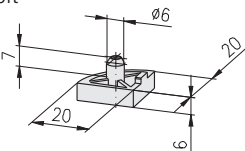

Square

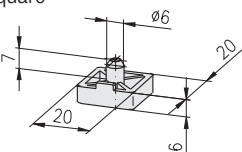

Rectangle

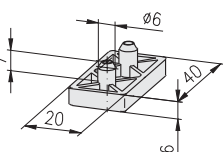

Description	Colour	Weight	Article-No.
Cover cap 20×20	grey	3 g	1.42.10200.1
Cover cap 20×20	black	3 g	1.42.10200.2

Description	Colour	Weight	Article-No.
Cover cap 20×20	grey	3 g	1.42.10202.1
Cover cap 20×20	black	3 g	1.42.10202.2

Description	Colour	Weight	Article-No.
Cover cap 20×40	grey	6 g	1.42.10204.1
Cover cap 20×40	black	6 g	1.42.10204.2

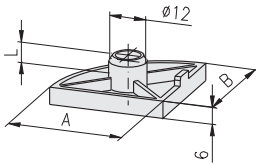
**for profiles with core hole-Ø12**
**Soft**

Description	A×B	L	Colour	Weight	Article-No.
Cover cap	30×30	7	grey	5 g	1.42.20300.1
Cover cap	30×30	7	black	5 g	1.42.20300.2
Cover cap	40×40	7	grey	8 g	1.42.20400.1
Cover cap	40×40	7	black	8 g	1.42.20400.2
Cover cap	45×45	14	black	10 g	1.42.2045000.2
Cover cap	50×50	7	grey	12 g	1.42.20500.1
Cover cap	50×50	7	black	12 g	1.42.20500.2

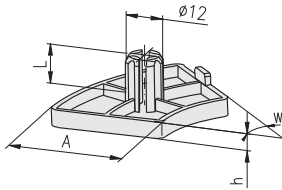
**Round**

**! note "h" !**

Description	A	W	h	L	Colour	Weight	Article-No.
Cover cap	40, round	30°	4	14	black	6 g	1.42.2040R30.2
Cover cap	40, round	45°	6	14	black	8 g	1.42.2040R45.2
Cover cap	40, round	60°	6	14	black	12 g	1.42.2040R60.2
Cover cap	40, round	90°	6	14	black	16 g	1.42.2040R90.2

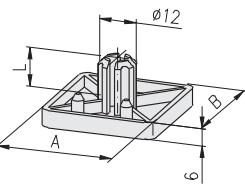
**Square**

Description	A×B	L	Colour	Weight	Article-No.
Cover cap	30×30	14	grey	6 g	1.42.20303.1
Cover cap	30×30	14	black	6 g	1.42.20303.2
Cover cap	40×40	14	grey	10 g	1.42.20404.1
Cover cap	40×40	14	black	10 g	1.42.20404.2
Cover cap	45×45	14	black	12 g	1.42.2045045.2
Cover cap	50×50	7	grey	15 g	1.42.20505.1
Cover cap	50×50	7	black	15 g	1.42.20505.2
Cover cap	60×60	14	black	18 g	1.42.2060060.2

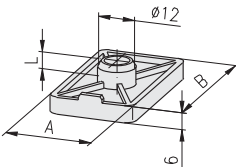
**Rectangle**

Description	A×B	L	Colour	Weight	Article-No.
Cover cap	20×30	7	grey	4 g	1.42.20203.1
Cover cap	20×30	7	black	4 g	1.42.20203.2
Cover cap	30×50	7	grey	8 g	1.42.20305.1
Cover cap	30×50	7	black	8 g	1.42.20305.2
Cover cap	45×60	14	black	12.1 g	1.42.2045060.2

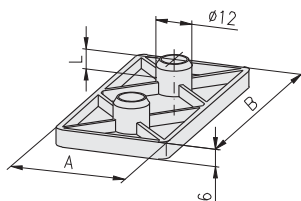
**Rectangle**

Description	A×B	L	Colour	Weight	Article-No.
Cover cap	30×60	7	grey	8 g	1.42.20306.1
Cover cap	30×60	7	black	8 g	1.42.20306.2
Cover cap	30×100	7	black	20 g	1.42.20310.2
<sup>1)</sup> Cover cap	30×150	7	black	27 g	1.42.20315.2
Cover cap	40×80	7	grey	18 g	1.42.20408.1
Cover cap	40×80	7	black	18 g	1.42.20408.2
Cover cap	45×90	14	black	20.5 g	1.42.2045090.2
Cover cap	50×100	7	grey	26 g	1.42.20510.1
Cover cap	50×100	7	black	26 g	1.42.20510.2
Cover cap	50×150	7	black	40 g	1.42.20515.2
Cover cap	60×90	14	black	25.9 g	1.42.2060090.2

<sup>1)</sup> only for E-Slot

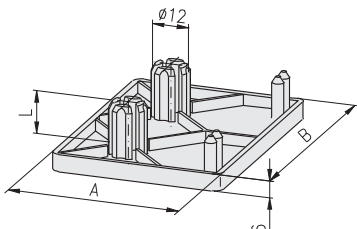

Description	A×B	L	Colour	Weight	Article-No.
Cover cap	60×80	14	black	21.4 g	1.42.2060080.2

for profiles with core hole-Ø12

Square

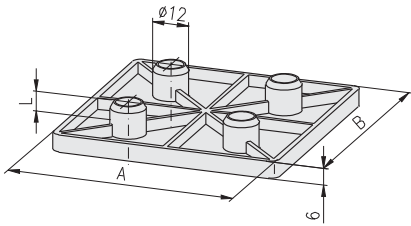

Description	A×B	L	Colour	Weight	Article-No.
Cover cap	80×80	7	black	34 g	1.42.20808.2
Cover cap	90×90	14	black	42 g	1.42.2090090.2
Cover cap	100×100	7	black	52 g	1.42.21010.2

Ø48 for hand rail profile

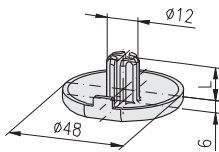

**Technical data**

material: PA-GF

Description	L	Colour	Weight	Article-No.
Cover cap Ø48 for hand rail profile	14	grey	1.8 g	1.42.2048R00.1
Cover cap Ø48 for hand rail profile	14	black	1.8 g	1.42.2048R00.2



Cover plugs



**Application**

The cover plug allows the closing of the connector cross bushing bore



Cover plug in combination with cover profile

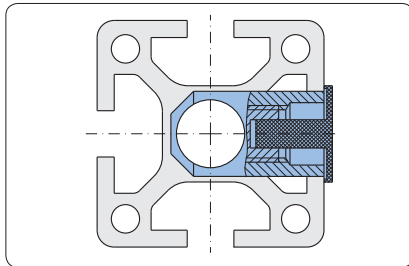

**Technical data**

material: PE

**Colours**



grey

black

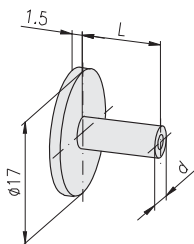

Description	Colour	L	d	Weight	Article-No.
Cover plug 20	grey	3.5	Ø4.3	2 g	1.42.502.1
Cover plug 20	black	3.5	Ø4.3	2 g	1.42.502.2
Cover plug 30	grey	6.0	Ø5.3	3 g	1.42.503.1
Cover plug 30	black	6.0	Ø5.3	3 g	1.42.503.2
Cover plug 40	grey	11.0	Ø5.3	4 g	1.42.504.1
Cover plug 40	black	11.0	Ø5.3	4 g	1.42.504.2
Cover plug 50	grey	16.0	Ø5.3	5 g	1.42.505.1
Cover plug 50	black	16.0	Ø5.3	5 g	1.42.505.2

Cover plugs domed

C

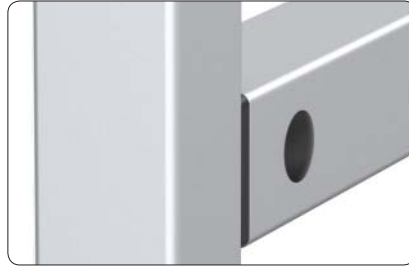

Application

The cover plug allows the closing of the connector cross bushing bore

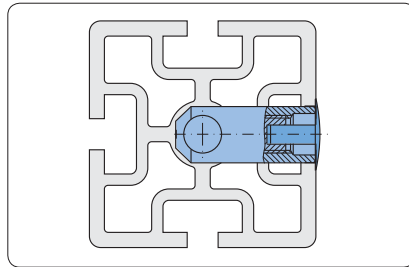

Technical data

material: PE

Colours

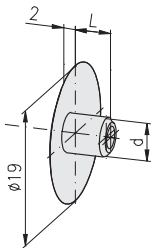

Description	Colour	L	d	Weight	Article-No.
Cover plug 20 domed	grey	3.5	Ø4.3	0.2 g	1.42.5120.1
Cover plug 20 domed	black	3.5	Ø4.3	0.2 g	1.42.5120.2
Cover plug 30 domed	grey	6.0	Ø5.3	0.3 g	1.42.5130.1
Cover plug 30 domed	black	6.0	Ø5.3	0.3 g	1.42.5130.2
Cover plug 40 domed	grey	11.0	Ø5.3	0.4 g	1.42.5140.1
Cover plug 40 domed	black	11.0	Ø5.3	0.4 g	1.42.5140.2
Cover plug 45 domed	grey	12.5	Ø5.3	0.4 g	1.42.5145.1
Cover plug 45 domed	black	12.5	Ø5.3	0.4 g	1.42.5145.2
Cover plug 50 domed	grey	15.0	Ø5.3	0.5 g	1.42.5150.1
Cover plug 50 domed	black	15.0	Ø5.3	0.5 g	1.42.5150.2
Cover plug 60 domed	grey	20.0	Ø5.3	0.7 g	1.42.5160.1
Cover plug 60 domed	black	20.0	Ø5.3	0.7 g	1.42.5160.2

**Cover caps for tubes**



**Application**

The cover cap allows the closing of the aluminium tube (inner tube  $\varnothing = d$ )

**Technical data**

material: PE

**Colours**

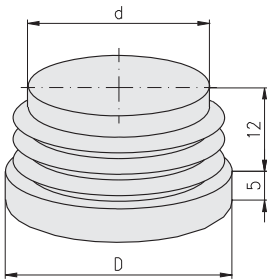

Description	D	Colour	d	Weight	Article-No.
Tube cover cap	Ø20	grey	Ø16	1.8 g	1.42.6020.1
Tube cover cap	Ø20	black	Ø16	1.8 g	1.42.6020.2
Tube cover cap	Ø30	grey	Ø24	3.4 g	1.42.6030.1
Tube cover cap	Ø30	black	Ø24	3.4 g	1.42.6030.2
Tube cover cap	Ø40	grey	Ø32	5.3 g	1.42.6040.1
Tube cover cap	Ø40	black	Ø32	5.3 g	1.42.6040.2

**Cover caps for screw bores**

C

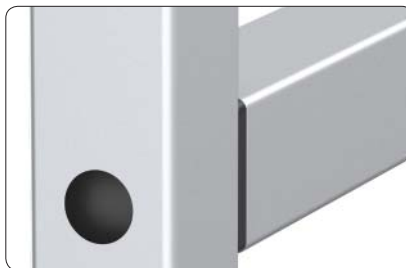

**Application**

The cover plug allows the closing of the screw bore

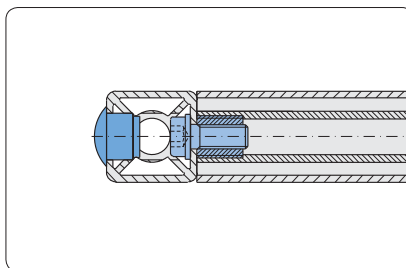

Profile 30

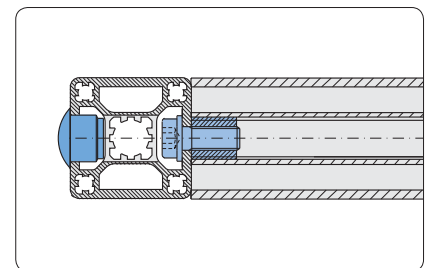

Profile 40

**Technical data**

material: PE

**Colours**

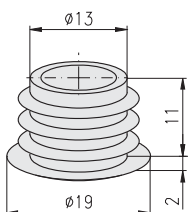

Description	Colour	Weight	Article-No.
Cover plug	Ø15 grey	1.3 g	1.42.6114.1
Cover plug	Ø15 black	1.3 g	1.42.6114.2

Radius covers

C

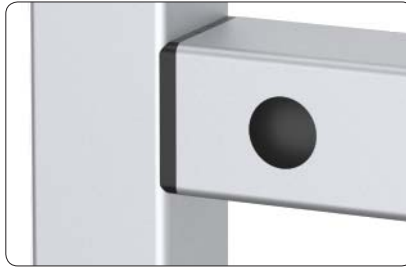

Application

For covering the exterior profile radius

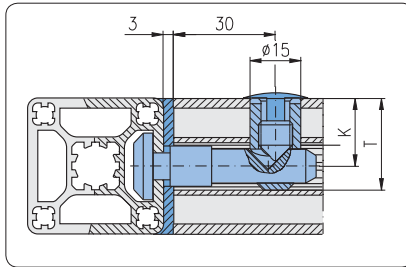

Drill dimensions by use of radius covers  
(dimensions K, T → connector-cross bushings 1.2B)

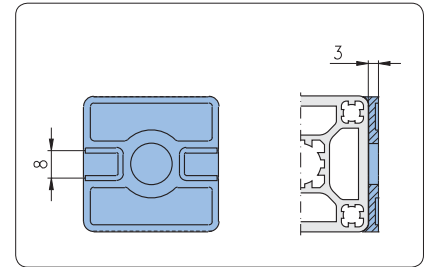

For mounting of panels the slots can be broken out

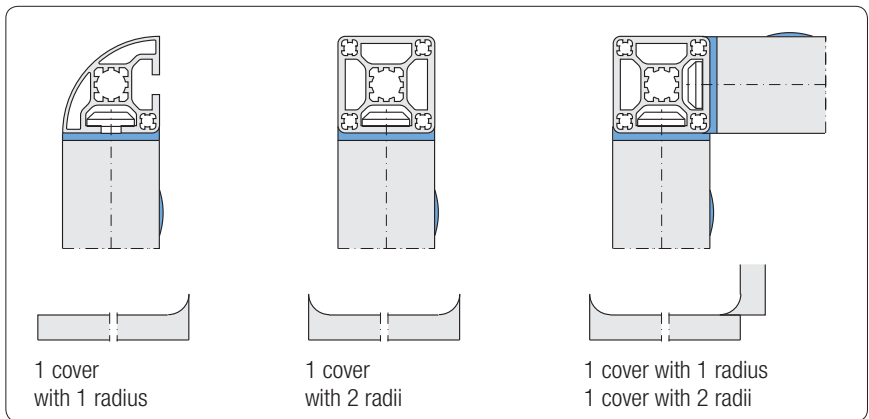

Mounting-Variations

Technical data

material: PA-GF

Colours



Square  
with one radius

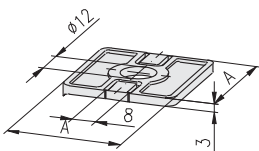

Description	A	Colour	Weight	Article-No.
Radius cover 1R	30	grey	3.1 g	1.43.10030030.1
Radius cover 1R	30	black	3.1 g	1.43.10030030.2
Radius cover 1R	40	grey	6.1 g	1.43.10040040.1
Radius cover 1R	40	black	6.1 g	1.43.10040040.2
Radius cover 1R	45	grey	5.4 g	1.43.10045045.1
Radius cover 1R	45	black	5.4 g	1.43.10045045.2

Rectangle  
with one radius

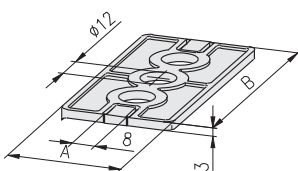

Description	A	B	Colour	Weight	Article-No.
Radius cover 1R	30	60	grey	5.8 g	1.43.10030060.1
Radius cover 1R	30	60	black	5.8 g	1.43.10030060.2
Radius cover 1R	40	80	grey	11.8 g	1.43.10040080.1
Radius cover 1R	40	80	black	11.8 g	1.43.10040080.2
Radius cover 1R	45	90	grey	10.7 g	1.43.10045090.1
Radius cover 1R	45	90	black	10.7 g	1.43.10045090.2

**Rectangle 90°**  
with one radius

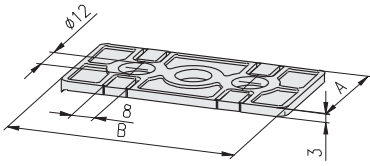

Description	A	B	Colour	Weight	Article-No.
Radius cover 1R	30	60	grey	5.8 g	1.43.11030060.1
Radius cover 1R	30	60	black	5.8 g	1.43.11030060.2
Radius cover 1R	40	80	grey	11.8 g	1.43.11040080.1
Radius cover 1R	40	80	black	11.8 g	1.43.11040080.2
Radius cover 1R	45	90	grey	10.8 g	1.43.11045090.1
Radius cover 1R	45	90	black	10.8 g	1.43.11045090.2

**Square**  
with one radius

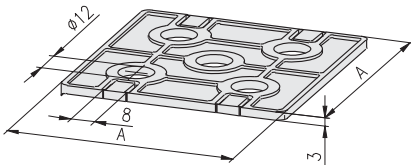

Description	A	Colour	Weight	Article-No.
Radius cover 1R	60	grey	12.0 g	1.43.10060060.1
Radius cover 1R	60	black	12.0 g	1.43.10060060.2
Radius cover 1R	80	grey	24.0 g	1.43.10080080.1
Radius cover 1R	80	black	24.0 g	1.43.10080080.2

**Square**  
with two radii

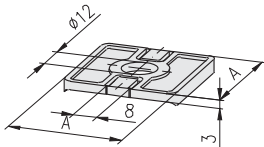

Description	A	Colour	Weight	Article-No.
Radius cover 2R	30	grey	3.2 g	1.43.20030030.1
Radius cover 2R	30	black	3.2 g	1.43.20030030.2
Radius cover 2R	40	grey	6.3 g	1.43.20040040.1
Radius cover 2R	40	black	6.3 g	1.43.20040040.2
Radius cover 2R	45	grey	5.6 g	1.43.20045045.1
Radius cover 2R	45	black	5.6 g	1.43.20045045.2

**Rectangle**  
with two radii

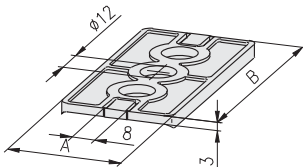

Description	A	B	Colour	Weight	Article-No.
Radius cover 2R	30	60	grey	6.0 g	1.43.20030060.1
Radius cover 2R	30	60	black	6.0 g	1.43.20030060.2
Radius cover 2R	40	80	grey	12.0 g	1.43.20040080.1
Radius cover 2R	40	80	black	12.0 g	1.43.20040080.2
Radius cover 2R	45	90	grey	10.9 g	1.43.20045090.1
Radius cover 2R	45	90	black	10.9 g	1.43.20045090.2

**Rectangle 90°**  
with two radii

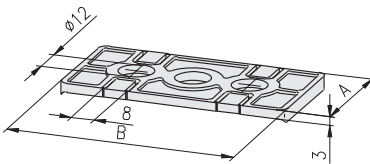

Description	A	B	Colour	Weight	Article-No.
Radius cover 2R	30	60	grey	6.0 g	1.43.21030060.1
Radius cover 2R	30	60	black	6.0 g	1.43.21030060.2
Radius cover 2R	40	80	grey	12.0 g	1.43.21040080.1
Radius cover 2R	40	80	black	12.0 g	1.43.21040080.2
Radius cover 2R	45	90	grey	11.0 g	1.43.21045090.1
Radius cover 2R	45	90	black	11.0 g	1.43.21045090.2

**Square**  
with two radii

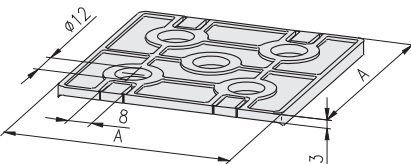

Description	A	Colour	Weight	Article-No.
Radius cover 2R	60	grey	12.0 g	1.43.20060060.1
Radius cover 2R	60	black	12.0 g	1.43.20060060.2
Radius cover 2R	80	grey	24.0 g	1.43.20080080.1
Radius cover 2R	80	black	24.0 g	1.43.20080080.2

Radius compensations

C



Post: Profile 40x40

Application

Radius compensation for hand rails  
 ↳ Profile applications 1.1E.03

Comments

Angled joints at any required angle  
 Not suitably for the use with tilted hand rails

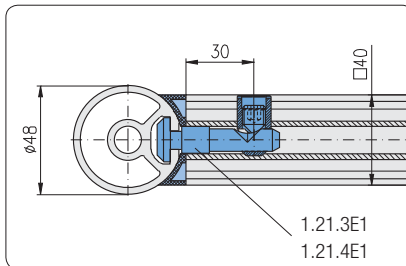

Working dimensions for hand rail straight with radius compensation

Technical data

material: PA-GF

Colours

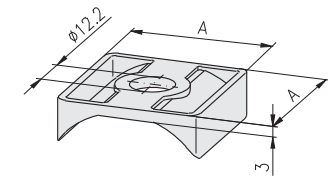

- 16
- 20
- 30
- 40
- 45
- 50
- 60

Description	AxA	Colour	Weight	Article-No.
Radius compensations	30x30	grey	4.0 g	1.43.71030030.1
Radius compensations	30x30	black	4.0 g	1.43.71030030.2
Radius compensations	40x40	grey	7.0 g	1.43.71040040.1
Radius compensations	40x40	black	7.0 g	1.43.71040040.2



Post: Profile Ø48

Technical data

material: PA-GF

Colours

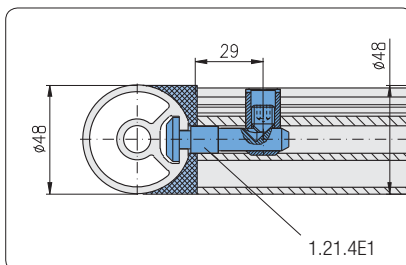

Working dimensions for hand rail straight with radius compensation

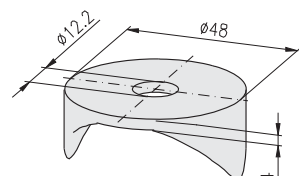

Description	Colour	Weight	Article-No.
Radius compensations Ø48	grey	4.0 g	1.43.71048000.1
Radius compensations Ø48	black	4.0 g	1.43.71048000.2

Levelling feet



Assembly

Fastening in core hole Ø6 mm with thread M8

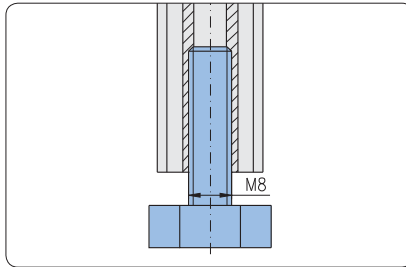

Fastening in core hole Ø6 mm with thread M8

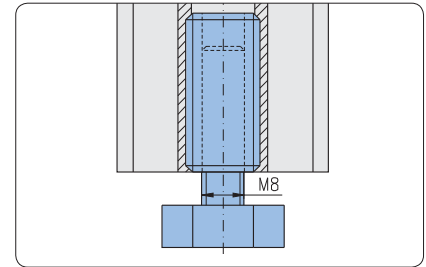

Fastening in core hole Ø12 with threaded insert M14/M8

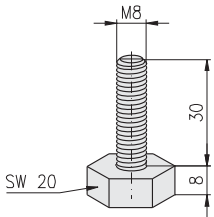

Technical data

- material:
- plate: PE-HD
  - screw: steel, galvanised
- max. static load: 2,500 N

Description

Floor levelling screw, SW20, M8x30

Weight

20 g

Article-No.

1.44.002003

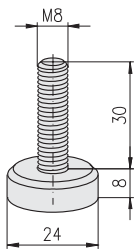

Technical data

- material:
- plate: PE-HD
  - screw: steel, galvanised
- max. static load: 2,500 N

Description

Floor levelling screw, Ø24, M8x30

Weight

22 g

Article-No.

1.44.002403

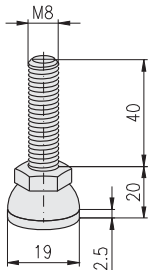

Technical data

- material:
- foot plate: PA, black
  - threaded bolt: steel, galvanised
- max. static load: 500 N  
with anti-slip-disc

Description

Levelling foot, PA, 20 M8x40

Weight

24 g

Article-No.

1.44.003020

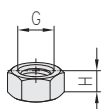

Technical data

- material: steel, galvanised

Description

Nut

G M8

H 5

Weight

5 g

Article-No.

1.44.46M08

Hand adjustable feet



**Application**

For manual levelling of benches, tables and light bases.

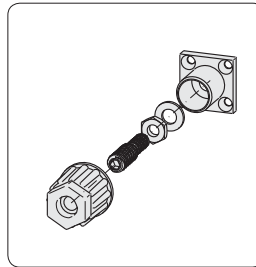

Height adjustable alternative by hand or with tool

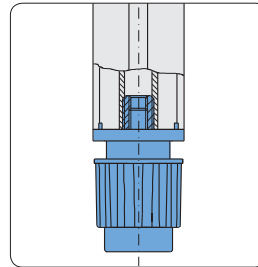

Fastening in core hole

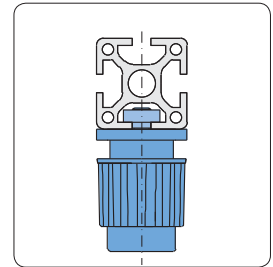

Fastening in slot

**Technical data**

material:

- capsule: PA, black
  - spindle, nut and washer: steel galvanised
- max. static load: 1,500 N

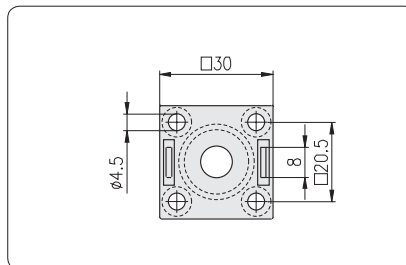
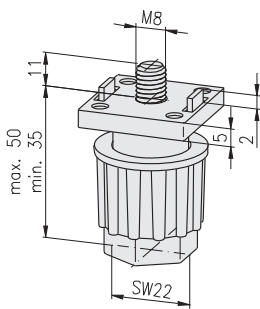

**Description**

Hand adjustable foot 30

**Weight**

40 g

**Article-No.**

1.44.203008

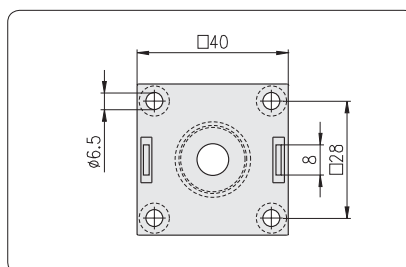
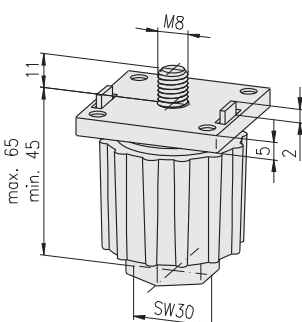

**Description**

Hand adjustable foot 40

**Weight**

78 g

**Article-No.**

1.44.204008



Levelling feet



**Assembly**

Fastening in core hole with threaded insert  
M14/M10

For profiles with core hole-Ø 12 mm

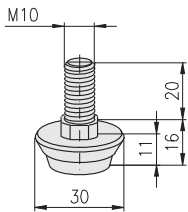

**Technical data**

material:

- foot plate: PA, black
- cap: steel, galvanised
- screw thread: steel, galvanised
- max. static load: 1,500 N

**Description**

Levelling furniture foot, Ø30, M10x18

**Weight**

**Article-No.**

24 g

1.44.303002

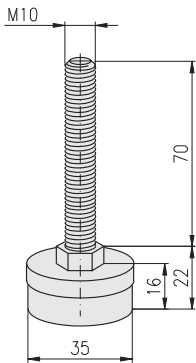

**Technical data**

material:

- foot plate: PA, black
- cap: steel, galvanised
- screw thread: steel, galvanised
- max. static load: 1,500 N

**Description**

Levelling foot, Ø35, M10x70

**Weight**

**Article-No.**

70 g

1.44.303507

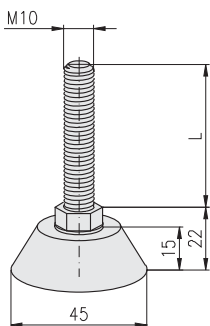

**Technical data**

material:

- foot plate: PA, black
- screw thread: steel, galvanised
- max. static load: 1,500 N

**Description**

**L**

**Weight**

**Article-No.**

Levelling foot, Ø45, M10x50

60 g

1.44.304505

Levelling foot, Ø45, M10x70

69 g

1.44.304507

Adjustable tilt-feet



**Application**

Adjustable tilt-feet for gradual height adjustment of sub-assemblies such as:

- tables
- bases
- shelves
- stands



Fastening in core hole thread M14



Fastening with base plate, for profiles without centric core hole



Fastening by press-fit threaded insert across the profile

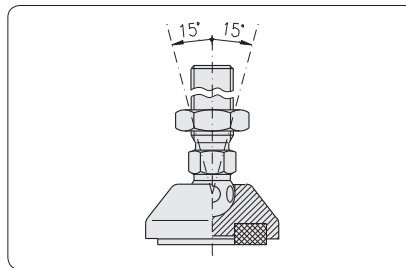

Levelling via ball and ball socket  $\pm 15^\circ$

**Comments**

Infinitely variable adjustable tilt-feet for use either with:

- anti-slip disc
- cushion element

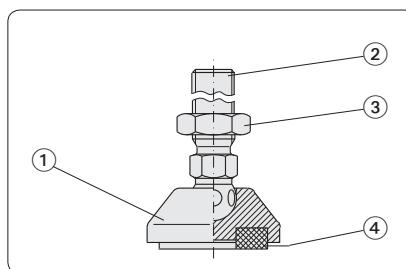

Adjustable tilt-feet - Single parts						
Pos.	Description	Material				
		PA	GD-Zn	Steel	Stainl. steel	NBR 1.4305
①	plate	•	•		•	
②	spindle			•	•	
③	nut			•	•	
④	anti-slip disc cushion element					• •

**Adjustable tilt-foot plates without mounting holes**

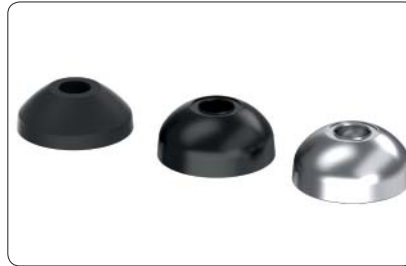

**Technical data**

material:

PA: PA-GF, black

GD-Zn: GD-Zn, black powder-coated

stainless: stainless steel 1.4305

F = static load max. in kN

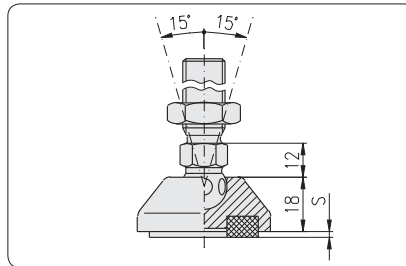
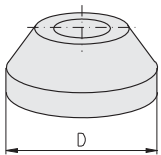

Design without mounting holes

S = height of:

- anti-slip disc (S = 2 mm)

- cushion element (S = 10 mm)

	Description	D	F	Weight	Article-No.
PA	Adjustable tilt-foot plate PA, 30	Ø29	5 kN	8 g	1.44.411030
	Adjustable tilt-foot plate PA, 40	Ø39	9 kN	13 g	1.44.411040
	Adjustable tilt-foot plate PA, 45	Ø44	9 kN	15 g	1.44.411045
	Adjustable tilt-foot plate PA, 50	Ø49	9 kN	16 g	1.44.411050
	Adjustable tilt-foot plate PA, 60	Ø59	9 kN	22 g	1.44.411060
GD-Zn	Adjustable tilt-foot plate GD-Zn, 30	Ø29	20 kN	48 g	1.44.431030
	Adjustable tilt-foot plate GD-Zn, 40	Ø39	30 kN	70 g	1.44.431040
	Adjustable tilt-foot plate GD-Zn, 45	Ø44	30 kN	90 g	1.44.431045
	Adjustable tilt-foot plate GD-Zn, 50	Ø49	30 kN	126 g	1.44.431050
	Adjustable tilt-foot plate GD-Zn, 60	Ø59	30 kN	160 g	1.44.431060
	Adjustable tilt-foot plate GD-Zn, 80	Ø79	30 kN	260 g	1.44.431080
	Adjustable tilt-foot plate GD-Zn, 100	Ø99	35 kN	400 g	1.44.431100
	Adjustable tilt-foot plate GD-Zn, 120	Ø119	35 kN	584 g	1.44.431120
Stainless steel	<span>C</span> <span>R</span> Adjustable tilt-foot plate, 30	Ø29	20 kN	62 g	1.44.431030V
	Adjustable tilt-foot plate, 40	Ø39	30 kN	99 g	1.44.431040V
	Adjustable tilt-foot plate, 45	Ø44	30 kN	123 g	1.44.431045V
	Adjustable tilt-foot plate, 50	Ø49	35 kN	158 g	1.44.431050V
	Adjustable tilt-foot plate, 60	Ø59	35 kN	218 g	1.44.431060V
	Adjustable tilt-foot plate, 80	Ø79	35 kN	380 g	1.44.431080V
	Adjustable tilt-foot plate, 100	Ø99	40 kN	605 g	1.44.431100V
	Adjustable tilt-foot plate, 120	Ø119	40 kN	844 g	1.44.431120V

Adjustable tilt-foot plates with mounting holes

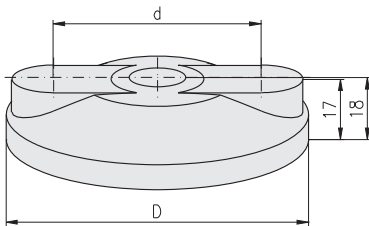

Technical data

material:  
PA: PA-GF, black  
F = static load max. in kN

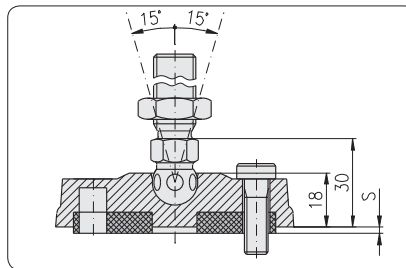

Comments

The holes for fastening screws are closed on the upper side and can be bored open if required.

S = height of:  
• anti-slip disc (S = 2 mm)  
• cushion element (S = 10 mm)

Design with mounting holes

PA

Description	D	d	F	Weight	Article-No.
Adjustable tilt-foot plate PA, 80	Ø79	Ø54	9 kN	46 g	1.44.411080
Adjustable tilt-foot plate PA, 100	Ø99	Ø74	9 kN	86 g	1.44.411100
Adjustable tilt-foot plate PA, 120	Ø119	Ø94	9 kN	104 g	1.44.411120



Technical data

material:  
GD-Zn: GD-Zn, black powder-coated  
stainless: stainless steel 1.4305 pickled and passivated  
F = static load max. in kN

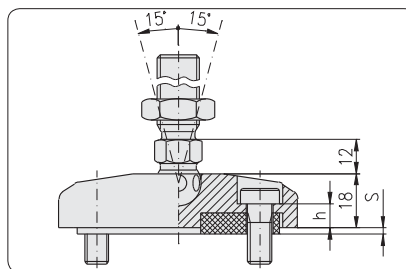
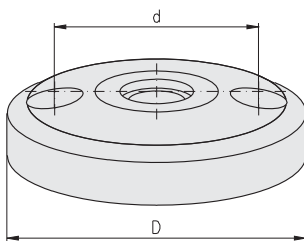

Comments

Fixing drilling with counterbore DIN 74 - M8 for cap-screw DIN 6912-M8

S = height of:  
• anti-slip disc (S = 2 mm)  
• cushion element (S = 10 mm)

Design with mounting holes

GD-Zn

Description	D	h	d	F	Weight	Article-No.
Adjustable tilt-foot plate steel, 80	Ø79	11.5	Ø54	30 kN	260 g	1.44.432080
Adjustable tilt-foot plate steel, 100	Ø99	11.5	Ø74	35 kN	377 g	1.44.432100
Adjustable tilt-foot plate steel, 120	Ø119	11.5	Ø94	35 kN	570 g	1.44.432120

Stainless steel



Adjustable tilt-foot plate stain., 80	Ø79	11.0	Ø54	30 kN	354 g	1.44.432080V
Adjustable tilt-foot plate stain., 100	Ø99	11.0	Ø74	40 kN	587 g	1.44.432100V
Adjustable tilt-foot plate stain., 120	Ø119	11.0	Ø94	40 kN	830 g	1.44.432120V

Adjustable tilt-foot spindles



Technical data

material:  
 steel: steel, galvanised  
 stainless: stainless steel 1.4305,  
 pickled and passivated

Steel

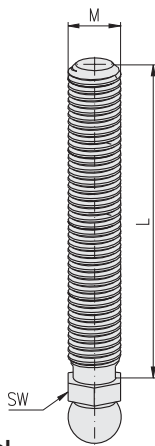

Stainless steel

C R

Description	G × L	SW	Weight	Article-No.
Adjustable tilt-foot spindle, steel	M8 × 40	14	17 g	1.44.4608040
Adjustable tilt-foot spindle, steel	M8 × 80	14	31 g	1.44.4608080
Adjustable tilt-foot spindle, steel	M10 × 45	14	37 g	1.44.4610045
Adjustable tilt-foot spindle, steel	M10 × 90	14	51 g	1.44.4610090
Adjustable tilt-foot spindle, steel	M12 × 66	14	56 g	1.44.4612066
Adjustable tilt-foot spindle, steel	M12 × 100	14	79 g	1.44.4612100
Adjustable tilt-foot spindle, steel	M14 × 66	14	87 g	1.44.4614066
Adjustable tilt-foot spindle, steel	M14 × 100	14	119 g	1.44.4614100
Adjustable tilt-foot spindle, steel	M14 × 150	14	166 g	1.44.4614150
Adjustable tilt-foot spindle, steel	M16 × 66	17	111 g	1.44.4616066
Adjustable tilt-foot spindle, steel	M16 × 100	17	155 g	1.44.4616100
Adjustable tilt-foot spindle, steel	M16 × 150	17	220 g	1.44.4616150
Adjustable tilt-foot spindle, steel	M20 × 100	22	237 g	1.44.4620100
Adjustable tilt-foot spindle, steel	M20 × 150	22	331 g	1.44.4620150
Adjustable tilt-foot spindle, stainless	M14 × 66	14	87 g	1.44.4614066V
Adjustable tilt-foot spindle, stainless	M14 × 88	14	104 g	1.44.4614088V
Adjustable tilt-foot spindle, stainless	M14 × 100	14	119 g	1.44.4614100V
Adjustable tilt-foot spindle, stainless	M14 × 125	14	138 g	1.44.4614125V
Adjustable tilt-foot spindle, stainless	M14 × 150	14	166 g	1.44.4614150V

Adjustable tilt-foot nuts



Technical data

material:  
 steel: steel, galvanised  
 stainless: stainless steel 1.4305,  
 pickled and passivated

Steel

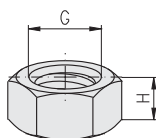

Stainless steel

C R

Description	G	H	Weight	Article-No.
Nut	M8	5	5 g	1.44.46M08
Nut	M10	6	8 g	1.44.46M10
Nut	M12	7	10 g	1.44.46M12
Nut	M14	8	16 g	1.44.46M14
Nut	M16	8	17 g	1.44.46M16
Nut	M20	9	35 g	1.44.46M20
Nut, stainless	M14	8	16 g	1.44.46M14V

Adjustable tilt-foot anti-slip discs

C



Application

Element for protection against dislocation and floor damage

Technical data

material: NBR, oil and water resistant  
 colour: black  
 hardness: 80 Shore A  
 F = static load max. in KN

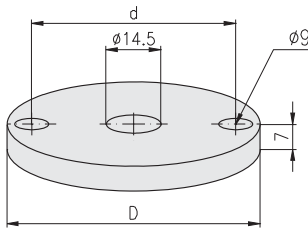
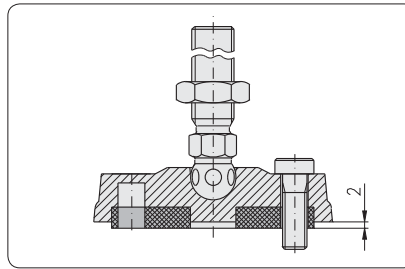

Description

Description	D	d	F	Weight	Article-No.
Adj. tilt-foot anti-slip disc for plate 30	Ø20	-	5 kN	2.0 g	1.44.471030
Adj. tilt-foot anti-slip disc for plate 40	Ø30	-	6 kN	4.0 g	1.44.471040
Adj. tilt-foot anti-slip disc for plate 45	Ø35	-	7 kN	5.5 g	1.44.471045
Adj. tilt-foot anti-slip disc for plate 50	Ø39	-	8 kN	7.5 g	1.44.471050
Adj. tilt-foot anti-slip disc for plate 60	Ø49	-	9 kN	12.0 g	1.44.471060
Adj. tilt-foot anti-slip disc for plate 80	Ø67	Ø54	10 kN	22.0 g	1.44.471080
Adj. tilt-foot anti-slip disc for plate 100	Ø87	Ø74	10 kN	36.0 g	1.44.471100
Adj. tilt-foot anti-slip disc for plate 120	Ø107	Ø94	10 kN	57.0 g	1.44.471120

Adjustable tilt-foot cushion elements

C



Application

Cushion elements

Technical data

material: NBR, oil and water resistant  
 colour: black  
 hardness: 70 Shore A  
 F = static load max. in N

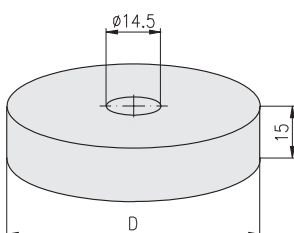
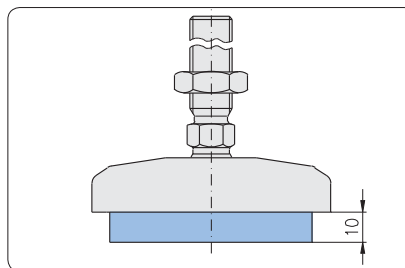

Description

Description	D	F	Weight	Article-No.
Adj. tilt-foot cushion element for plate 40	Ø30	150 N	14 g	1.44.472040
Adj. tilt-foot cushion element for plate 45	Ø35	175 N	19 g	1.44.472045
Adj. tilt-foot cushion element for plate 50	Ø39	200 N	24 g	1.44.472050
Adj. tilt-foot cushion element for plate 60	Ø49	250 N	35 g	1.44.472060
Adj. tilt-foot cushion element for plate 80	Ø67	500 N	68 g	1.44.472080
Adj. tilt-foot cushion element for plate 100	Ø87	800 N	118 g	1.44.472100
Adj. tilt-foot cushion element for plate 120	Ø107	1,200 N	188 g	1.44.472120

**Angular adjusting feet**



**Application**

For fastening of frames to floor or wall

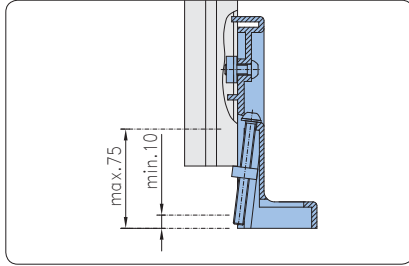

**Technical data**

material:

- base body: GD-Al, black
- nuts: steel galvanised
- screws: steel galvanised
- max. static load: 10,000 N

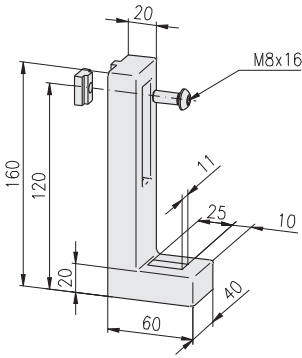

**Delivery unit**

- base body
- nut M8
- screw M8×16 - 10.9

**Description**

Angular adjusting foot without adjusting screw

**Weight**

**Article-No.**

468 g

1.44.716001

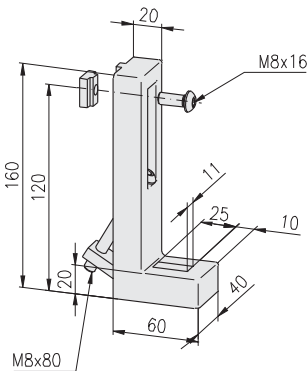

**Delivery unit:**

- base body
- nut M8
- screw M8×16 - 10.9
- screw M8×80 - 10.9
- square nut

**Description**

Angular adjusting foot with adjusting screw

**Weight**

**Article-No.**

519 g

1.44.716002

**Base foot  
for profile 40×40**



**Application**

Base feet for fastening profiles and frames to floor or wall

**Technical data**

material: GD-Zn

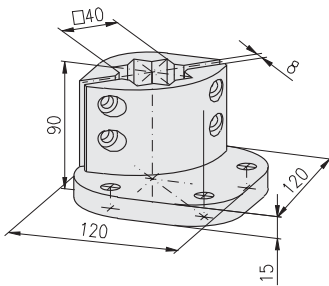
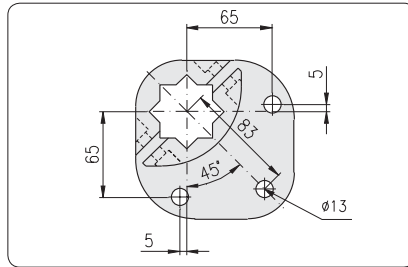

**Description**

Base foot for profile 40×40

**Weight**

979 g

**Article-No.**

1.44.83040

**Floor mounting set**

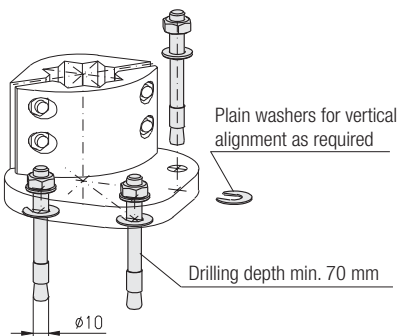

**Description**

Floor mounting set 3 MKT

**Weight**

202.3 g

**Article-No.**

1.44.83BB

**Single parts**

Pin anchor MKT, B10/20/95

**Pcs.**

3

**Weight**

65.3 g

**Article-No.**

0.66.MKT.B1020/95

Plain washer 1×Ø24/11

8

0.8 g

1.44.89011324



Base feet



**Application**

Base feet for fastening profiles and frames to floor or wall

**Technical data**

material: GK AlZn 10Si8Mg

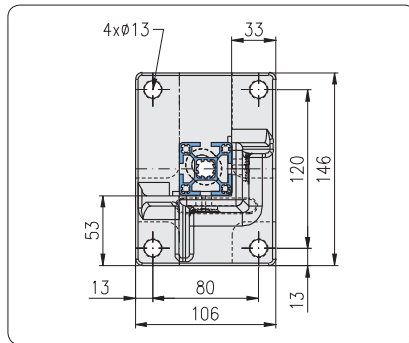
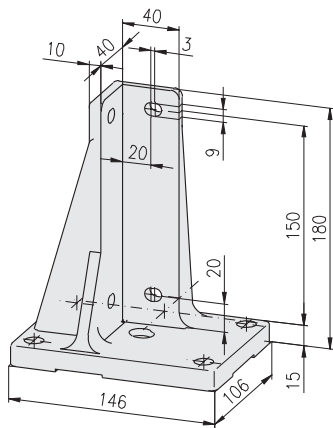

40x40, type 1, left

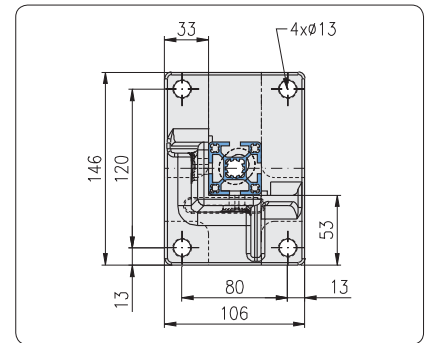

40x40, type 1, right

**Comments**

3D picture shows type 1, right  
mirror-inverted: type 1, left

**Mounting sets** (↔ 195, 196)

Floor mounting set 4 MKT  
Profile mounting set 4 EM8

**Description**

Description	for profile	Weight	Article-No.
Base foot 40x40, type 1, left	40x40, 45x45	1.06 kg	1.44.84.4040.00L
Base foot 40x40, type 1, right	40x40, 45x45	1.06 kg	1.44.84.4040.00R

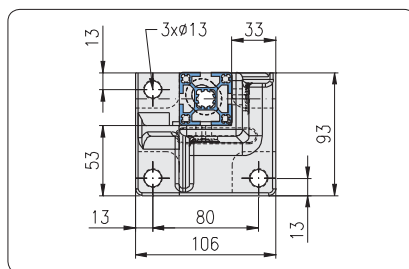
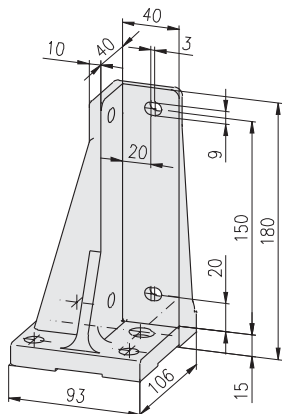

40x40, type 2, left

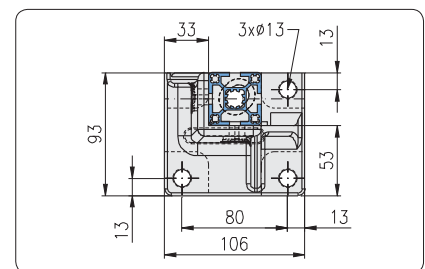

40x40, type 2, right

**Comments**

3D picture shows type 2, right  
mirror-inverted: type 2, left

**Mounting sets** (↔ 195, 196)

Floor mounting set 3 MKT  
Profile mounting set 4 EM8

**Description**

Description	for profile	Weight	Article-No.
Base foot 40x40, type 2, left	40x40	0.83 kg	1.44.84.4040.40L
Base foot 40x40, type 2, right	40x40	0.83 kg	1.44.84.4040.40R

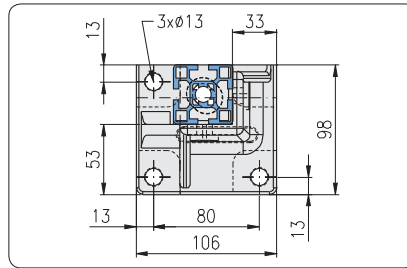
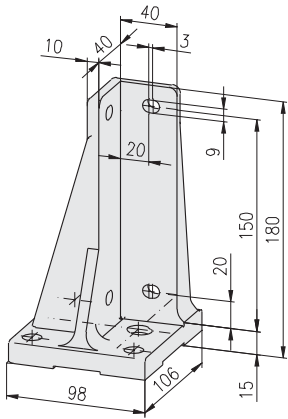

45x45, type 2, left

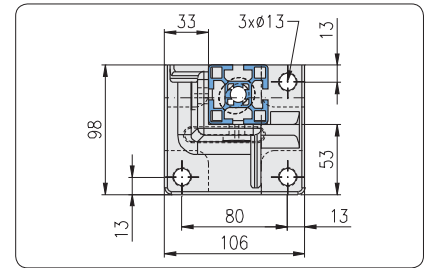

45x45, type 2, right

**Comments**

3D picture shows type 2, right  
mirror-inverted: type 2, left

**Mounting sets** (→ 195, 196)

Floor mounting set 3 MKT  
Profile mounting set 4 EM8

Description	for profile	Weight	Article-No.
Base foot 45x45, type 2, left	45x45	0.85 kg	1.44.84.4545.45L
Base foot 45x45, type 2, right	45x45	0.85 kg	1.44.84.4545.45R

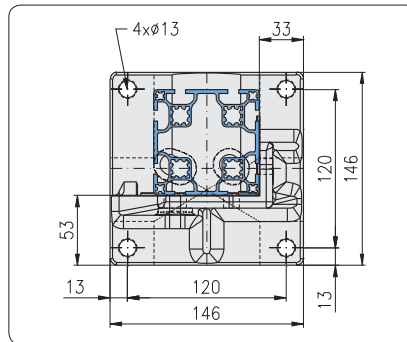
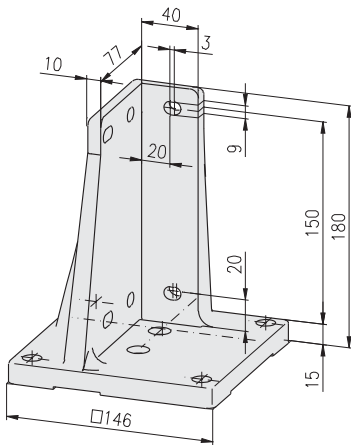

40x80, type 1, left

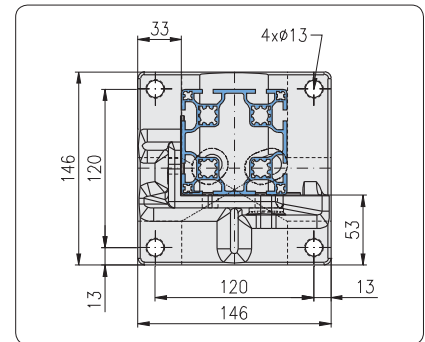

40x80, type 1, right

**Comments**

3D picture shows type 1, right  
mirror-inverted: type 1, left

**Mounting sets** (→ 195, 196)

Floor mounting set 4 MKT  
Profile mounting set 6 EM8

Description	for profile	Weight	Article-No.
Base foot 40x80, type 1, left	40x80, 60x80, 45x90	1.39 kg	1.44.84.4080.00L
Base foot 40x80, type 1, right	40x80, 60x80, 45x90	1.39 kg	1.44.84.4080.00R

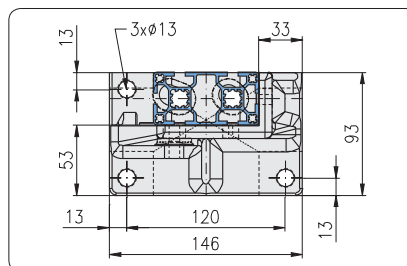
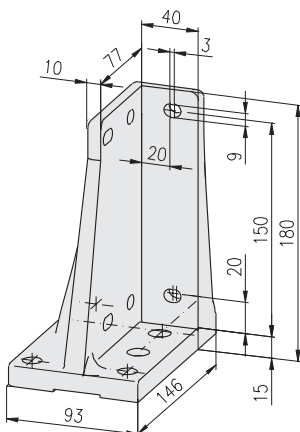

40x80, type 2, left

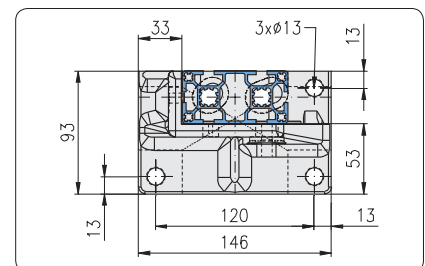

40x80, type 2, right

**Comments**

3D picture shows type 2, right  
mirror-inverted: type 2, left

**Mounting sets** (→ 195, 196)

Floor mounting set 3 MKT  
Profile mounting set 6 EM8

Description	for profile	Weight	Article-No.
Base foot 40x80, type 2, left	40x80	1.01 kg	1.44.84.4080.40L
Base foot 40x80, type 2, right	40x80	1.01 kg	1.44.84.4080.40R

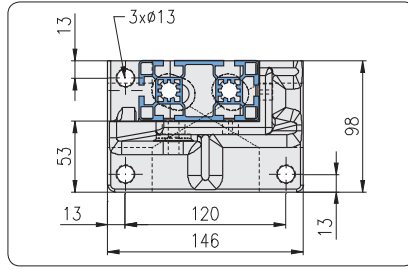
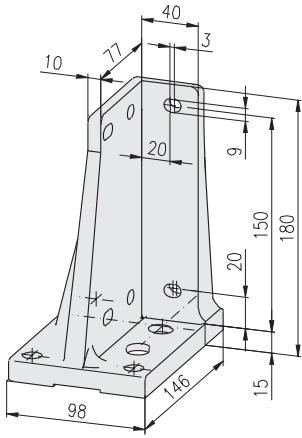

45x90, type 2, left

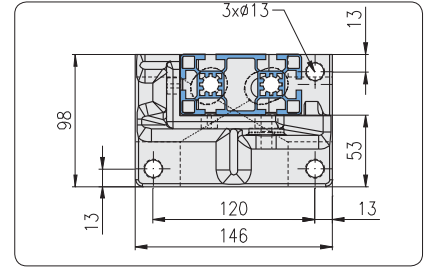

45x90, type 2, right

**Comments**

3D picture shows type 2, right  
mirror-inverted: type 2, left

**Mounting sets** (↔ 195, 196)

Floor mounting set 3 MKT  
Profile mounting set 6 EM8

Description	for profile	Weight	Article-No.
Base foot 45x90, type 2, left	45x90	1.10 kg	1.44.84.4590.45L
Base foot 45x90, type 2, right	45x90	1.10 kg	1.44.84.4590.45R

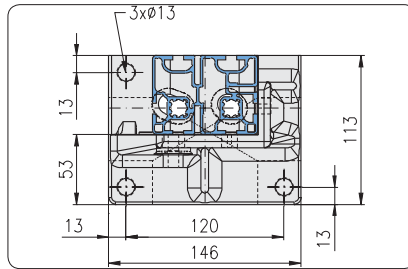
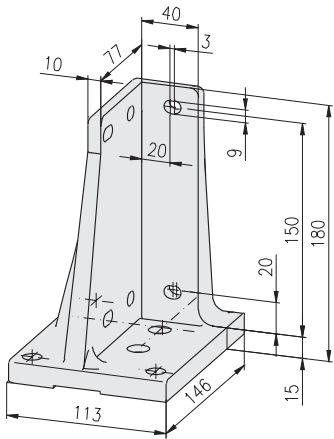

60x80, type 2, left

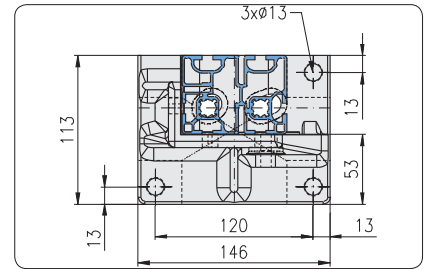

60x80, type 2, right

**Comments**

3D picture shows type 2, right  
mirror-inverted: type 2, left

**Mounting sets** (↔ 195, 196)

Floor mounting set 3 MKT  
Profile mounting set 6 EM8

Description	for profile	Weight	Article-No.
Base foot 60x80, type 2, left	60x80	1.25 kg	1.44.84.6080.60L
Base foot 60x80, type 2, right	60x80	1.25 kg	1.44.84.6080.60R

**Floor mounting sets**

Cross-reference list for base feet and floor mounting sets			
Base foot	Article-No.	Floor mounting set	
		3 MKT, 1.44.83BB	4 MKT, 1.44.84BB
40×40, type 1, le/ri	1.44.84.4040.00x		•
40×40, type 2, le/ri	1.44.84.4040.40x	•	
40×80, type 1, le/ri	1.44.84.4080.00x		•
40×80, type 2, le/ri	1.44.84.4080.40x	•	
45×45, type 2, le/ri	1.44.84.4545.45x	•	
45×90, type 2, le/ri	1.44.84.4590.45x	•	
60×80, type 2, le/ri	1.44.84.6080.60x	•	

**Comments**

- Drilling depth min. 70 mm
- Plain washers for vertical alignment as required

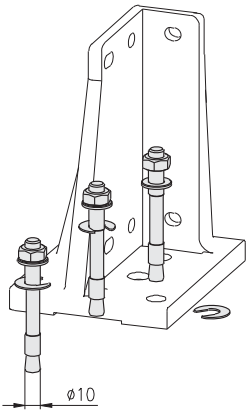

Description	Weight	Article-No.
Floor mounting set 3 MKT	202.3 g	1.44.83BB

Single parts	Pcs.	Weight	Article-No.
Pin anchor MKT, B10/20/95	3	65.3 g	0.66.MKT.B1020/95
Plain washer 1×Ø24/11	8	0.8 g	1.44.89011324

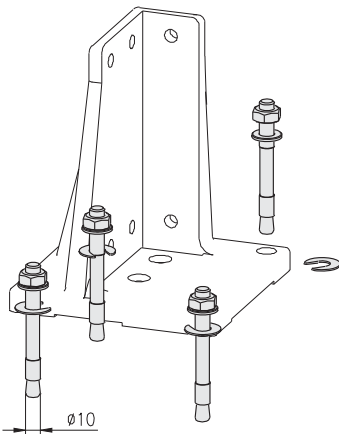

Description	Weight	Article-No.
Floor mounting set 4 MKT	269.2 g	1.44.84BB

Single parts	Pcs.	Weight	Article-No.
Pin anchor MKT, B10/20/95	4	65.3 g	0.66.MKT.B1020/95
Plain washer 1×Ø24/11	10	0.8 g	1.44.89011324

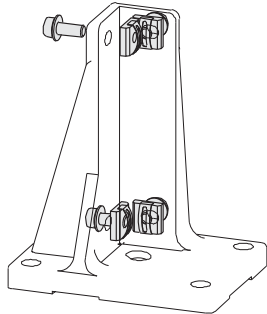
**Profile mounting sets**

**Application**

Suitable for mounting of the profiles:

- 40×40
- 45×45

Description	Weight	Article-No.
Profile mounting set 4 EM8	112.4 g	1.44.80BP40.20
Single parts	Pcs.	Weight
Threaded plate, heavy, E M8	4	16.3 g
Collar screw WN 251 M8×20	4	11.8 g

**Application**

Suitable for mounting of the profiles:

- 40×80
- 45×90
- 60×80, panel

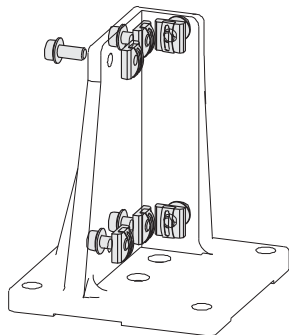

Description	Weight	Article-No.
Profile mounting set 6 EM8	168.6 g	1.44.80BP80.20
Single parts	Pcs.	Weight
Threaded plate, heavy, E M8	6	16.3 g
Collar screw WN 251 M8×20	6	11.8 g

Base angle



Application

For fastening of frames to floor or wall



Suitable for use together with levelling feet with max. diameter 100 mm

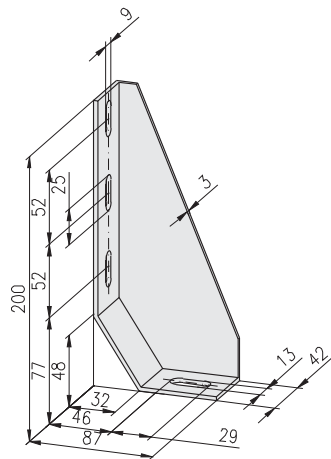

Technical data

material: sheet steel  
surface: galvanised and black coated

Comments

Picture shows base angle, left  
mirror-inverted: base angle, right

Description

Base angle 200×87×42, left  
Base angle 200×87×42, right

Weight Article-No.

Description	Weight	Article-No.
Base angle 200×87×42, left	413 g	1.44.820001L
Base angle 200×87×42, right	413 g	1.44.820001R

Stacking foot



Application

Element to fix 2 profiles in core hole

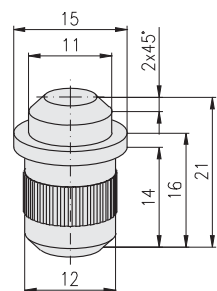
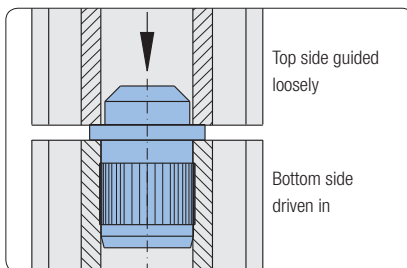

Technical data

material: steel  
surface: galvanised

Description

Stacking foot

Weight Article-No.

Description	Weight	Article-No.
Stacking foot	19 g	1.44.901221

Castors



Fastening in core hole



Fastening through base plate for profile without centric core hole

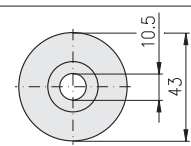
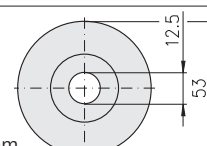
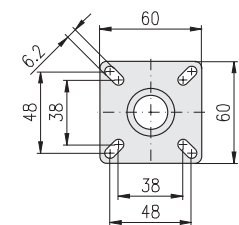
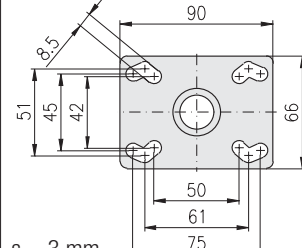

Fastening by press-fit threaded insert across the profile core hole

Variations		
Castor-Ø	50 mm / 75 mm	100 mm / 125 mm
Bolt hole type	 s = 7 mm	 s = 10.5 mm
Fitting plate type	 s = 2 mm	 s = 3 mm

Fixed castors



Technical data





material:

- capsule: sheet steel, galvanised
- wheels: solid rubber tyres, grey

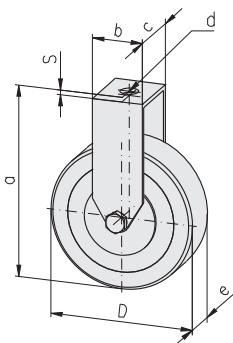
Ø75/100/125 incl. thread protection

max. static load:  $F_{max}$



Description	D	a	Weight	Article-No.
Fixed castor with bolt hole	Ø50	69	130 g	1.45.11050
Fixed castor with bolt hole	Ø75	98	240 g	1.45.11075
 Fixed castor with bolt hole, ESD	Ø75	98	240 g	1.45.11075E
Fixed castor with bolt hole	Ø100	133	500 g	1.45.11100
 Fixed castor with bolt hole, ESD	Ø100	133	500 g	1.45.11100E
Fixed castor with bolt hole	Ø125	158	900 g	1.45.11125
Fixed castor with fitting plate	Ø50	71	190 g	1.45.12050
Fixed castor with fitting plate	Ø75	100	300 g	1.45.12075
 Fixed castor with fitting plate, ESD	Ø75	100	300 g	1.45.12075E
Fixed castor with fitting plate	Ø100	136	610 g	1.45.12100
 Fixed castor with fitting plate, ESD	Ø100	136	610 g	1.45.12100E
Fixed castor with fitting plate	Ø125	161	1,010 g	1.45.12125

Dimensions see table on the right

Swivel castors



Technical data

material:

- capsule: sheet steel, galvanised
- wheels: solid rubber tyres, grey

Ø75/100/125 incl. thread protection

max. static load:  $F_{max}$

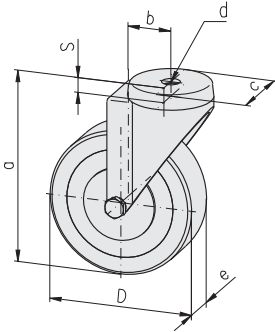

Description	D	a	Weight	Article-No.
Swivel castor with bolt hole	Ø50	69	180 g	1.45.21050
Swivel castor with bolt hole	Ø75	98	310 g	1.45.21075
Swivel castor with bolt hole, ESD	Ø75	98	310 g	1.45.21075E
Swivel castor with bolt hole	Ø100	133	680 g	1.45.21100
Swivel castor with bolt hole, ESD	Ø100	133	680 g	1.45.21100E
Swivel castor with bolt hole	Ø125	158	890 g	1.45.21125
Swivel castor with fitting plate	Ø50	71	230 g	1.45.22050
Swivel castor with fitting plate	Ø75	100	360 g	1.45.22075
Swivel castor with fitting plate, ESD	Ø75	100	360 g	1.45.22075E
Swivel castor with fitting plate	Ø100	136	780 g	1.45.22100
Swivel castor with fitting plate, ESD	Ø100	136	780 g	1.45.22100E
Swivel castor with fitting plate	Ø125	161	990 g	1.45.22125

Dimensions see table below

Swivel castors lockable



Technical data

material:

- capsule: sheet steel, galvanised
- wheels: solid rubber tyres, grey

stop fix: - wheel break  
- swivel break

Ø75/100/125 incl. thread protection

max. static load:  $F_{max}$

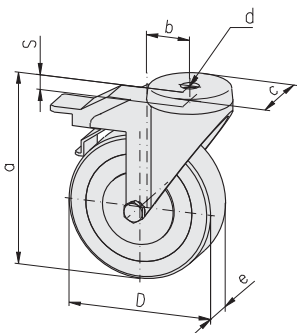

Description	D	a	Weight	Article-No.
Swivel castor, lockable with bolt hole	Ø50	69	220 g	1.45.31050
Swivel castor, lockable with bolt hole	Ø75	98	450 g	1.45.31075
Swivel castor, lockable with bolt hole, ESD	Ø75	98	450 g	1.45.31075E
Swivel castor, lockable with bolt hole	Ø100	133	840 g	1.45.31100
Swivel castor, lockable with bolt hole, ESD	Ø100	133	840 g	1.45.31100E
Swivel castor, lockable with bolt hole	Ø125	158	990 g	1.45.31125
Swivel castor, lockable with fitting plate	Ø50	71	270 g	1.45.32050
Swivel castor, lockable with fitting plate	Ø75	100	500 g	1.45.32075
Swivel castor, lockable with fitting plate, ESD	Ø75	100	500 g	1.45.32075E
Swivel castor, lockable with fitting plate	Ø100	136	940 g	1.45.32100
Swivel castor, lockable with fitting plate, ESD	Ø100	136	940 g	1.45.32100E
Swivel castor, lockable with fitting plate	Ø125	161	1,090 g	1.45.32125

Castors: Design bolt hole									
D	Fixed castor			Swivel castor			d	e	$F_{max}$
	b	c	s	b	c	s			
Ø50	30	27	2.0	25	Ø43	10.5	Ø10.5	18	400 N
Ø75	34	27	2.0	30.5	Ø43	10.5	Ø10.5	25	550 N
Ø100	57	43	2.5	43	Ø57	10.5	Ø12.5	32	800 N
Ø125	57	43	2.5	43	Ø57	10.5	Ø12.5	32	1,000 N



**Locking castors**



**Application**

Locking castors for easy movement and positioning of trolleys, benches and assemblies

**Technical data**

material:

- capsule: Al
- fastening elements: C45
- locking foot: GD-Al, rubber
- max. static load:  $F_{max}$

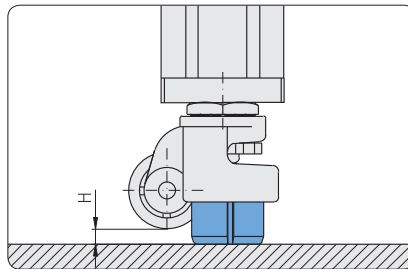

Extended support foot to secure position

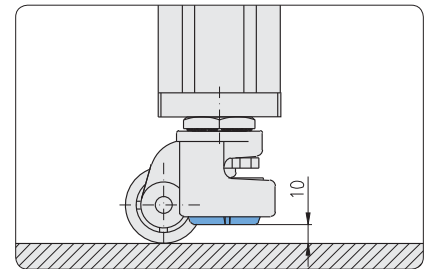

Retracted support foot for easy movement

Design					
D	a	b <sub>max</sub>	c	H <sub>max</sub>	F <sub>max</sub>
Ø50	84	90	98	6	2,500 N
Ø63	104	114	120	10	5,000 N

**Locking castors with plate**

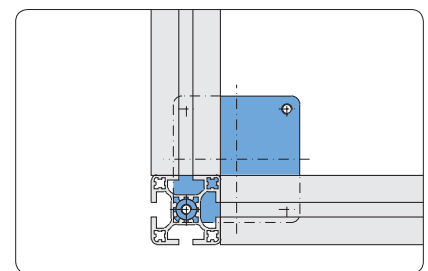
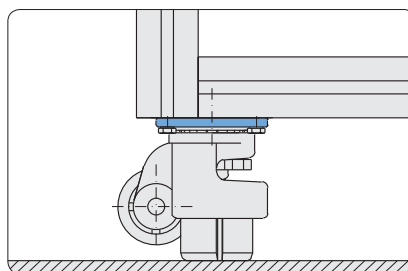

Mounting on profile frame using core hole and slot

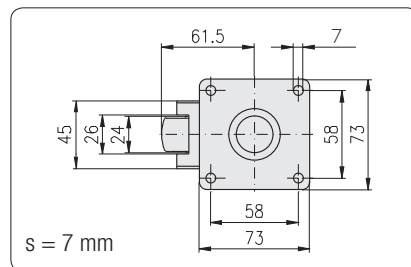

Castor-Ø50

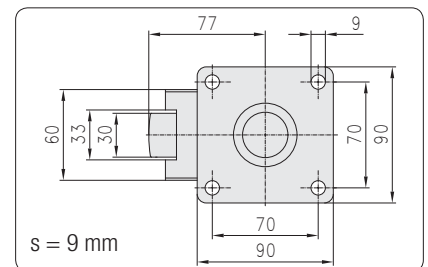

Castor-Ø63

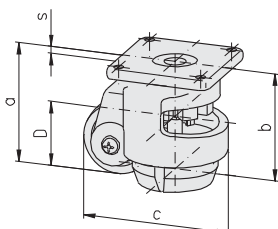

Description	D	Weight	Article-No.
Locking castor 250 kg, with plate	Ø50	700 g	1.45.80200.073
Locking castor 500 kg, with plate	Ø63	1,300 g	1.45.80400.090

**Locking castors with center thread**

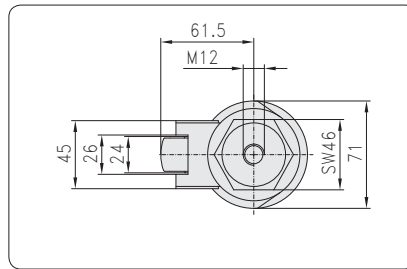
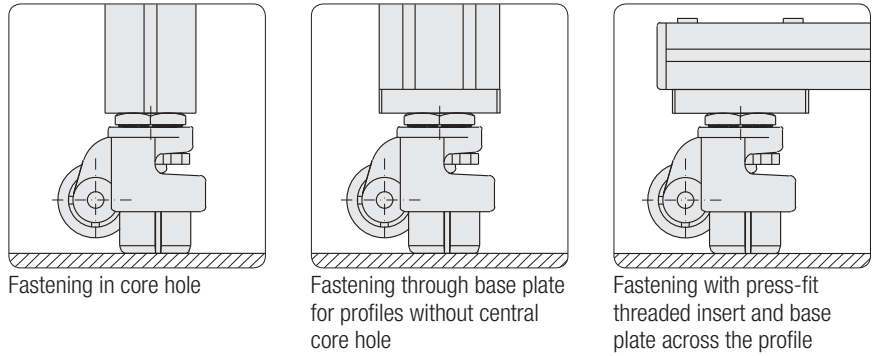

Castor-Ø50

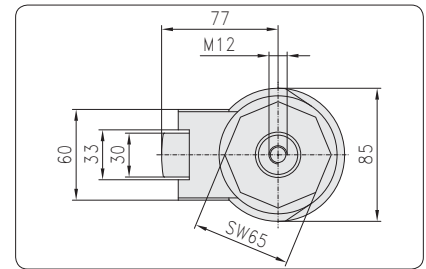

Castor-Ø63

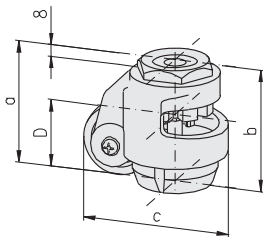

Description	D	Weight	Article-No.
Locking castor 250 kg, with center thread	Ø50	640 g	1.45.81200.046
Locking castor 500 kg, with center thread	Ø63	1,230 g	1.45.81400.065

**Threaded bolt for locking castor with center thread**

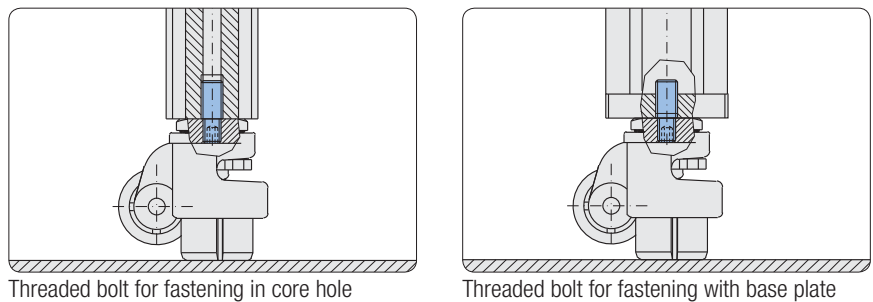

**Application**

- For fastening of locking castors with central thread
- in core hole-Ø12 of the profile
  - on base plate

**Technical data**

material: steel  
surface: galvanised

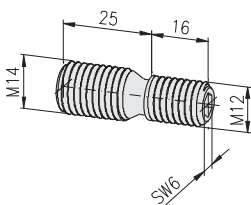

Description	Weight	Article-No.
Threaded bolt M12/M14	21 g	1.45.81000.M12M14

**Angles 25×40**



Fastening of panels

**Application**

Angle bracket for the mounting of panels, table tops, switches and accessories

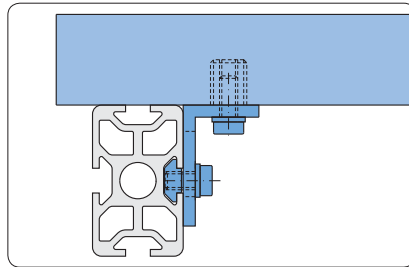

Fastening of table tops

**Technical data**

material: aluminium  
 strength: F22  
 surface: natural anodised

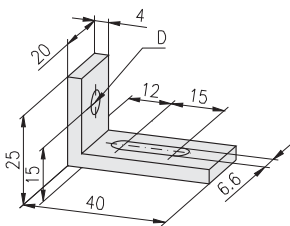

**Comments**

Design with clearance hole drilling

Description	D	Weight	Article-No.
Angle 25×40	Ø6.6	11 g	1.46.110
Angle 25×40	Ø8.7	10 g	1.46.115

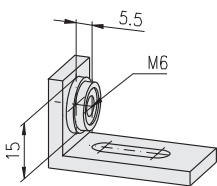

**Comments**

Design with nut M6 ± 0.5 mm floating in cage

Description	Weight	Article-No.
Angle 25×40, M6	15 g	1.46.120

**Angles PA**



Support of free-standing profiles

**Application**

For supporting of profiles and mounting of cover panels



Support across the profile  
In this application the rotary lock must be removed from one side



Mounting of cover panels  
In this application the rotary lock must be removed from both sides

**Technical data**

material: PA-GF

**20×28**

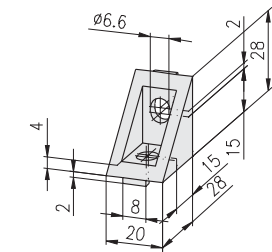

Description	Colour	Weight	Article-No.
Angle PA, 20×28	grey	6.4 g	1.46.203.2028.1
Angle PA, 20×28	black	6.4 g	1.46.203.2028.2

**30×38**

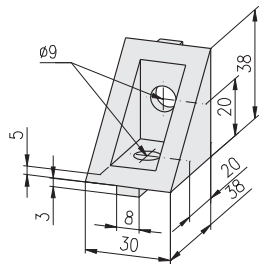

Description	Colour	Weight	Article-No.
Angle PA, 30×38	grey	18.9 g	1.46.203.3038.1
Angle PA, 30×38	black	18.9 g	1.46.203.3038.2

**Angles GD-Zn**

**Application**

For supporting profiles and mounting various machine components

**Technical data**

material:

- angle: GD-Zn
- cover cap: PA-GK 30
- T-slot nut: steel, galvanised
- screw: steel, galvanised
- surface: natural or aluminium coloured powder-coated

For mounting cross to the slot the noses can be broken off

□

- 1 angle natural
- 2 angle powder-coated

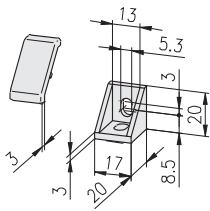
**17×20**

Description	Surface	Weight	Article-No.
Angle GD-Zn, 17×20	natural	13.7 g	1.46.204.1720.1
Angle GD-Zn, 17×20	powder-coated	13.7 g	1.46.204.1720.2
Cover cap for angle GD-Zn, 17×20		1.7 g	1.46.204.1720A
Angle connection set	1720 H/H	20.9 g	1.46.204.1720.□HH
Angle connection set	1720 H/F	23.6 g	1.46.204.1720.□HF
Angle connection set	1720 F/F	26.3 g	1.46.204.1720.□FF
Angle connection set	1720 T H/F	25.0 g	1.46.204.1720T□HF
Angle connection set	1720 T F/F	29.1 g	1.46.204.1720T□FF

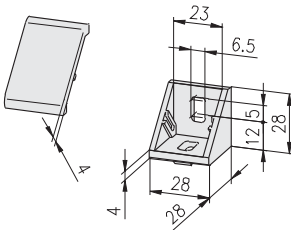
**28×28**

Description	Surface	Weight	Article-No.
Angle GD-Zn, 28×28	natural	39.6 g	1.46.204.2828.1
Angle GD-Zn, 28×28	powder-coated	39.6 g	1.46.204.2828.2
Cover cap for angle GD-Zn, 28×28		5.6 g	1.46.204.2828A
Angle connection set	2828 F/F	56.4 g	1.46.204.2828.□FF
Angle connection set	2828 F/E	56.8 g	1.46.204.2828.□FE
Angle connection set	2828 E/E	57.2 g	1.46.204.2828.□EE
Angle connection set	2828 T F/F	59.8 g	1.46.204.2828T□FF
Angle connection set	2828 T F/E	66.3 g	1.46.204.2828T□FE
Angle connection set	2828 T E/E	72.8 g	1.46.204.2828T□EE

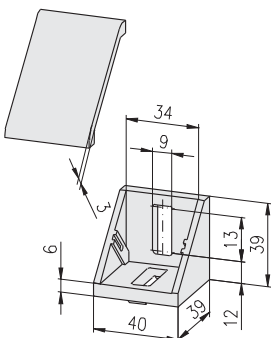
**40×39**

Description	Surface	Weight	Article-No.
Angle GD-Zn, 40×39	natural	85.5 g	1.46.204.4039.1
Angle GD-Zn, 40×39	powder-coated	85.5 g	1.46.204.4039.2
Cover cap for angle GD-Zn, 40×39		8.0 g	1.46.204.4039A
Angle connection set	4039 F/F	105.9 g	1.46.204.4039.□FF
Angle connection set	4039 F/E	111.9 g	1.46.204.4039.□FE
Angle connection set	4039 E/E	117.9 g	1.46.204.4039.□EE
Angle connection set	4039 T F/F	105.9 g	1.46.204.4039T□FF
Angle connection set	4039 T F/E	111.9 g	1.46.204.4039T□FE
Angle connection set	4039 T E/E	117.9 g	1.46.204.4039T□EE

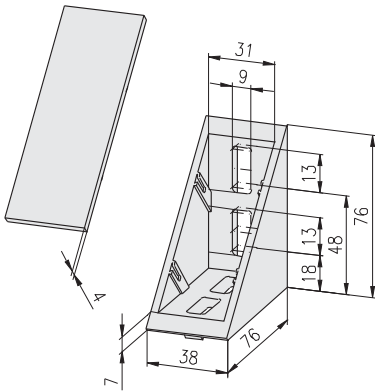
**38×76**



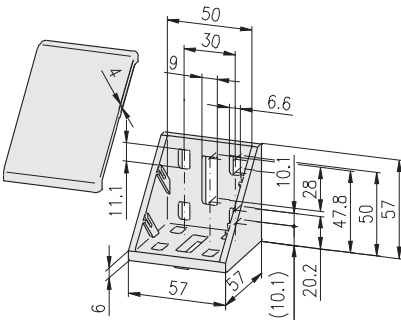

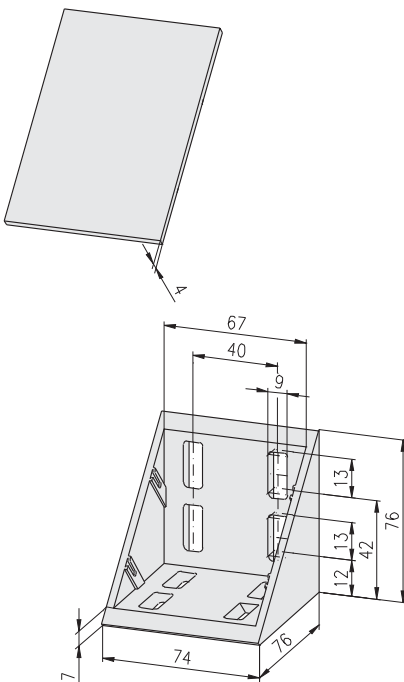

Description	Surface	Weight	Article-No.
Angle GD-Zn, 38×76	natural	273.0 g	1.46.204.3876.1
Angle GD-Zn, 38×76	powder-coated	273.0 g	1.46.204.3876.2
Cover cap for angle GD-Zn, 38×76		16.8 g	1.46.204.3876A
Angle connection set	3876 F/F	334.2 g	1.46.204.3876.□FF
Angle connection set	3876 F/E	342.2 g	1.46.204.3876.□FE
Angle connection set	3876 E/E	350.2 g	1.46.204.3876.□EE
Angle connection set	3876 T F/F	313.8 g	1.46.204.3876T□FF
Angle connection set	3876 T F/E	325.8 g	1.46.204.3876T□FE
Angle connection set	3876 T E/E	337.8 g	1.46.204.3876T□EE

**57×57**

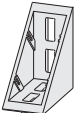

Description	Surface	Weight	Article-No.
Angle GD-Zn, 57×57	natural	226.3 g	1.46.204.5757.1
Angle GD-Zn, 57×57	powder-coated	226.3 g	1.46.204.5757.2
Cover cap for angle GD-Zn, 57×57		22.8 g	1.46.204.5757A
Angle connection set	5757 F/F	296.7 g	1.46.204.5757.□FF
Angle connection set	5757 F/E	280.8 g	1.46.204.5757.□FE
Angle connection set	5757 E/E	261.9 g	1.46.204.5757.□EE
Angle connection set	5757 T F/F	246.7 g	1.46.204.5757T□FF
Angle connection set	5757 T F/E	252.7 g	1.46.204.5757T□FE
Angle connection set	5757 T E/E	258.7 g	1.46.204.5757T□EE

**74×76**

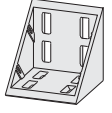
Description	Surface	Weight	Article-No.
Angle GD-Zn, 74×76	natural	434.5 g	1.46.204.7476.1
Angle GD-Zn, 74×76	powder-coated	434.5 g	1.46.204.7476.2
Cover cap for angle GD-Zn, 74×76		32.7 g	1.46.204.7476A
Angle connection set	7476 E/E	588.9 g	1.46.204.7476.□EE

Single Parts: Angle connection sets										
Angle	Set	Slot	Threaded plate	T-slot nut	T-nut for subsequent insertion	Lens head screw	T-screw	Hexagon flange nut	Pcs.	
	1720	H	H	1.31.4HM5			0.63.WN7381.05006		2	
		H	F	1.31.4HM5	1.34.10FM5		0.63.WN7381.05006 0.63.WN7381.05008		1 1	
		F	F		1.34.10FM5		0.63.WN7381.05008		2	
	1720 T	H	F	1.31.4HM5	1.32.4FM5		0.63.WN7381.05006 0.63.WN7381.05008		1 1	
		F	F		1.32.4FM5		0.63.WN7381.05008		2	
	2828	F	F		1.34.10FM6		0.63.WN7381.06010		2	
		F			1.34.10FM6		0.63.WN7381.06010		1	
		E	E		1.34.10EM6		0.63.WN7381.06012		1	
		E	E		1.34.10EM6		0.63.WN7381.06012		2	
	2828 T	F	F			1.32.4FM6	0.63.WN7381.06010			2
		F				1.32.4FM6	0.63.WN7381.06010			1
		E	E			1.32.4EM6	0.63.WN7381.06012			1
		E	E			1.32.4EM6	0.63.WN7381.06012			2
	4039	F	F				 1.34.FM82	0.61.D06923.08	2	
		F					1.34.FM82	0.61.D06923.08	1	
		E	E				1.34.EM82	0.61.D06923.08	1	
		E	E				1.34.EM82	0.61.D06923.08	2	
	4039 T	F	F			1.32.4FM8	0.63.WN7381.08012			2
		F				1.32.4FM8	0.63.WN7381.08012			1
		E	E			1.32.4EM8	0.63.WN7381.08016			1
		E	E			1.32.4EM8	0.63.WN7381.08016			2
	3876	F	F				1.34.FM82	0.61.D06923.08	4	
		F					1.34.FM82	0.61.D06923.08	2	
		E	E				1.34.EM82	0.61.D06923.08	2	
		E	E				1.34.EM82	0.61.D06923.08	4	
	3876 T	F	F			1.32.4FM8	0.63.WN7381.08012			4
		F				1.32.4FM8	0.63.WN7381.08012			2
		E	E			1.32.4EM8	0.63.WN7381.08016			2
		E	E			1.32.4EM8	0.63.WN7381.08016			4
	5757	F	F	1.34.10FM6		0.63.WN7381.06012			8	
		F		1.34.10FM6		0.63.WN7381.06012			4	
		E	E				1.34.EM82	0.61.D06923.08	1	
		E	E				1.34.EM82	0.61.D06923.08	2	
	5757 T	F	F			1.32.4FM6	0.63.WN7381.06012			8
		F				1.32.4FM6	0.63.WN7381.06012			4
		E	E			1.32.4EM8	0.63.WN7381.08016			1
		E	E			1.32.4EM8	0.63.WN7381.08016			2
	7476	E	E				1.34.EM82	0.61.D06923.08	8	

  
 1 angle natural  
 2 angle powder-coated

 Connection with T-screw only without cover cap

Angles GD-AI



Application

For supporting profiles and mounting various machine components

Technical data

material:

- angle: GD-AI
- cover cap: PA GK 30
  - nut: steel, galvanised
  - screw: steel, galvanised
- surface: natural

42×42

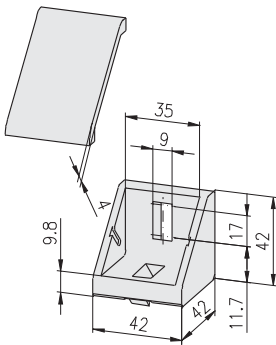

Description	Surface	Weight	Article-No.
Angle GD-AI, 42×42	natural	56.0 g	1.46.204.4242.1AL
Cover cap for angle GD-AI, 42×42		14.0 g	1.46.204.4242.AAL
Angle connection set	4242 E/E	100.0 g	1.46.204.4242.SAL

Single parts: Angle connection set 4242					
Angle	Slot	Fastening elements			
		T-screw		hexagon flange nut	Pcs.
1.46.204.4242.1AL	E E	1.34.EM825		0.61.D06923.08	2

88×86

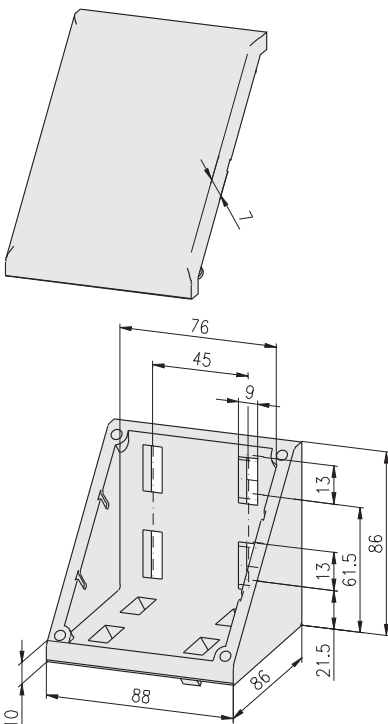

Description	Surface	Weight	Article-No.
Angle GD-AI, 88×86	natural	333.8 g	1.46.204.8886.1AL
Cover cap for angle GD-AI, 88×86		30.0 g	1.46.204.8886.AAL
Angle connection set	8886 E/E	485.5 g	1.46.204.8886.SAL

Single parts: Angle connection set 8886					
Angle	Slot	Fastening elements			
		T-screw		hexagon flange nut	Pcs.
1.46.204.8886.1AL	E E	1.34.EM825		0.61.D06923.08	8



**Angles Alu**



Mounting of cover panels

**Application**

For supporting of profiles and mounting of cover panels



Support across the profile



Support of free-standing profiles

**Technical data**

material: aluminium  
 strength: F25  
 surface: natural anodised

**Comments**

raw finish on request

**48×48**

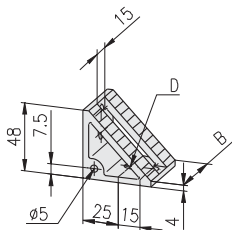

Description	D	B	Weight	Article-No.
Angle 48×48	Ø6.6	30	40 g	1.46.20536
Angle 48×48	Ø9.0	30	38 g	1.46.20539
Angle 48×48	Ø6.6	45	66 g	1.46.20546
Angle 48×48	Ø9.0	45	64 g	1.46.20549

**60×60**

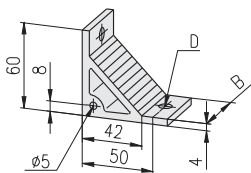

Description	D	B	Weight	Article-No.
Angle 60×60	Ø9.0	30	49 g	1.46.20639
Angle 60×60	Ø9.0	45	74 g	1.46.20649

**97×97**

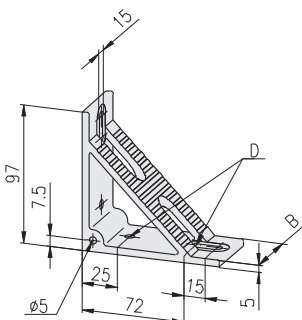

Description	D	B	Weight	Article-No.
Angle 97×97	Ø6.6	30	95 g	1.46.21036
Angle 97×97	Ø9.0	30	93 g	1.46.21039
Angle 97×97	Ø6.6	45	155 g	1.46.21046
Angle 97×97	Ø9.0	45	153 g	1.46.21049

Swivel angles



Fastening from below



Fastening from the side

**Application**

Infinitely variable adjusting of inclination with swivel angle

**Technical data**

Design alu:

- material: aluminium
- strength: F22
- surface: natural anodised

Design steel:

- material: steel
- surface: galvanised

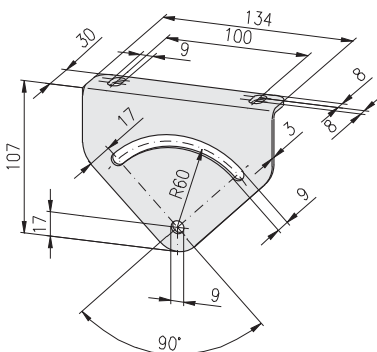
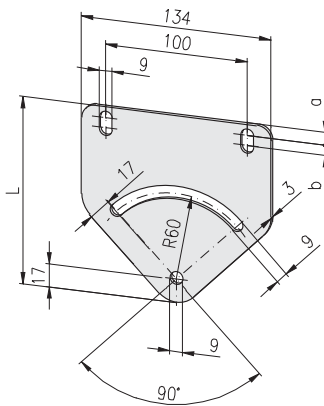

- 16 20 30 40 45 50 60

Description	L	Design	a	b	Weight	Article-No.
Swivel angle	131	alu	8	8.0	105 g	1.46.3013100.AL
Swivel angle	146	alu	13	10.5	116 g	1.46.3014600.AL
Swivel angle	131	steel	8	8.0	320 g	1.46.3013100.ST
Swivel angle	146	steel	13	10.5	360 g	1.46.3014600.ST

Description	Design	Weight	Article-No.
Swivel angle 30	alu	105 g	1.46.3110530.AL
Swivel angle 30	steel	320 g	1.46.3110530.ST

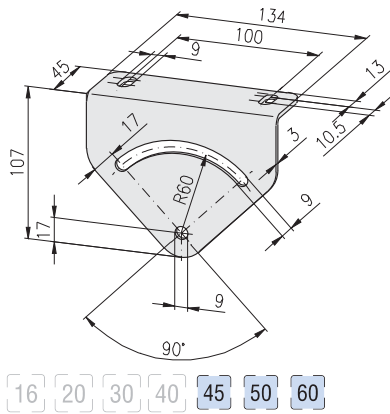

Description	Design	Weight	Article-No.
Swivel angle 45	alu	116 g	1.46.3110545.AL
Swivel angle 45	steel	360 g	1.46.3110545.ST

### Cross connection plates

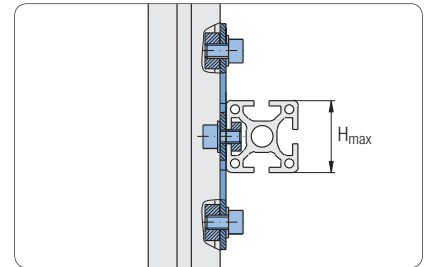
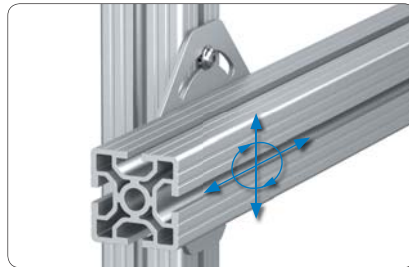

#### Application

The cross connection plate allows profile adjustment in 2 directions and at an angle of  $\pm 45^\circ$

#### Technical data

material: aluminium  
 strength: F22  
 surface: natural anodised

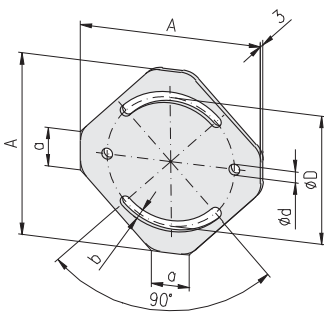

Description	H <sub>max</sub>	Weight	Article-No.
Cross connection plate 65×65	20	20 g	1.47.1065
Cross connection plate 85×85	30	35 g	1.47.1085
Cross connection plate 95×95	30	45 g	1.47.1095
Cross connection plate 125×125	50	80 g	1.47.1125

Type	A	a	b	ØD	Ød
65×65	65	18	5.1	45	5.1
85×85	85	18	5.1	60	5.1
95×95	95	18	6.1	65	6.1
125×125	125	37	8.1	95	8.1

Base plates



Fastening of levelling feet

Application

Base and transporting plate for profiles without centric core hole



Fastening of castors



Fastening of eye-bolts

Technical data

Design Alu:

- material: aluminium
- strength: F22
- surface: black powder-coated

Design GD-Zn:

- material: GD-Zn
- surface: black powder-coated

Accessories

- threaded insert
- cap-screw DIN 912

Comments

Counterbore DIN 74 for cap-screw DIN 912

Variants

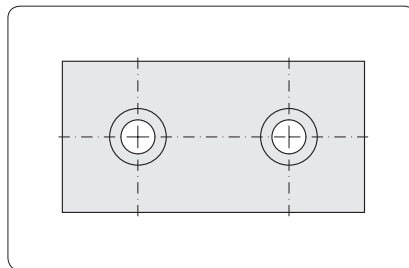

without thread

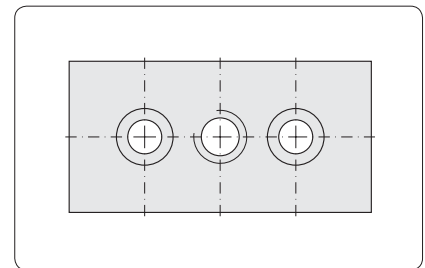

with thread

Dimensions	without thread			with thread M14		
	B×L	Design	h	Article-No.	Design	h
30×60	Alu	15	1.47.2030060.0600.1	GD-Zn	12	1.47.20306
40×80	Alu	15	1.47.2040080.0800.1	GD-Zn	16	1.47.20408
45×90	Alu	15	1.47.2045090.0800.1	GD-Zn	16	1.47.2045090
50×100	Alu	15	1.47.2050100.0800.1	GD-Zn	16	1.47.20510
50×150	Alu	15	1.47.2050150.0800.1			
60×60	Alu	15	1.47.2060060.0800.1	GD-Zn	12	1.47.2060060
80×80	Alu	15	1.47.2080080.0800.1	GD-Zn	16	1.47.20808
90×90	Alu	15	1.47.2090090.0800.1	GD-Zn	16	1.47.2090090
100×100	Alu	15	1.47.2100100.0800.1	GD-Zn	16	1.47.21010

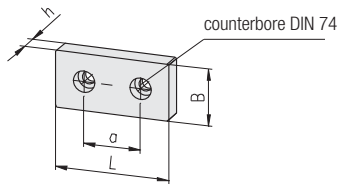
**Base plates**  
 without thread

16 20 30 40 45 50 60

Description	B×L	Design	DIN 74	h	a	Weight	Article-No.
Base plate w/o thread	30×60	Alu	- Km6	15	30	64 g	1.47.2030060.0600.1
Base plate w/o thread	40×80	Alu	- Km8	15	40	114 g	1.47.2040080.0800.1
Base plate w/o thread	45×90	Alu	- Km8	15	45	148 g	1.47.2045090.0800.1
Base plate w/o thread	50×100	Alu	- Km8	15	50	186 g	1.47.2050100.0800.1

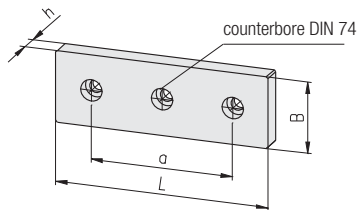

16 20 30 40 45 50 60

Description	B×L	Design	DIN 74	h	a	Weight	Article-No.
Base plate w/o thread	50×150	Alu	- Km8	15	100	280 g	1.47.2050150.0800.1

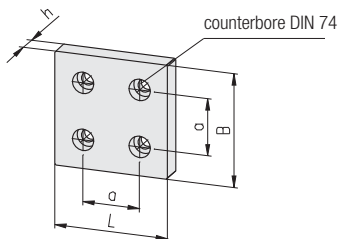

16 20 30 40 45 50 60

Description	B×L	Design	DIN 74	h	a	Weight	Article-No.
Base plate w/o thread	60×60	Alu	- Km8	15	30	115 g	1.47.2060060.0800.1
Base plate w/o thread	80×80	Alu	- Km8	15	40	228 g	1.47.2080080.0800.1
Base plate w/o thread	90×90	Alu	- Km8	15	45	297 g	1.47.2090090.0800.1
Base plate w/o thread	100×100	Alu	- Km8	15	50	374 g	1.47.2100100.0800.1

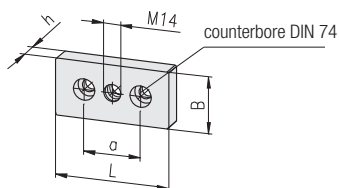
**Base plates**  
 with thread

16 20 30 40 45 50 60

Description	B×L	Design		h	a	Weight	Article-No.
Base plate	30×60	GD-Zn	M14 M6	12	30	104.2 g	1.47.20306
Base plate	40×80	GD-Zn	M14 M8	16	40	205.2 g	1.47.20408
Base plate	45×90	GD-Zn	M14 M8	16	45	256.5 g	1.47.2045090
Base plate	50×100	GD-Zn	M14 M8	16	50	316.8 g	1.47.20510

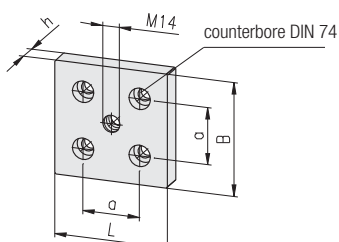

16 20 30 40 45 50 60

Description	B×L	Design		h	a	Weight	Article-No.
Base plate	60×60	GD-Zn	M14 M8	12	30	158.4 g	1.47.2060060
Base plate	80×80	GD-Zn	M14 M8	16	40	434.3 g	1.47.20808
Base plate	90×90	GD-Zn	M14 M8	16	45	520.7 g	1.47.2090090
Base plate	100×100	GD-Zn	M14 M8	16	50	601.0 g	1.47.21010

Floor mounting plate



**Application**

For fastening and manual levelling of profile racks and frames

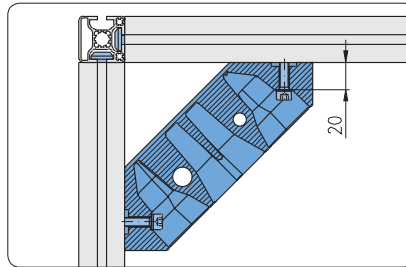

**Technical data**

material: aluminium  
 surface: natural or black powder-coated

**Fastening elements**

- F-slot: 2× T-nut with leaf spring FM8      1.32.FM8  
           2× cap screw M8×25
- E-slot: 2× threaded plate, heavy EM8      1.31.6EM8  
           2× cap screw M8×30

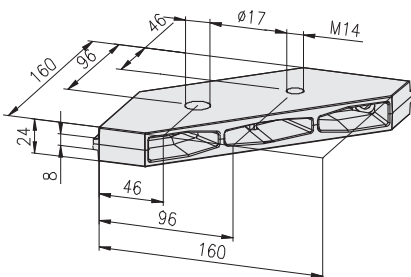

**Description**

Description	Weight	Article-No.
Floor mounting plate, natural	622 g	1.47.225160.1
Floor mounting plate, black powder-coated	622 g	1.47.225160.2

Mounting plates

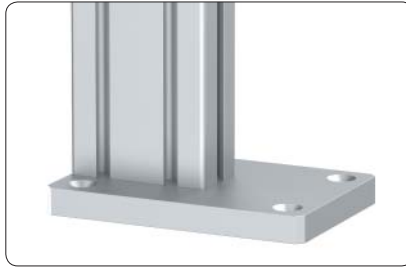

Application

Mounting plate for fixing on walls, table tops and machine frames

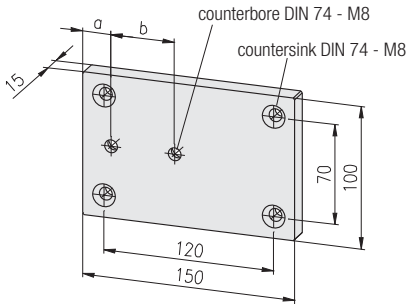

Technical data

material: aluminium  
strength: F22  
surface: natural anodised

Comments

Counterbore DIN 74 - M8 for cap-screw DIN 912 - M8  
Countersink DIN 74 - M8 for countersunk screw DIN 7991 - M8

- 16
- 20
- 30
- 40
- 45
- 50
- 60

Description

	a	b	Weight	Article-No.
Mounting plate for profile 30×60	15	30	450 g	1.47.30306
Mounting plate for profile 40×80	20	40	450 g	1.47.30408
Mounting plate for profile 50×100	25	50	450 g	1.47.30510

Floor plate

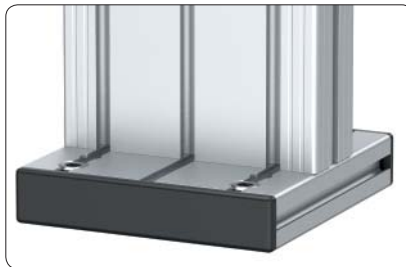

Application

For fastening and adjusting of vertical profiles to floor and wall

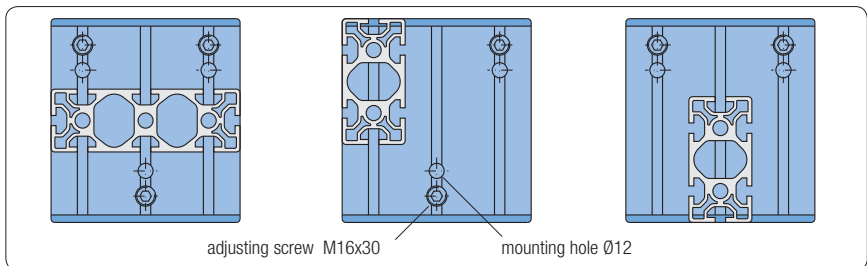
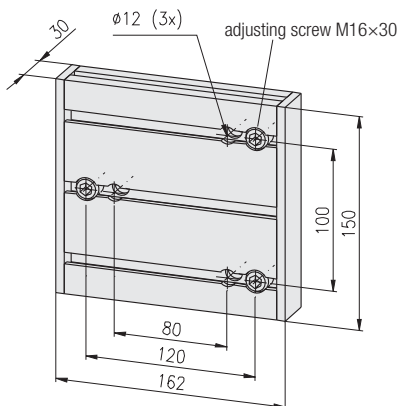

Fastening variants

Technical data

aluminium profile: anodised  
cover caps: PA-GF black

Delivery unit:

- 1 profile 30×150×150
- 2 cover caps
- 3 set screws M16×30

- 16
- 20
- 30
- 40
- 45
- 50
- 60

Description

	Weight	Article-No.
Floor plate 30×150×150	1,100 g	1.47.40315

Connection plates

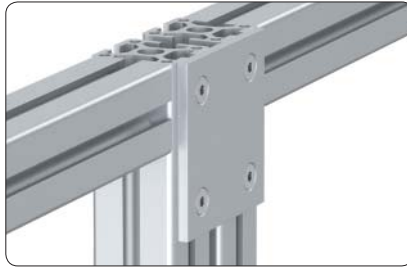

Flush connection of 2 profiles without gap



Connection of 2 profiles with gap



Fastening of the electrical trunking



Connection of the pneumatic air manifold

Application

- for subsequent or additional connection of profiles
- for fastening of accessories

Technical data

material: aluminium  
 strength: F22  
 surface: natural anodised

Comments

Countersink DIN 74 - M6 / M8 for  
 countersunk screw DIN 7991 - M6 / M8

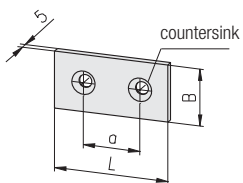

- 16 20 30 40 45 50 60

Description	B×L	Countersink	a	Weight	Article-No.
Connection plate	30×60	DIN 74 - M6	30	28 g	1.47.50306
Connection plate	40×80	DIN 74 - M8	40	38 g	1.47.50408
Connection plate	45×90	DIN 74 - M8	45	45 g	1.47.50459

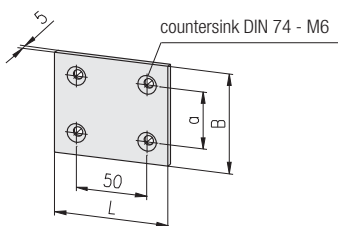

- 16 20 30 40 45 50 60

Comments

Countersink DIN 74 - M6 for  
 countersunk screw DIN 7991 - M6

Description	B×L	a	Weight	Article-No.
Connection plate	50×80	30	50 g	1.47.50508
Connection plate	70×80	40	69 g	1.47.50708
Connection plate	75×80	45	76 g	1.47.50758
Connection plate	80×80	50	81 g	1.47.50808



**Fastening plate  
30×150**

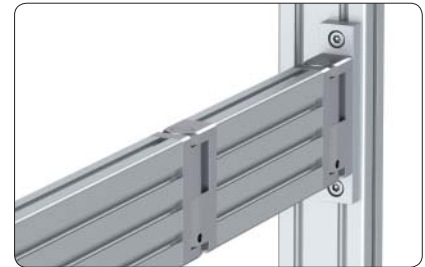
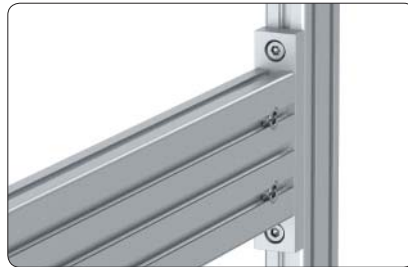

Fastening of profile 30×100

Fastening of profile 30×100 with joint  
30×100



**Application**

Fastening plate to increase the carrying capacity of detached bracket or swivel arm

- for profile 30×100
- for joint 30×100

**Technical data**

material: aluminium  
strength: F22  
surface: natural anodised

max. bend-load: $M_b = F \times L$	
vertical profiles	$M_b$
30×30	750 Nm
40×40	1,000 Nm
50×50	1,500 Nm

**Comments**

Counterbore DIN 74 - M8  
cap-screw DIN 6912 - M8

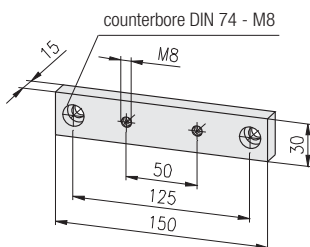

- 16 20 **30** 40 45 50 60

**Description**

Fastening plate 30×150

**Weight**

228 g

**Article-No.**

1.47.60315

Eye-bolt



Mounting directly in the profile (core hole)



Mounting with base plates

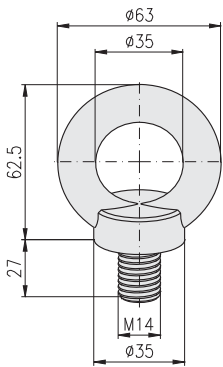

**Application**

Eye-bolts for the transfer of frames and complete equipment

**Technical data**

material: C 15

max. load 1):

- for one eye-bolt 5,000 N
- for two eye-bolts total 7,000 N

1) The max. load given is valid only if the eye-bolt face is tightened firmly

**Description**

Eye-bolt M14

**Weight**

193 g

**Article-No.**

1.47.96314

Corner pieces

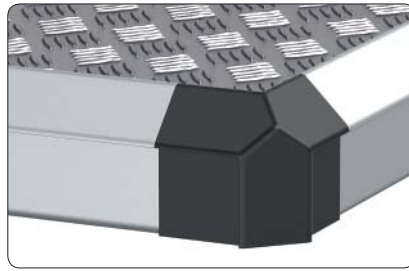

Application

Corner piece set angle PA for the connection of panel bezel profiles 40x40, 2E, 45°, SP

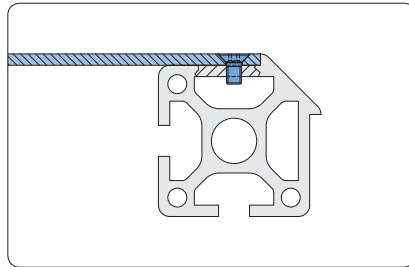

Assembly possibility

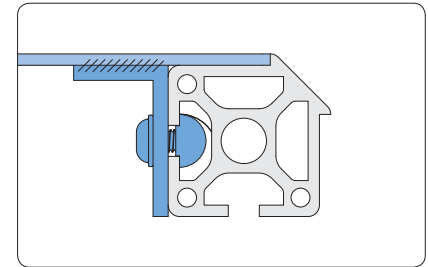

Assembly possibility

Corner angle

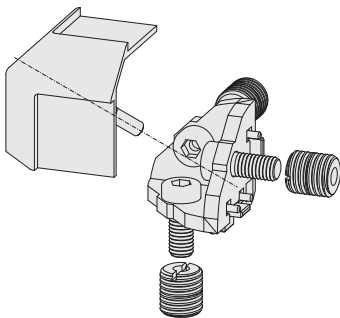

Technical data

- Cover cap:  
material: PA, black
- Angle:  
material: GD-Zn

Delivery unit (set)

- Corner piece angle
- Corner piece cover cap
- Threaded insert M14/M8 (3 pcs)
- Cap head screw (3 pcs)

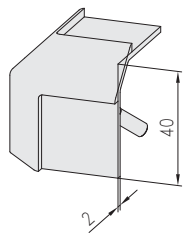

Description	Weight	Article-No.
Corner piece set angle PA	133.0 g	1.48.14340

Description	Weight	Article-No.
Corner piece cover cap, angle PA	12.5 g	1.48.14342

Label bar



Recess can also be used for label bars / label strips

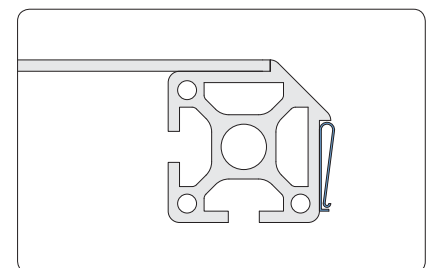

Corner pieces

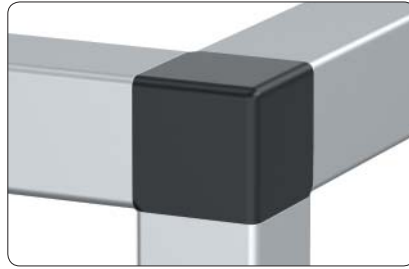

Corner piece set cubic PA: For the connection of three profiles 40×40

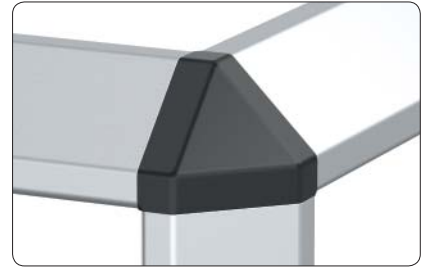

Corner piece set 45° PA: For the connection of three profiles 40×40, 2E, 45°, LP

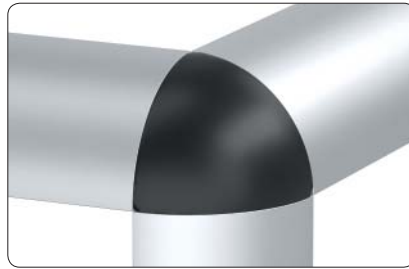

Corner piece set spherical PA: For the connection of three profiles 40×40, soft

**Technical data**

- Cover cap:  
material: PA, black
- Angle:  
material: GD-Zn

**Delivery unit (set)**

- Corner piece angle
- Corner piece cover cap
- Threaded insert M14/M8 (3 pcs)
- Cap head screw (3 pcs)

Cubic

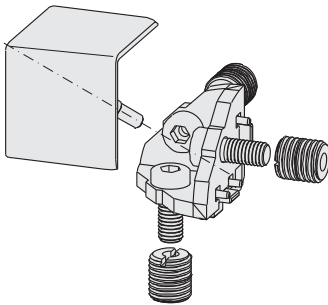

16 20 30 40 45 50 60

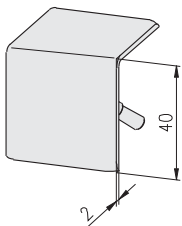

**Description**

Corner piece set cubic PA

**Weight**

136.0 g

**Article-No.**

1.48.14410

**Description**

Corner piece cover cap, cubic PA

**Weight**

15.5 g

**Article-No.**

1.48.14412

45°

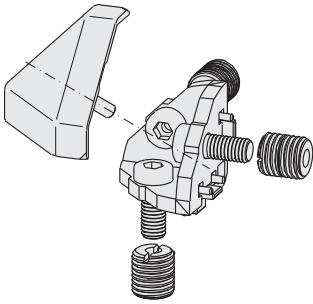

16 20 30 40 45 50 60

Description	Weight	Article-No.
Corner piece set 45° PA	128.0 g	1.48.14440

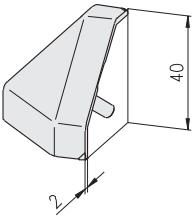

Description	Weight	Article-No.
Corner piece cover cap, 45° PA	7.5 g	1.48.14442

Spherical

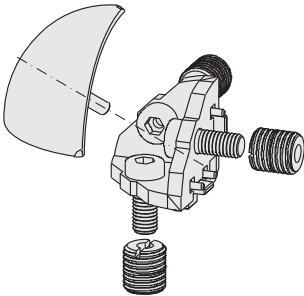

16 20 30 40 45 50 60

Description	Weight	Article-No.
Corner piece set spherical PA	129.0 g	1.48.14480

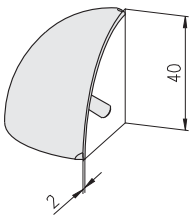

Description	Weight	Article-No.
Corner piece cover cap, spherical PA	8.5 g	1.48.14482

Corner pieces



Corner pieces cubic:  
Corner piece for the connection of 3 square profiles



Corner pieces segment:  
Corner piece for the connection of 2 square profiles and 1 soft profile

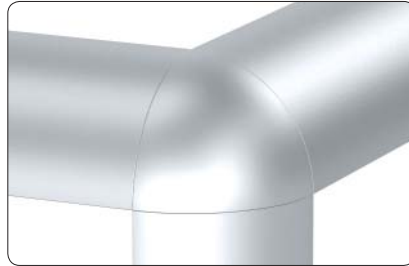

Corner pieces sphere:  
Corner piece for the connection of 3 soft profiles

**Technical data**

material: aluminium  
strength: F22  
surface: natural anodised

**General**

The attractive corner pieces are made of solid aluminium and guarantee the entire connection stability

Connection with corner pieces

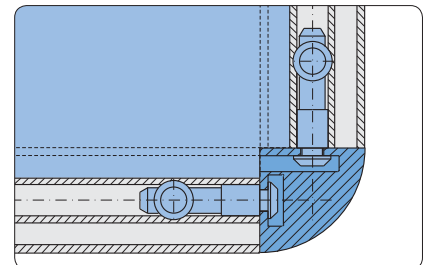

Connection of profiles with one corner piece using the standard connector

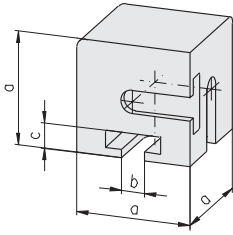
**Corner pieces cubic**

16 20 30 40 45 50 60

Description	a	Slot	b	c	Weight	Article-No.
Corner piece cubic	20	H	6.2	4.6	17 g	1.48.221
Corner piece cubic	30	F	8.2	6.2	59 g	1.48.331
Corner piece cubic	40	E3	8.2	9.0	135 g	1.48.441

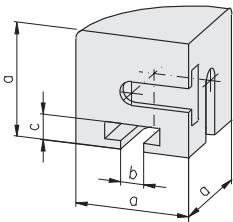
**Corner pieces segment**

16 20 30 40 45 50 60

Description	a	Slot	b	c	Weight	Article-No.
Corner piece segment	20	H	6.2	4.6	12 g	1.48.222
Corner piece segment	30	F	8.2	6.2	43 g	1.48.332
Corner piece segment	40	E3	8.2	9.0	100 g	1.48.442

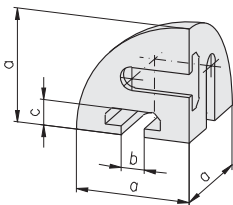

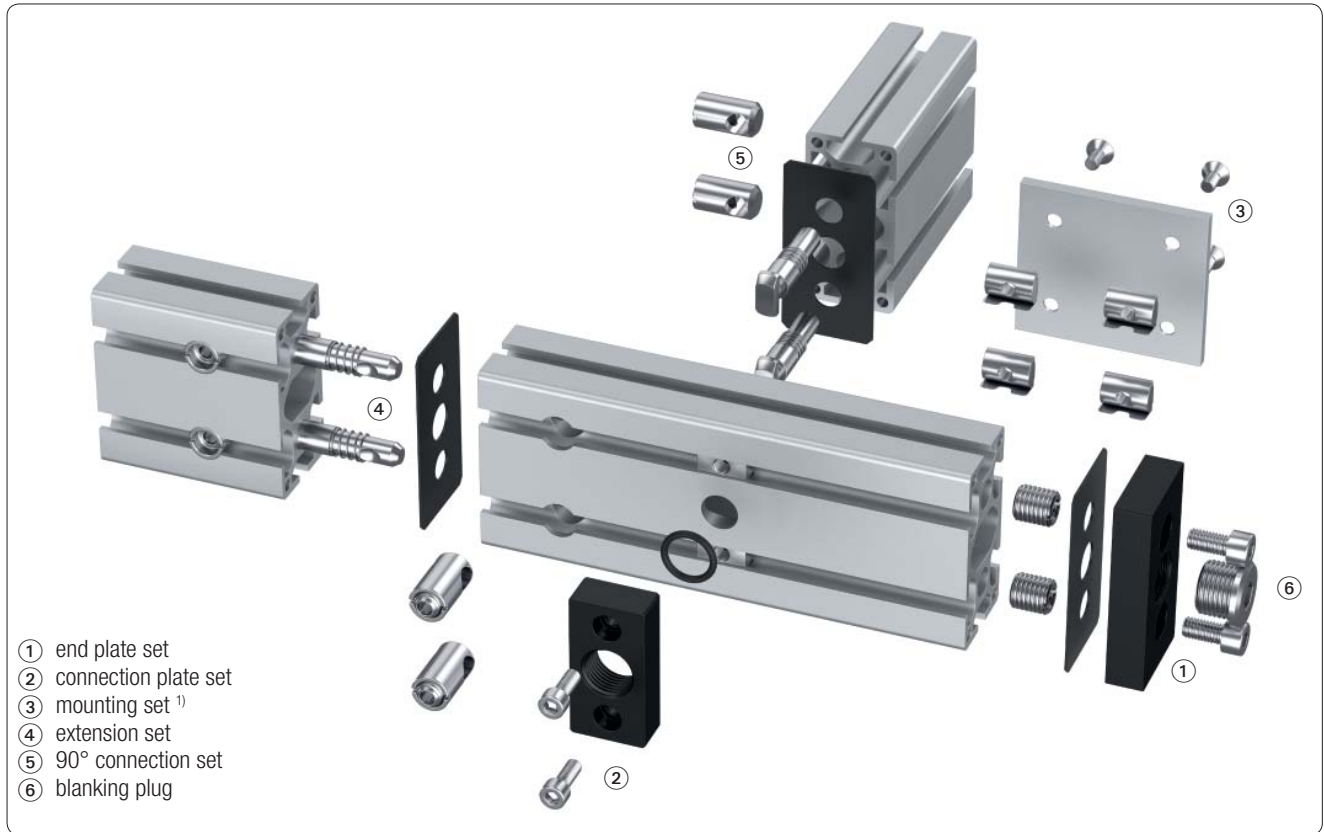

**Corner pieces sphere**

16 20 30 40 45 50 60

Description	a	Slot	b	c	Weight	Article-No.
Corner piece sphere	20	H	6.2	4.6	7 g	1.48.228
Corner piece sphere	30	F	8.2	6.2	24 g	1.48.338
Corner piece sphere	40	E3	8.2	9.0	57 g	1.48.448

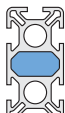

<sup>1)</sup> for mounting set → connection plate 1.47.50...

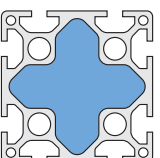
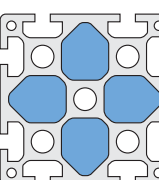
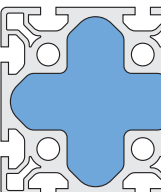
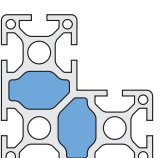
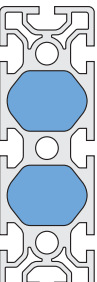
PG 30	PG 40	PG 45	PG 50	PG 60
 Profile 30×60, 6F <sup>2)</sup> 299.8 mm <sup>2</sup>	 Profile 40×80, 6E <sup>2)</sup> 521.8 mm <sup>2</sup>	 Profile 45×90, 6E <sup>2)</sup> 816.2 mm <sup>2</sup>	 Profile 50×100, 6E <sup>2)</sup> 1,043.3 mm <sup>2</sup>	 Profile 60×90, 6E <sup>2)</sup> 1,203.0 mm <sup>2</sup>
	 Profile 80×80, 8E <sup>2)</sup> 2,454.1 mm <sup>2</sup>	 Profile 90×90, 8E <sup>2)</sup> 635.2 mm <sup>2</sup> (4×)	 Profile 100×100, 8E <sup>2)</sup> 4,080.4 mm <sup>2</sup>	
	 Profile 80×80, 8E, angle <sup>2)</sup> 505.7 mm <sup>2</sup> (2×)		 Profile 50×150, 8E <sup>2)</sup> 1,115.8 mm <sup>2</sup> (2×)	<div style="border: 1px solid gray; padding: 5px;"> <p><b>Comments</b>                      Any profile with closed interior chambers can also be used as pressure line                       max. pressure: 10 bar</p> </div>

<sup>2)</sup> (pneumatic) cross-sectional area



Pneumatic end plates



**Application**

- for the closing of profile ends
- vent disconnection thread

**Comments**

Blanking plug and reducing nipple  
 ↗ Pneumatic accessories 1.59  
 Article-No. 1.59.010□□ and  
 1.59.020□□



**Technical data**

End plate

- material: aluminium
- strength: F22
- surface: black powder-coated

Seal

- material: NBR

**Comments**

Counterbore DIN 74 - M6 / M8 for  
 cap-screw DIN 912 - M6 / M8

Variants

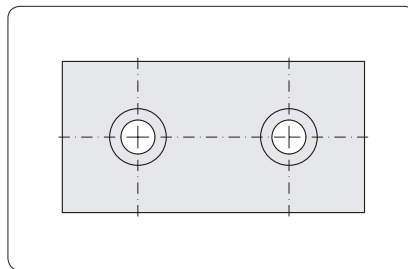

without thread

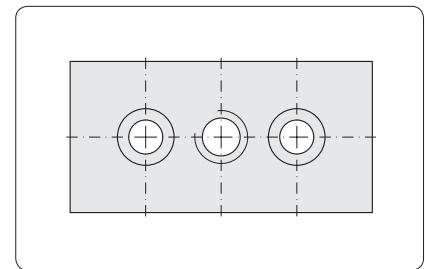

with thread

Dimensions	without thread	with thread G1/4"	with thread G1/2"
B×L	Article-No.	Article-No.	Article-No.
30×60	1.47.2030060.0600.1	1.51.13061	
40×80	1.47.2040080.0800.1		1.51.14081
45×90	1.47.2045090.0800.1		1.51.14591
50×100	1.47.2050100.0800.1		1.51.15101
50×150	1.47.2050150.0800.1		1.51.15151
80×80	1.47.2080080.0800.1		1.51.18081
100×100	1.47.2100100.0800.1		1.51.20101

**Pneumatic end plate sets**  
 without thread

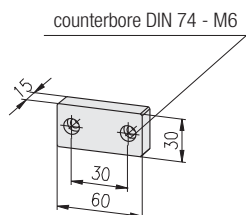
**30×60**

Description	Weight	Article-No.
Pneumatic end plate set w/o thread 30×60	121 g	1.50.2030060.0600.0
<b>Single parts</b>		
	<b>Pcs.</b>	
Base plate w/o thread 30×60	1	64 g 1.47.2030060.0600.1
Pneumatic seal 30×60	1	3 g 1.51.13062
Threaded insert M14/M6	2	22 g 1.35.1140615
Cap-screw DIN 912 - M6×16	2	5 g 0.63.D00912.06016

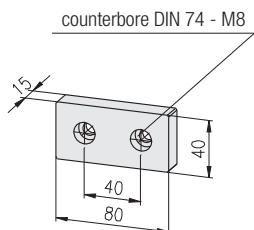
**40×80**

Description	Weight	Article-No.
Pneumatic end plate set w/o thread 40×80	173 g	1.50.2040080.0800.0
<b>Single parts</b>		
	<b>Pcs.</b>	
Base plate w/o thread 40×80	1	114 g 1.47.2040080.0800.1
Pneumatic seal 40×80	1	5 g 1.51.14082
Threaded insert M14/M8	2	18 g 1.35.1140815
Cap-screw DIN 912 - M8×16	2	9 g 0.63.D00912.08016

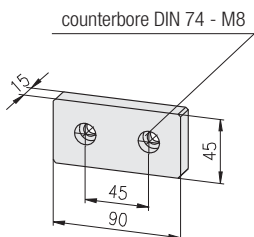
**45×90**

Description	Weight	Article-No.
Pneumatic end plate set w/o thread 45×90	208 g	1.50.2045090.0800.0
<b>Single parts</b>		
	<b>Pcs.</b>	
Base plate w/o thread 45×90	1	148 g 1.47.2045090.0800.1
Pneumatic seal 45×90	1	6 g 1.51.14592
Threaded insert M14/M8	2	18 g 1.35.1140815
Cap-screw DIN 912 - M8×16	2	9 g 0.63.D00912.08016

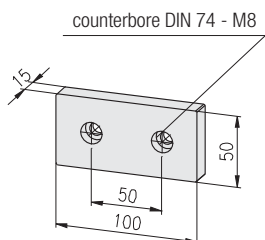
**50×100**

Description	Weight	Article-No.
Pneumatic end plate set w/o thread 50×100	247 g	1.50.2050100.0800.0
<b>Single parts</b>		
	<b>Pcs.</b>	
Base plate w/o thread 50×100	1	186 g 1.47.2050100.0800.1
Pneumatic seal 50×100	1	7 g 1.51.15102
Threaded insert M14/M8	2	18 g 1.35.1140815
Cap-screw DIN 912 - M8×16	2	9 g 0.63.D00912.08016

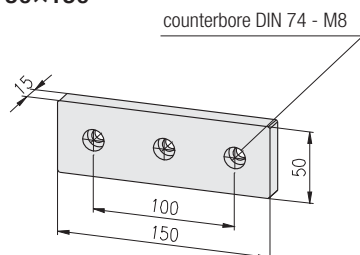
**50×150**

Description	Weight	Article-No.
Pneumatic end plate set w/o thread 50×150	371 g	1.50.2050150.0800.0
<b>Single parts</b>		
	<b>Pcs.</b>	
Base plate w/o thread 50×150	1	280 g 1.47.2050150.0800.1
Pneumatic seal 50×150	1	10 g 1.51.15152
Threaded insert M14/M8	3	18 g 1.35.1140815
Cap-screw DIN 912 - M8×16	3	9 g 0.63.D00912.08016

**Pneumatic end plate sets**  
 without thread

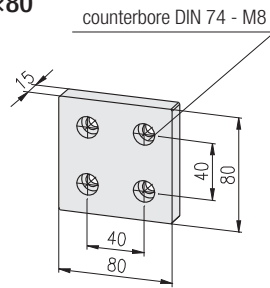
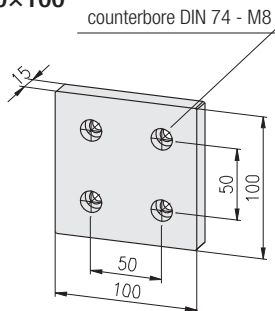
**80×80**

**100×100**

Description	Weight	Article-No.
Pneumatic end plate set w/o thread 80×80	343 g	1.50.2080080.0800.0

Single parts	Pcs.	Weight	Article-No.
Base plate w/o thread 80×80	1	228 g	1.47.2080080.0800.1
Pneumatic seal 80×80	1	7 g	1.51.18082
Threaded insert M14/M8	4	18 g	1.35.1140815
Cap-screw DIN 912 - M8×16	4	9 g	0.63.D00912.08016

Description	Weight	Article-No.
Pneumatic end plate set w/o thread 100×100	494 g	1.50.2100100.0800.0

Single parts	Pcs.	Weight	Article-No.
Base plate w/o thread 100×100	1	374 g	1.47.2100100.0800.1
Pneumatic seal 100×100	1	12 g	1.51.20102
Threaded insert M14/M8	4	18 g	1.35.1140815
Cap-screw DIN 912 - M8×16	4	9 g	0.63.D00912.08016

**Pneumatic end plate sets**  
with thread

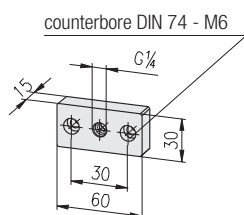
**30×60**

Description	Weight	Article-No.
Pneumatic end plate set 30×60	110 g	1.51.13060
<b>Single parts</b>		
Pneumatic end plate 30×60	1	53 g 1.51.13061
Pneumatic seal 30×60	1	3 g 1.51.13062
Threaded insert M14/M6	2	22 g 1.35.1140615
Cap-screw DIN 912 - M6×16	2	5 g 0.63.D00912.06016

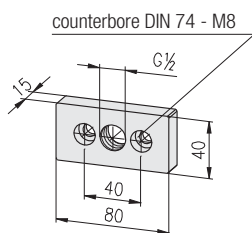
**40×80**

Description	Weight	Article-No.
Pneumatic end plate set 40×80	153 g	1.51.14080
<b>Single parts</b>		
Pneumatic end plate 40×80	1	94 g 1.51.14081
Pneumatic seal 40×80	1	5 g 1.51.14082
Threaded insert M14/M8	2	18 g 1.35.1140815
Cap-screw DIN 912 - M8×16	2	9 g 0.63.D00912.08016

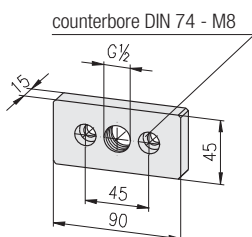
**45×90**

Description	Weight	Article-No.
Pneumatic end plate set 45×90	179 g	1.51.14590
<b>Single parts</b>		
Pneumatic end plate 45×90	1	119 g 1.51.14591
Pneumatic seal 45×90	1	6 g 1.51.14592
Threaded insert M14/M8	2	18 g 1.35.1140815
Cap-screw DIN 912 - M8×16	2	9 g 0.63.D00912.08016

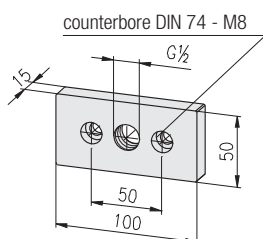
**50×100**

Description	Weight	Article-No.
Pneumatic end plate set 50×100	206 g	1.51.15100
<b>Single parts</b>		
Pneumatic end plate 50×100	1	145 g 1.51.15101
Pneumatic seal 50×100	1	7 g 1.51.15102
Threaded insert M14/M8	2	18 g 1.35.1140815
Cap-screw DIN 912 - M8×16	2	9 g 0.63.D00912.08016

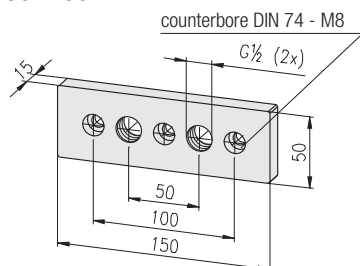
**50×150**

Description	Weight	Article-No.
Pneumatic end plate set 50×150	322 g	1.51.15150
<b>Single parts</b>		
Pneumatic end plate 50×150	1	231 g 1.51.15151
Pneumatic seal 50×150	1	10 g 1.51.15152
Threaded insert M14/M8	3	18 g 1.35.1140815
Cap-screw DIN 912 - M8×16	3	9 g 0.63.D00912.08016

**Pneumatic end plate sets**  
 with thread

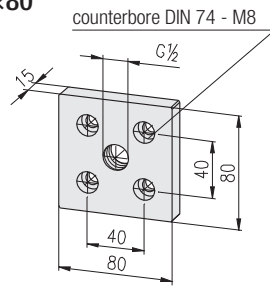
**80×80**

Description	Weight	Article-No.
Pneumatic end plate set 80×80	251 g	1.51.18080
<b>Single parts</b>		
	<b>Pcs.</b>	
Pneumatic end plate 80×80	1 136 g	1.51.18081
Pneumatic seal 80×80	1 7 g	1.51.18082
Threaded insert M14/M8	4 18 g	1.35.1140815
Cap-screw DIN 912 - M8×16	4 9 g	0.63.D00912.08016

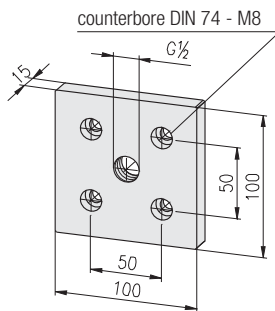
**100×100**

Description	Weight	Article-No.
Pneumatic end plate set 100×100	416 g	1.51.20100
<b>Single parts</b>		
	<b>Pcs.</b>	
Pneumatic end plate 100×100	1 296 g	1.51.20101
Pneumatic seal 100×100	1 12 g	1.51.20102
Threaded insert M14/M8	4 18 g	1.35.1140815
Cap-screw DIN 912 - M8×16	4 9 g	0.63.D00912.08016

## Pneumatic connection plates

**Application**

Pneumatic connection for inlet and exhaust of air pressure

**Technical data**

End plate

- material: aluminium
  - strength: F22
  - surface: black powder-coated
- O-Ring
- material: NBR

**Comments**

Counterbore DIN 74 - M6 / M8 for cap-screw DIN 912 - M6 / M8

**30×60**

counterbore DIN 74 - M6

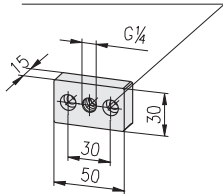

Description	Weight	Article-No.
Pneumatic connection plate set 30×60	59.2 g	1.52.03061
<b>Single parts</b>		
Pneumatic connection plate for 30×60	1 40.0 g	1.52.03062
O-Ring 14×3	1 0.6 g	1.59.11403
T-Nut for subs. insertion F, M6	2 4.3 g	1.32.4FM6
Cap-screw DIN 912 - M6×12	2 5.0 g	0.63.D00912.06012

**40×80**

counterbore DIN 74 - M6

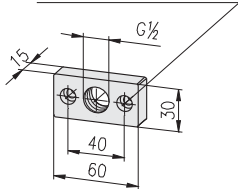

Description	Weight	Article-No.
Pneumatic connection plate set 40×80	80.6 g	1.52.14081
<b>Single parts</b>		
Pneumatic connection plate for 40×80	1 50.0 g	1.52.14082
O-Ring 20×3	1 0.6 g	1.59.12003
T-Nut for subs. insertion E, M6	2 10.0 g	1.32.4EM6
Cap-screw DIN 912 - M6×16	2 5.0 g	0.63.D00912.06016

**45×90**

counterbore DIN 74 - M6

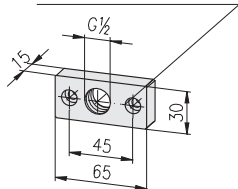

Description	Weight	Article-No.
Pneumatic connection plate set 45×90	84.6 g	1.52.04591
<b>Single parts</b>		
Pneumatic connection plate for 45×90	1 5.0 g	1.52.04592
O-Ring 20×3	1 0.6 g	1.59.12003
T-Nut for subs. insertion E, M6	2 10.0 g	1.32.4EM6
Cap-screw DIN 912 - M6×16	2 5.0 g	0.63.D00912.06016

**50×100**

counterbore DIN 74 - M6

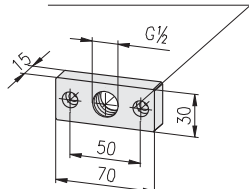

Description	Weight	Article-No.
Pneumatic connection plate set 50×100	90.6 g	1.52.15101
<b>Single parts</b>		
Pneumatic connection plate for 50×100	1 60.0 g	1.52.15102
O-Ring 20×3	1 0.6 g	1.59.12003
T-Nut for subs. insertion E, M6	2 10.0 g	1.32.4EM6
Cap-screw DIN 912 - M6×16	2 5.0 g	0.63.D00912.06016

## Pneumatic extension sets

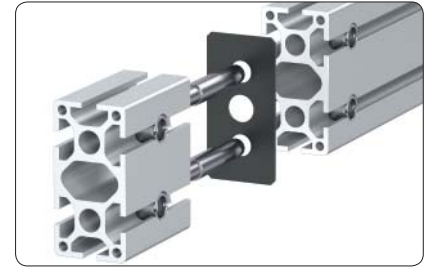
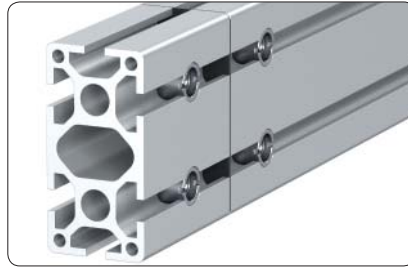

For the extension of air pressurised profiles

**for profile 30×60**

Description	Pcs.	Weight	Article-No.
Pneumatic extension set 30×60		177 g	1.54.03061
<b>Single parts</b>			
Pneumatic seal 30×60	1	3 g	1.51.13062
Connector, profile extension	2	87 g	1.21.3V0

**for profile 40×80**

Pneumatic extension set 40×80		193 g	1.54.04081
<b>Single parts</b>			
Pneumatic seal 40×80	1	5 g	1.51.14082
Connector, profile extension	2	94 g	1.21.4V0

**for profile 45×90**

Pneumatic extension set 45×90		204 g	1.54.04591
<b>Single parts</b>			
Pneumatic seal 45×90	1	6 g	1.51.14592
Connector, profile extension	2	99 g	1.21.45V0

**for profile 50×100**

Pneumatic extension set 50×100		211 g	1.54.05101
<b>Single parts</b>			
Pneumatic seal 50×100	1	7 g	1.51.15102
Connector, profile extension	2	102 g	1.21.5V0

**for profile 50×150**

Pneumatic extension set 50×150		316 g	1.54.05151
<b>Single parts</b>			
Pneumatic seal 50×150	1	10 g	1.51.15152
Connector, profile extension	3	102 g	1.21.5V0

**for profile 60×90**

Pneumatic extension set 60×90		239 g	1.54.06091
<b>Single parts</b>			
Pneumatic seal 60×90	1	7 g	1.51.16092
Connector, profile extension	2	116 g	1.21.6V0

**for profile 80×80 angle**

Pneumatic extension set 80×80 W		289 g	1.54.08081W
<b>Single parts</b>			
Pneumatic seal 80×80 W	1	7 g	1.51.18082W
Connector, profile extension	3	94g	1.21.4V0

**for profile 80×80**

Pneumatic extension set 80×80		384 g	1.54.08081
<b>Single parts</b>			
Pneumatic seal 80×80	1	8 g	1.51.18082
Connector, profile extension	4	94 g	1.21.4V0

**for profile 100×100**

Pneumatic extension set 100×100		420 g	1.54.10101
<b>Single parts</b>			
Pneumatic seal 100×100	1	12 g	1.51.20102
Connector, profile extension	4	102 g	1.21.5V0

## Pneumatic 90° connection sets



For 90° connections of air pressurised profiles

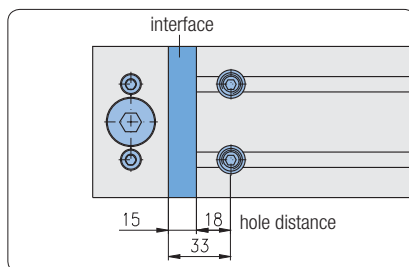

For the connection of profile 80×80, 100×100 a pneumatic connecting plate must be inserted to seal the chamber inside

**for profile 30×60**

Description	Pcs.	Weight	Article-No.
Pneumatic 90° connection set 30×60		99 g	1.55.03061
<b>Single parts</b>			
Pneumatic seal 30×60	1	3 g	1.51.13062
Connector, standard 90°	2	48 g	1.21.3F2

**for profile 40×80**

Pneumatic 90° connection set 40×80		115 g	1.55.04081
<b>Single parts</b>			
Pneumatic seal 40×80	1	5 g	1.51.14082
Connector, standard 90°	2	55 g	1.21.4E2

**for profile 45×90**

Pneumatic 90° connection set 45×90		63 g	1.55.04591
<b>Single parts</b>			
Pneumatic seal 45×90	1	6 g	1.51.14592
Connector, standard 90°	2	57 g	1.21.45E2

**for profile 50×100**

Pneumatic 90° connection set 50×100		125 g	1.55.05101
<b>Single parts</b>			
Pneumatic seal 50×100	1	7 g	1.51.15102
Connector, standard 90°	2	59 g	1.21.5E2

**for profile 50×150**

Pneumatic 90° connection set 50×150		187 g	1.55.05151
<b>Single parts</b>			
Pneumatic seal 50×150	1	10 g	1.51.15152
Connector, standard 90°	3	59 g	1.21.5E2

**for profile 60×90**

Pneumatic 90° connection set 60×90		70 g	1.55.06091
<b>Single parts</b>			
Pneumatic seal 60×90	1	7 g	1.51.16092
Connector, standard 90°	2	63 g	1.21.6E2

**for profile 80×80**

Pneumatic 90° connection set 80×80		446 g	1.55.08081
<b>Single parts</b>			
Pneumatic seal 80×80	1	8 g	1.51.18082
Connector, standard 90°	4	55 g	1.21.4E2
Pneumatic connecting plate	1	217 g	1.55.08084
O-Ring 20×3	1	0.6 g	1.59.12003



for profile 100×100

Description	Pcs.	Weight	Article-No.
Pneumatic 90° connection set 100×100		618 g	1.55.10101
<b>Single parts</b>			
Pneumatic seal 100×100	1	12 g	1.51.20102
Connector, standard 90°	4	55 g	1.21.5E2
Pneumatic connecting plate	1	369 g	1.55.10104
O-Ring 20×3	1	0.6 g	1.59.12003

## Pneumatic accessories



### Application

Blanking plug for the connection thread



### Application

Reducing nipple to reduce the connection thread

## Blanking plug

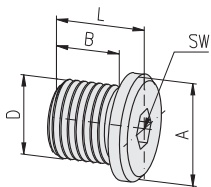

### Technical data

material:

- blanking plug: steel, galvanised
- sealing: NBR

### Comments

Including sealing

Description	D	A	B	L	SW	Weight	Article-No.
Blanking plug,	B-1/4"	18	12	15	6	15 g	1.59.01030
Blanking plug,	B-1/2"	26	14	18	10	43 g	1.59.01050

## Reducing nipple

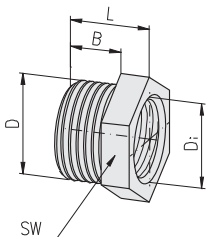

### Technical data

material: brass

Description	Di	D	B	L	SW	Weight	Article-No.
Reducing nipple,	1/4" i - 3/8" a		9	14	19	14 g	1.59.02040
Reducing nipple,	3/8" i - 1/2" a		10	14	22	25 g	1.59.02050

## Sealing ring

for reducing nipple

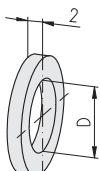

### Technical data

material: PA, white

Description	D	Weight	Article-No.
Sealing ring	Ø1/4"	1 g	1.59.03030
Sealing ring	Ø3/8"	1 g	1.59.03040
Sealing ring	Ø1/2"	2 g	1.59.03050

**Handles light PA**



**Application**

For doors and drawers of light material

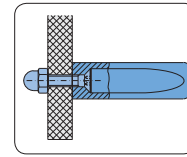

Mounting on panel elements

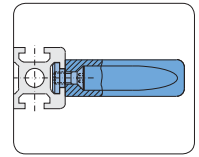

Mounting on profiles

**Technical data**

material: PA

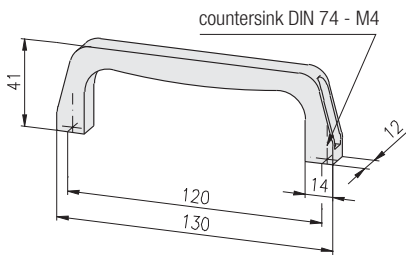

Description	Colour	Weight	Article-No.
Handle light PA	grey	30 g	1.61.20.1
Handle light PA	black	30 g	1.61.20.2

**Handle light Alu**



**Application**

For doors and drawers of light material

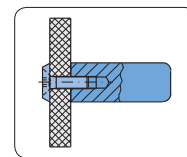

Mounting on panel elements

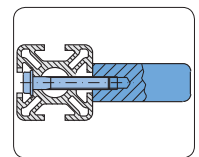

Mounting on profiles

**Technical data**

material: aluminium  
surface: natural anodised

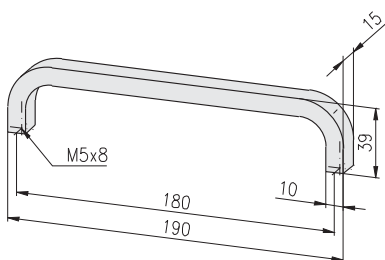

Description	Weight	Article-No.
Handle light Alu	85 g	1.61.210

Handle PA



Application

Ergonomical designed handle

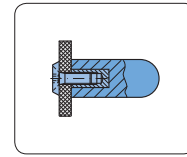

Mounting on panel elements

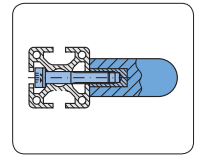

Mounting on profiles

Technical data

material: PA  
colour: black

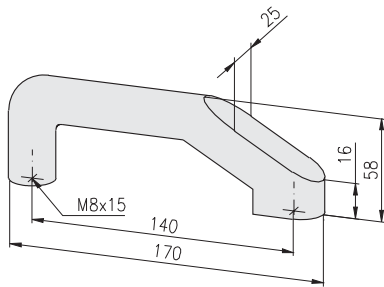

Description

Handle PA, with thread M8

Weight

166 g

Article-No.

1.61.230

Handles PA



Application

Handle with fixing possibilities from the front and the rear

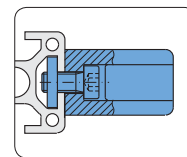

Handle with bore

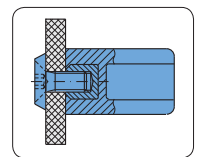

Handle with thread

Technical data

material: PA  
colour: black

with bore

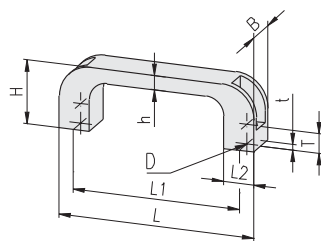

Description

Description	D	L	Weight	Article-No.
Handle PA, with bore	Ø6.5	110	24 g	1.61.24110
Handle PA, with bore	Ø6.5	139	44 g	1.61.24139
Handle PA, with bore	Ø8.5	151	64 g	1.61.24151
Handle PA, with bore	Ø8.5	200	74 g	1.61.24200
Handle PA, with bore	Ø10.5	260	114 g	1.61.24260

with thread

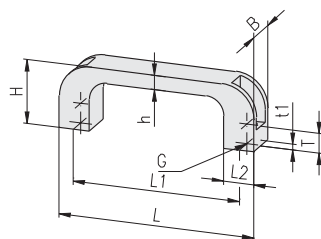

Description

Description	G	L	Weight	Article-No.
Handle PA, with thread	M6	110	30 g	1.61.25110
Handle PA, with thread	M6	139	50 g	1.61.25139
Handle PA, with thread	M8	151	70 g	1.61.25151
Handle PA, with thread	M8	200	88 g	1.61.25200
Handle PA, with thread	M10	260	125 g	1.61.25260

L	L1	L2	H	h	T	t	t1	B
110	94	17	37	8	13	6	10	21
139	120	20	40	10	15	6	10	24
151	132	22	43	10	16	6	15	26
200	180	25	50	11	20	9	15	28
260	235	28	53	12	21	11	15	32

**Handles PA**



**Application**

Machine handle with ergonomic design and finger protection; to mount on doors, flaps and aluminum profiles

**Technical data**

material: PA  
colour: black

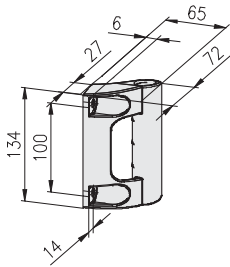

**Description**

Handle PA, 135, with screw covers

**Weight**

117 g

**Article-No.**

1.61.26135



**Technical data**

material: PA  
colour: black

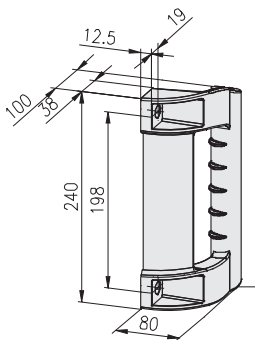

**Description**

Handle PA, 240, with screw covers

**Weight**

356 g

**Article-No.**

1.61.26240



**Handle system  
oval design**



**Application**

Handle system for making handles of any length

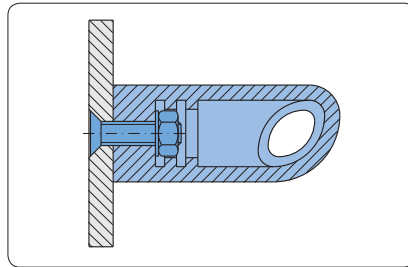

Mounting on panel elements

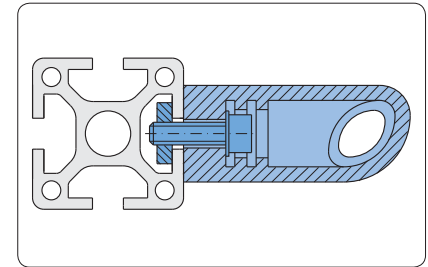

Mounting on profiles

**Oval corner piece right**

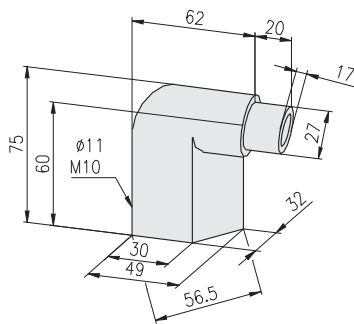

**Technical data**

material: PA-GF  
colour: black

**Description**

Oval corner piece right

**Weight**

65 g

**Article-No.**

1.61.290

**Oval corner piece left**

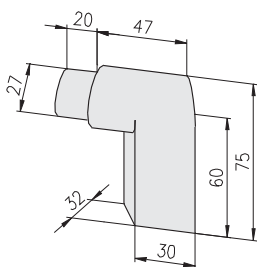

**Technical data**

material: PA-GF  
colour: black

**Description**

Oval corner piece left

**Weight**

65 g

**Article-No.**

1.61.291

**Oval tube 35x4**

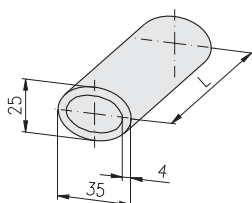

**Technical data**

material: aluminium  
surface: natural anodised  
tube length: 3 m

**Description**

Oval tube 35x4

bar

**Weight**

2.5 kg

**Article-No.**

1.19.14535.30



Oval tube 35x4

cut to length

0.83 kg/m

1.19.14535-A00A00/...

/... = length in mm

**Grab handles**



**Application**

Alu grip handles for customer's assembly from standard profiles

**Comments**

Grab handles increase the rigidity of panels without profile frames

**Profile 20x30, 1F, LP**

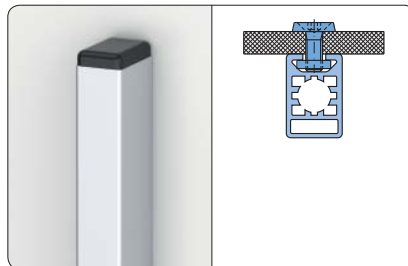
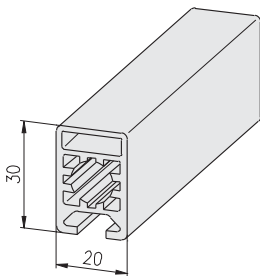

Fixing of the profile directly on the panel element

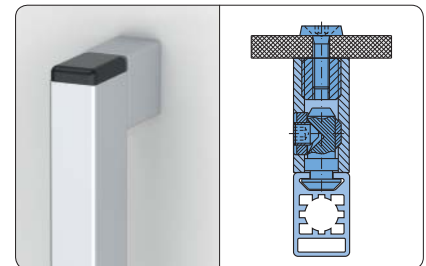

Fixing of the profile with a connecting piece on the panel element

**Description**

 Profile 20x30, 1F, LP	cut to length	0.66 kg/m	1.11.020030.14LP-A00A00/... /... = length in mm
---	---------------	-----------	--

**Weight**

**Article-No.**

**Grab handle profiles**

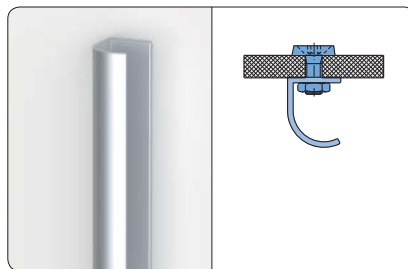
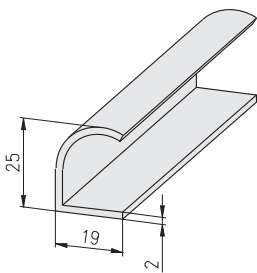

**Description**

 Grab handle profile	cut to length	0.3 kg/m	1.19.14319-A00A00/... /... = length in mm
---	---------------	----------	--

**Weight**

**Article-No.**

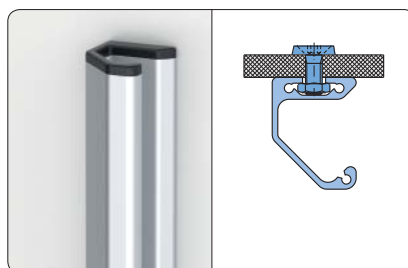
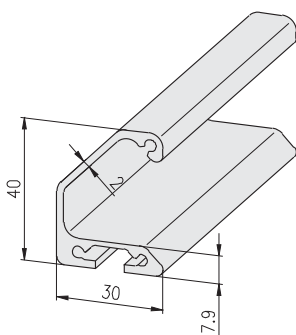

**Description**

 Grab handle profile	cut to length	0.73 kg/m	1.19.14330-A00A00/... /... = length in mm
---	---------------	-----------	--

**Weight**

**Article-No.**

**Technical data**

material: PA-GF  
colour: black

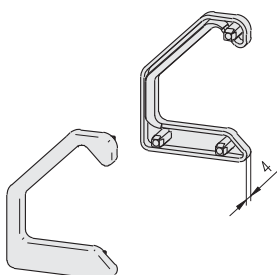

**Description**

Cover cap kit left/right for grab handle profile		3.6 g	1.19.14330A
--	--	-------	-------------

**Weight**

**Article-No.**

Hinges



Application

Hinge for doors and flaps of light material

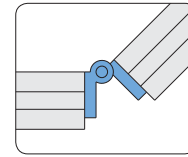

Face-sided connection of 2 profiles

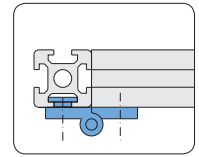

Connection of 2 profiles in rectangular position

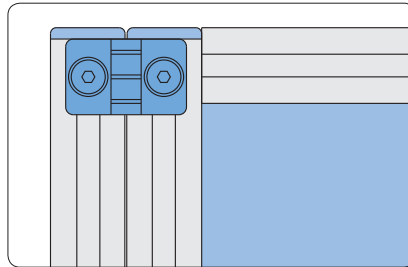

Doors with profile frames

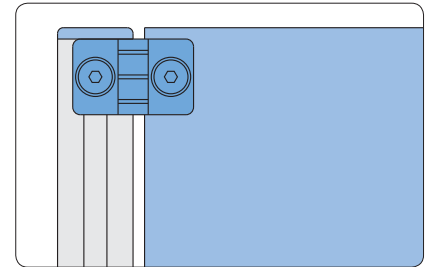

Doors made of panel elements without profile frames

Technical data			
Hinge	20×32	30×39	40×40
material:	PA-GF	PA-GF	GD-Zn, coated
colour:	black		
max. static load:	50 N	100 N	150 N

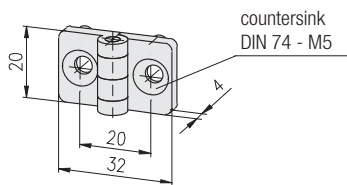

- 16
- 20
- 30
- 40
- 45
- 50
- 60

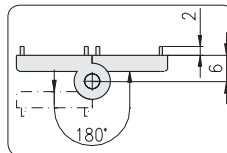

Swivel angle

Comments

Countersink DIN 74 - M5 for countersunk screw DIN 7991 - M5

Description

Hinge 20×32

Weight

6 g

Article-No.

1.62.12032

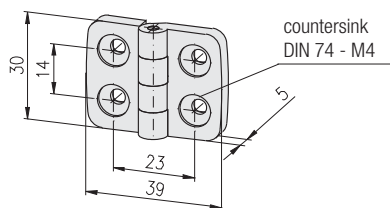

- 16
- 20
- 30
- 40
- 45
- 50
- 60

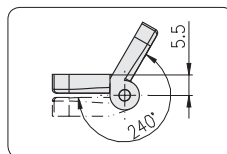

Swivel angle

Comments

Countersink DIN 74 - M4 for countersunk screw DIN 7991 - M4

Description

Hinge 30×39

Weight

7.6 g

Article-No.

1.62.23039

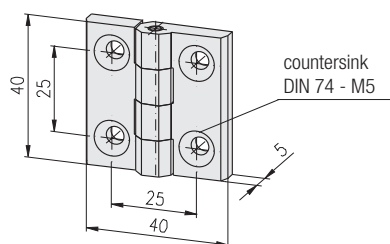

- 16
- 20
- 30
- 40
- 45
- 50
- 60

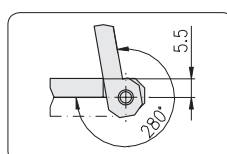

Swivel angle

Comments

Countersink DIN 74 - M5 for countersunk screw DIN 7991 - M5

Description

Hinge 40×40

Weight

55 g

Article-No.

1.62.24040



Lift-off hinges



**Application**

Enables the connection of different profile widths in parallel as well as in rectangular arrangement

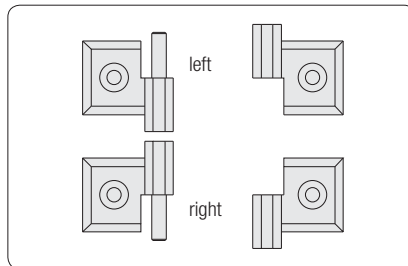

Non-liftable door with one right- and one left-sided hinge

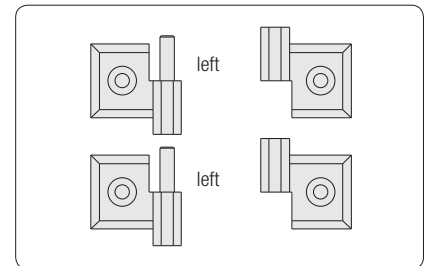

Liftable door with two similar hinges

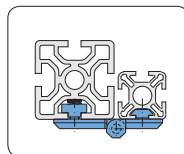

1 profile 30×30  
1 profile 50×50

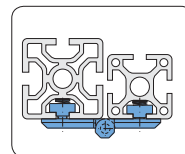

1 profile 40×40  
1 profile 50×50

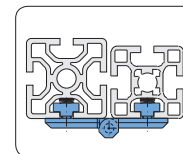

1 profile 45×45  
1 profile 50×50

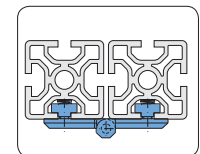

2 profiles 50×50

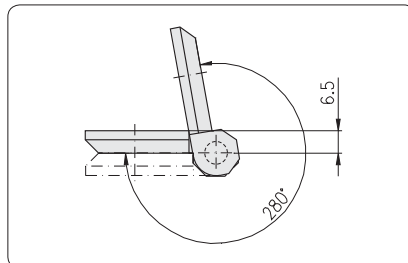

Swivel angle

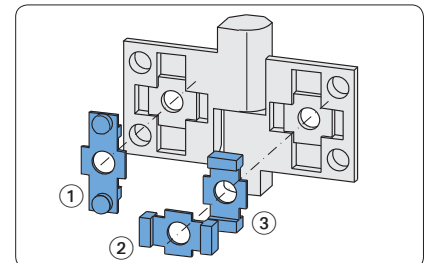

Application of locking device:

- ① for panel element
- ② for profile slot, horizontal
- ③ for profile slot, vertical

**Technical data**

material: GD-Zn  
 surface: black coated  
 hinge bolt: stainless steel  
 max. static load: 250 N

**Comments**

Countersink DIN 74 - M6 for  
 countersunk screw DIN 7991 - M6

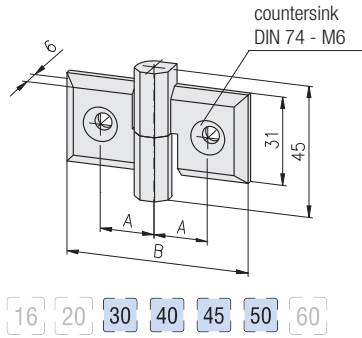

Description A	B	Weight	Article-No.
Hinge 31, A16.5 left	59	68 g	1.62.331.16/16L
Hinge 31, A19.0 left	64	72 g	1.62.331.19/19L
Hinge 31, A21.5 left	69	76 g	1.62.331.21/21L
Hinge 31, A24.0 left	74	81 g	1.62.331.24/24L
Hinge 31, A26.5 left	79	86 g	1.62.331.26/26L

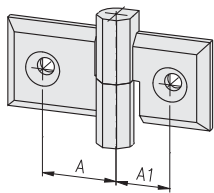

**Combinations**

Description A <sup>1)</sup> A1 <sup>1)</sup>	Article-No.
Hinge 31 × □□/□□ left	1.62.331.□□/□□L

<sup>1)</sup> Data without decimal places

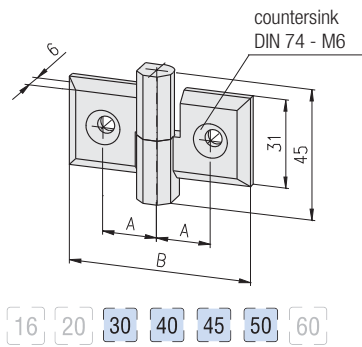

Description A	B	Weight	Article-No.
Hinge 31, A16.5 right	59	68 g	1.62.331.16/16R
Hinge 31, A19.0 right	64	72 g	1.62.331.19/19R
Hinge 31, A21.5 right	69	76 g	1.62.331.21/21R
Hinge 31, A24.0 right	74	81 g	1.62.331.24/24R
Hinge 31, A26.5 right	79	86 g	1.62.331.26/26R

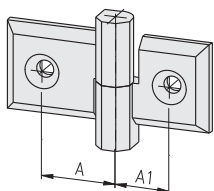

**Combinations**

Description A <sup>1)</sup> A1 <sup>1)</sup>	Article-No.
Hinge 31 × □□/□□ right	1.62.331.□□/□□R

<sup>1)</sup> Data without decimal places

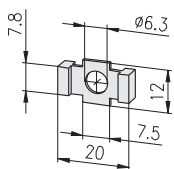

**Technical data**

material: GD-Zn  
surface: bare

Description	Weight	Article-No.
Anti-twist device for slot 8 mm	4 g	1.62.331x1

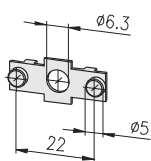

**Technical data**

material: GD-Zn  
surface: bare

Description	Weight	Article-No.
Anti-twist device for panel element	4 g	1.62.331x2

Lift-off hinges



**Application**

The hinges enable the connection of profiles with different widths

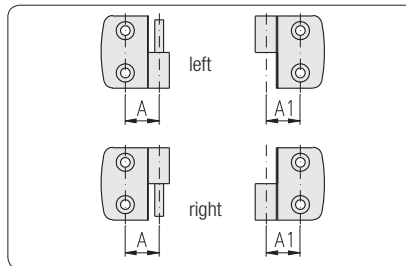

Non-liftable door with one right- and one left-sided hinge

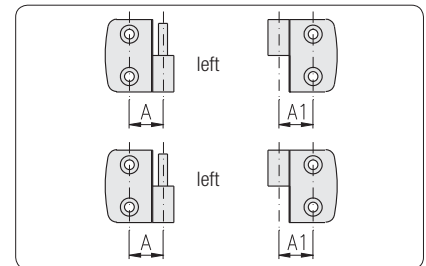

Liftable door with two similar hinges

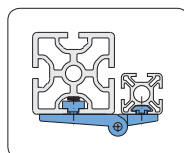

1 profile 60×60  
1 profile 30×30

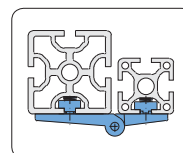

1 profile 60×60  
1 profile 40×40

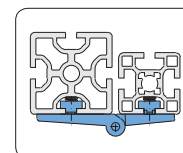

1 profile 60×60  
1 profile 45×45

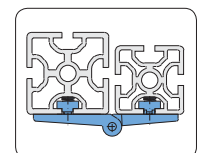

1 profile 60×60  
1 profile 50×50

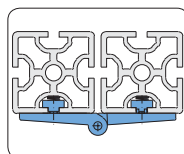

2 profiles 60×60

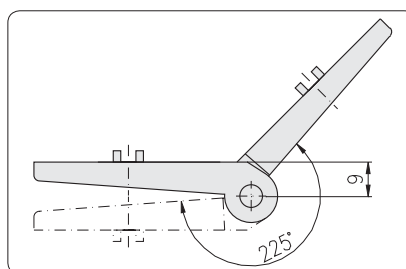

Swivel angle

**Technical data**

material: PA-GF  
 surface: black  
 hinge bolt: stainless steel  
 max. static load: 150 N

**Comments**

Countersink DIN 74 - M6 for  
 countersunk screw DIN 7991 - M6

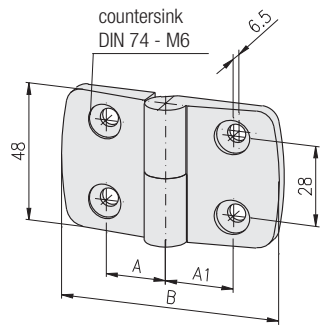

16 20 30 40 45 50 60

Description	A = A1	B	Weight	Article-No.
Lift-off hinge 48	A17.5, left	59	8 g	1.62.348.17/17L
Lift-off hinge 48	A22.5, left	77	10 g	1.62.348.22/22L
Lift-off hinge 48	A25.0, left	87	15 g	1.62.348.25/25L
Lift-off hinge 48	A27.5, left	97	25 g	1.62.348.27/27L
Lift-off hinge 48	A32.5, left	115	35 g	1.62.348.32/32L

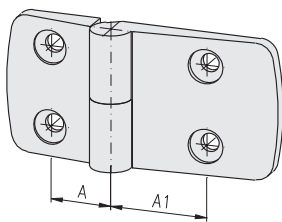

**Combinations**

Description	A <sup>1)</sup> A1 <sup>1)</sup>	Article-No.
Lift-off hinge 48 × □□/□□ left		1.62.348.□□/□□L

<sup>1)</sup> Data without decimal places

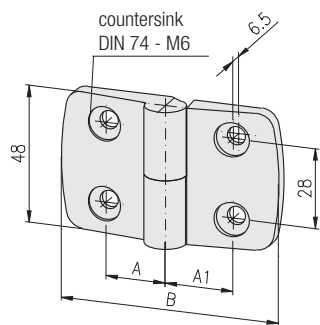

16 20 30 40 45 50 60

Description	A = A1	B	Weight	Article-No.
Lift-off hinge 48	A17.5, right	59	8 g	1.62.348.17/17R
Lift-off hinge 48	A22.5, right	77	10 g	1.62.348.22/22R
Lift-off hinge 48	A25.0, right	87	15 g	1.62.348.25/25R
Lift-off hinge 48	A27.5, right	97	25 g	1.62.348.27/27R
Lift-off hinge 48	A32.5, right	115	35 g	1.62.348.32/32R

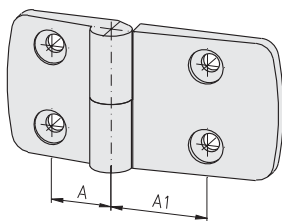

**Combinations**

Description	A <sup>1)</sup> A1 <sup>1)</sup>	Article-No.
Lift-off hinge 48 × □□/□□ right		1.62.348.□□/□□R

<sup>1)</sup> Data without decimal places

Hinges



Application

Hinge for doors and flaps of light material

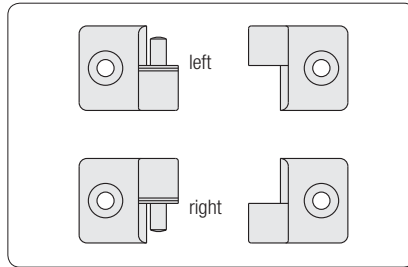

Non-liftable door with one right- and one left-sided hinge

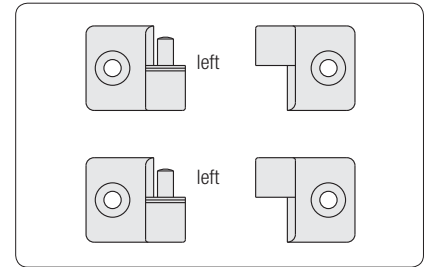

Liftable door with two similar hinges

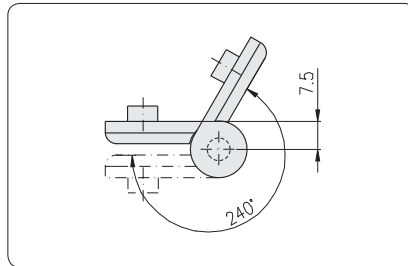

Swivel angle

Technical data

material: PA-GF  
 colour: black  
 max. static load: 100 N

Comments

Countersink DIN 74 - M6 for countersunk screw DIN 7991 - M6

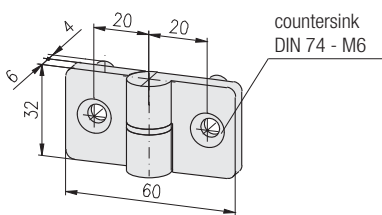

- 16
- 20
- 30
- 40
- 45
- 50
- 60

Description

Hinge 32x60 left

Weight

21 g

Article-No.

1.62.41L

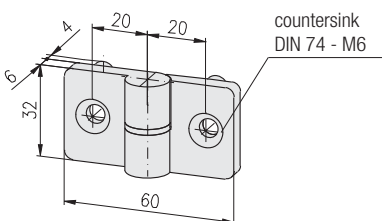

- 16
- 20
- 30
- 40
- 45
- 50
- 60

Description

Hinge 32x60 right

Weight

21 g

Article-No.

1.62.41R

Double hinge



**Application**

Hinge for doors and flaps of light material

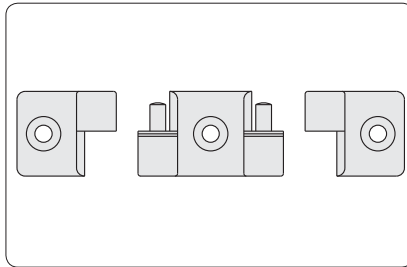

Liftable doors

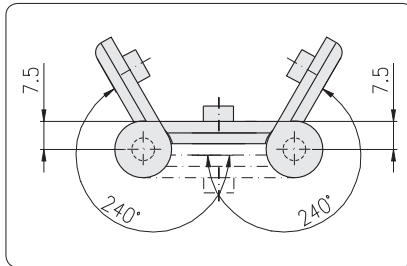

Swivel angle

**Technical data**

material: PA-GF  
max. static load: 100 N

**Comments**

Countersink DIN 74 - M6 for countersunk screw DIN 7991 - M6

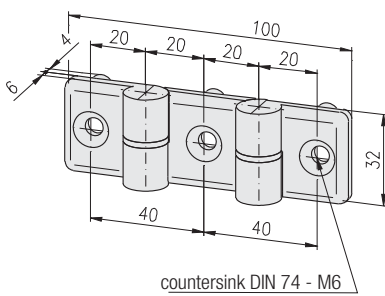

- 16
- 20
- 30
- 40
- 45
- 50
- 60

Description	Colour	Weight	Article-No.
Double hinge	grey	40 g	1.62.420.1
Double hinge	black	40 g	1.62.420.2

Hinges



Application

The hinges enable the connection of profiles with different widths

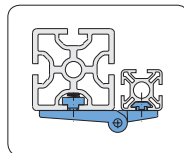

1 profile 60×60  
1 profile 30×30

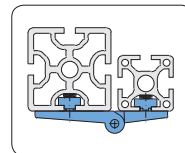

1 profile 60×60  
1 profile 40×40

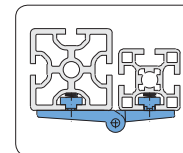

1 profile 60×60  
1 profile 45×45

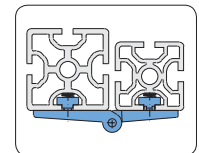

1 profile 60×60  
1 profile 50×50

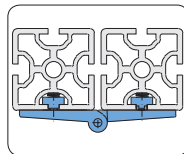

2 profiles 60×60

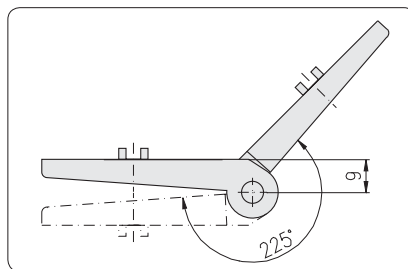

Swivel angle

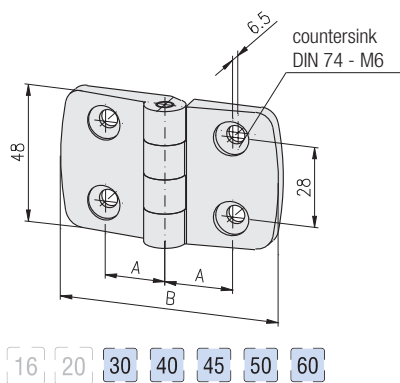

Technical data

material: PA-GF  
colour: black  
hinge bolt: stainless steel  
max. static load: 200 N

Comments

Countersink DIN 74 - M6 for  
countersunk screw DIN 7991 - M6

Description	A	B	Weight	Article-No.
Hinge 48 fixed	A17.5	59	8 g	1.62.448.17/17
Hinge 48 fixed	A22.5	77	10 g	1.62.448.22/22
Hinge 48 fixed	A25.0	87	15 g	1.62.448.25/25
Hinge 48 fixed	A27.5	97	25 g	1.62.448.27/27
Hinge 48 fixed	A32.5	115	35 g	1.62.448.32/32

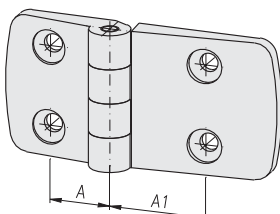

Combinations

Description	A <sup>1)</sup>	A1 <sup>1)</sup>	Article-No.
Hinge 48 fixed × □□/□□			1.62.448.□□/□□

<sup>1)</sup> Data without decimal places

**Hinge**  
30×60



**Application**

Hinge or higher loads such as doors with profile frames

**Technical data**

material: GD-Zn  
 colour: black  
 surface: coated  
 max. static load: 400 N

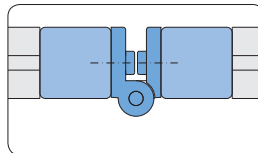

Connection of 2 vertical profiles, all anti-twist safety devices removed

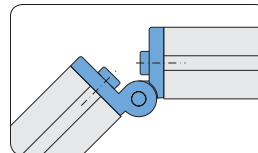

Face-sided connection of 2 profiles, with anti-twist safety device

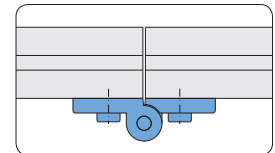

Connection of 2 horizontal profiles, with anti-twist safety device

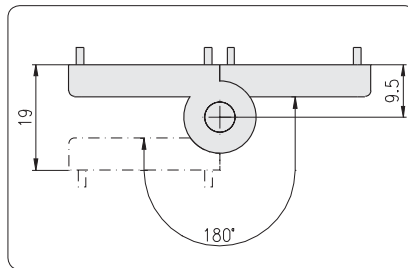
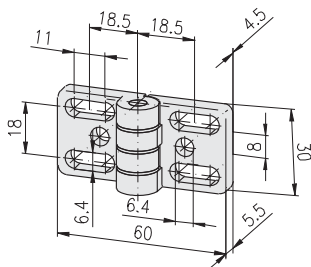

Swivel angle

- 16
- 20
- 30
- 40
- 45
- 50
- 60

**Description**

Hinge 30×60

**Weight**

68.8 g

**Article-No.**

1.62.51030060



**Hinge**  
40×80



**Application**

Hinge or higher loads such as doors with profile frames

**Technical data**

material: GD-Zn  
colour: black  
surface: coated  
max. static load: 750 N

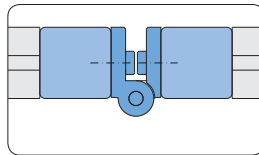

Connection of 2 vertical profiles, all anti-twist safety devices removed

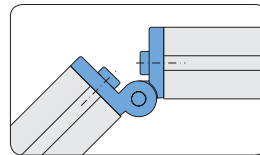

Face-sided connection of 2 vertical profiles, with anti-twist safety device

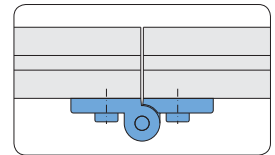

Connection of 2 horizontal profiles, with anti-twist safety device

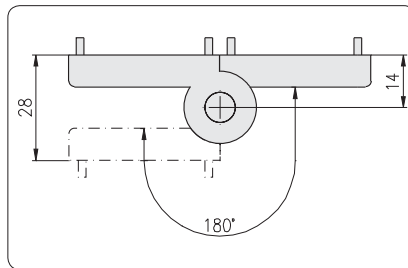
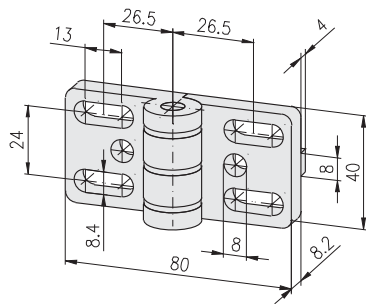

Swivel angle

- 16
- 20
- 30
- 40
- 45
- 50
- 60

**Description**

Hinge 40×80

**Weight**

180 g

**Article-No.**

1.62.520

**Hinges**  
40×80



**Application**

Hinge or higher loads such as doors with profile frames

**Technical data**

material: GD-Zn  
colour: black  
surface: powder-coated  
max. static load: 750 N

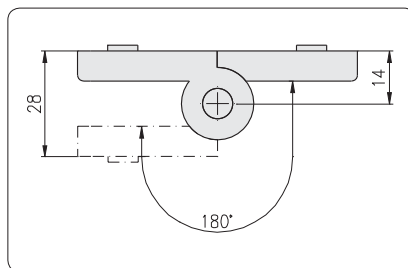

Swivel angle

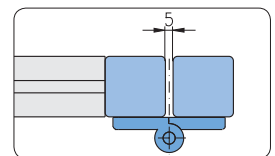

Connection of 2 vertical profiles

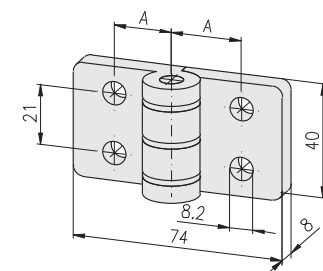

**Fastening elements:**

PG 40: T-Nut for subs. insertion E, M8 1.32.4EM8  
PG 45: T-Nut E, M8 1.32.EM8  
PG 40/45: Threaded plate E, M8 1.31.EM8

**Description**

Hinge 40×80 for PG 40  
Hinge 40×80 for PG 45

**A**

22.5  
25.0

**Weight**

194 g  
194 g

**Article-No.**

1.62.53045  
1.62.53050

- 16
- 20
- 30
- 40
- 45
- 50
- 60

Hinges



Application

Hinge with detachable fixing plug for different slot distances

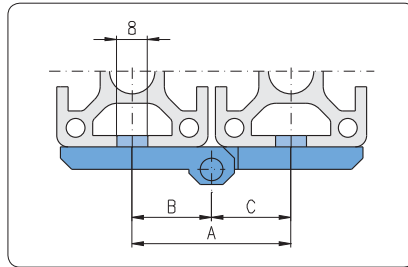

Doors with profile frames

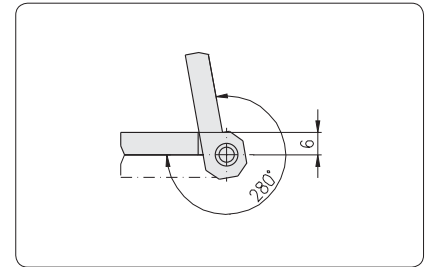

Swivel angle

Technical data

material: GD-Zn  
 surface: coated  
 colour: black  
 max. static load: 250 N

Comments

Countersink DIN 74 - M6 for  
 countersunk screw DIN 7991 - M6

Delivery unit

Including 4 plugs for F- and E-slot

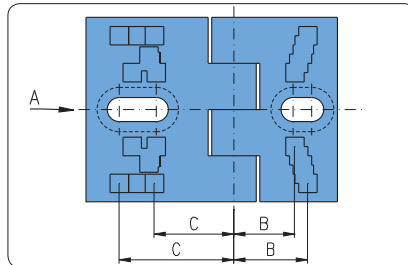

Distances for positioning plugs

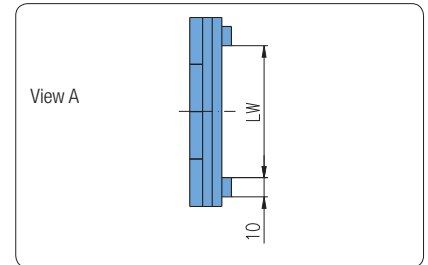

Possibilities of fastening

Legend

LW = width  
 G = threaded plate 1.31.□□□  
 T = T-Nut 1.32.4□□

		short flange					
		slots					
		F		E3		E4	
B	LW	G	T	G	T	G	T
16.5	11	-	-	x	-	x	x
17.5	14.75	x	x	x	-	x	x
18.5	20.5	x	x	x	x	x	x
19	25.25	x	x	x	x	x	x
20	30	x	x	x	x	x	x

		long flange					
		slots					
		F		E3		E4	
C	LW	G	T	G	T	G	T
21	11	-	-	x	-	x	x
21.5	30	x	x	x	x	x	x
23.5	19	x	x	x	-	x	x
26	30	x	x	x	x	x	x
27.5	11	-	-	x	-	x	x
31	30	x	x	x	x	x	x

**Hinge 50x56**

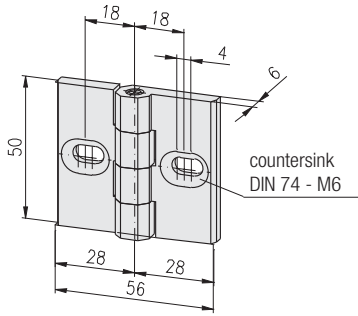

- 16 20 30 40 45 50 60

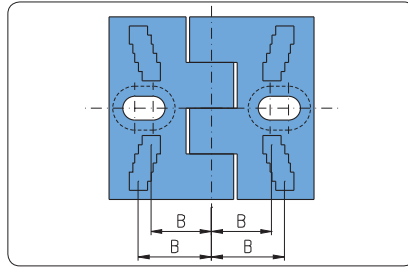

Rear view: plug assignment

**2 short flanges**

B
16.5
17.5
18.5
19
20

**Description**

Hinge 50x56

**Weight**

112 g

**Article-No.**

1.62.65056

**Hinge 50x68**

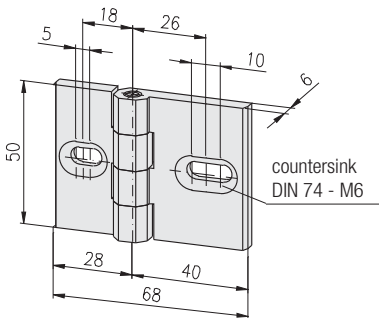

- 16 20 30 40 45 50 60

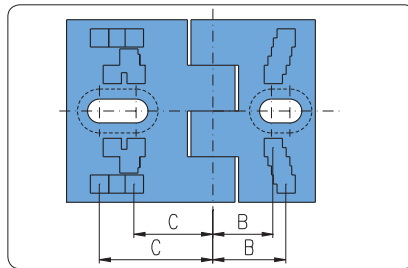

Rear view: plug assignment

**1 short flange, 1 long flange**

B	C
16.5	21
17.5	21.5
18.5	23.5
19	26
20	27.5
	31

**Description**

Hinge 50x68

**Weight**

130 g

**Article-No.**

1.62.65068

**Hinge 50x80**

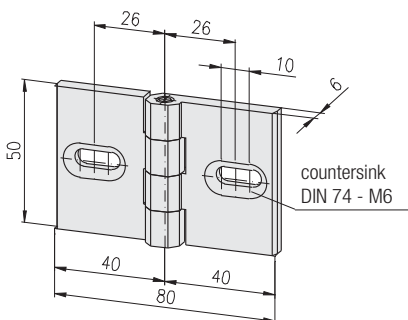

- 16 20 30 40 45 50 60

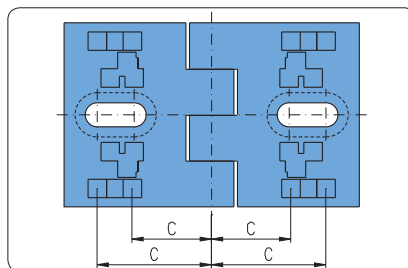

Rear view: plug assignment

**2 long flanges**

C
21
21.5
23.5
26
27.5
31

**Description**

Hinge 50x80

**Weight**

130 g

**Article-No.**

1.62.65080

Alu hinges

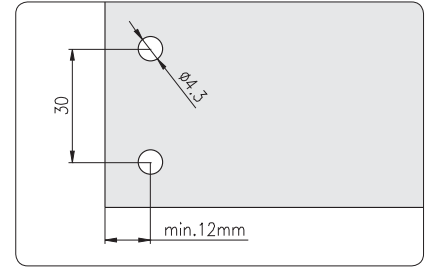

Distance of drill holes for panel elements of acrylic glass

**Application**

For doors of light material with or without profile frame, each hinge element can be combined

**Technical data**

material: aluminium Al Mg Si 0.5  
 strength: F 25  
 surface: natural anodised  
 max. static load: 100 N

**Comments**

Countersink DIN 74 - M4 for  
 countersunk screw DIN 7991 - M4  
 raw finish on request

**Type A**

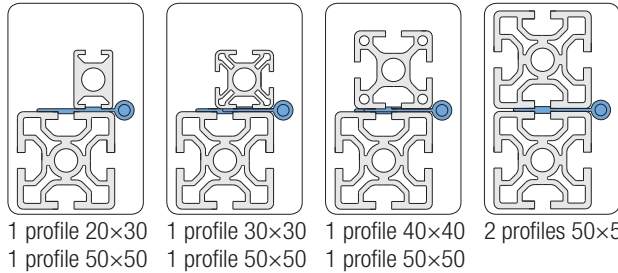

**Connection:**

- profile to profile
- leg built-in covered
- hinge elements:  
Type A  
Type A

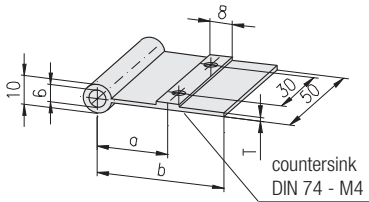

- 16 20 30 40 45 50 60

Description	T	a	b	Weight	Article-No.
Hinge element Type A, PG 20, F	1.5	15.3	21	10 g	1.62.7120
Hinge element Type A, PG 30	1.5	20.3	29	11 g	1.62.7130
Hinge element Type A, PG 30	3.0	20.3	29	15 g	1.62.7130.030
Hinge element Type A, PG 40	1.5	25.3	37	13 g	1.62.7140
Hinge element Type A, PG 40	3.0	25.3	37	19 g	1.62.7140.030
Hinge element Type A, PG 50	1.5	30.3	45	14 g	1.62.7150
Hinge element Type A, PG 50	3.0	30.3	45	21 g	1.62.7150.030

**Type B**

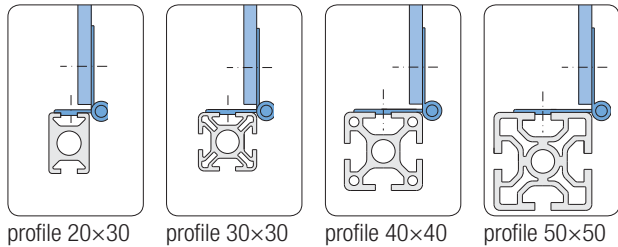

**Connection:**

- profile to panel element
- leg one side visible
- hinge elements:  
Type A  
Type B

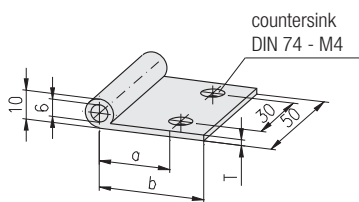

- 16 20 30 40 45 50 60

Description	T	a	b	Weight	Article-No.
Hinge element Type B, PG 20	2.0	15.3	21	11 g	1.62.7220
Hinge element Type B, PG 20	3.0	15.3	21	13 g	1.62.7220.030
Hinge element Type B, PG 30	2.0	20.3	29	11 g	1.62.7230
Hinge element Type B, PG 30	3.0	20.3	29	13 g	1.62.7230.030
Hinge element Type B, PG 40	2.0	25.3	37	13 g	1.62.7240
Hinge element Type B, PG 40	3.0	25.3	37	16 g	1.62.7240.030
Hinge element Type B, PG 50	2.0	30.3	45	14 g	1.62.7250
Hinge element Type B, PG 50	3.0	30.3	45	18 g	1.62.7250.030

**Type C**

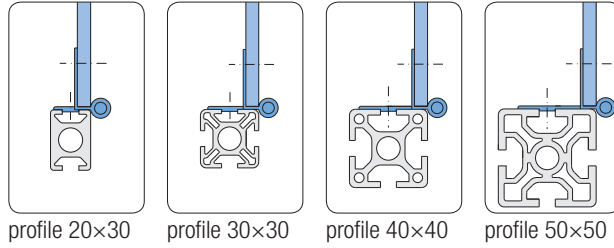

**Connection:**

- Profile to panel element
- leg built-in covered
- hinge elements:  
Type A  
Type C

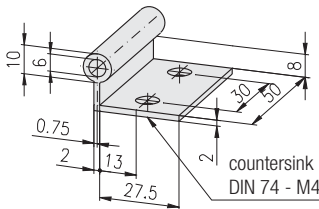

**Description**

Hinge element Type C, 30 mm

**Weight**

15 g

**Article-No.**

1.62.7330

**Press-fit pins**  
for alu hinges



Press-fit pin for one sided installation



Press-fit pin for two sided installation

**Technical data**

material: steel  
surface: galvanised

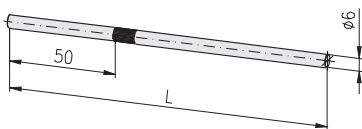

**Description**

Description	L
Press-fit pin Ø6	100
Press-fit pin Ø6	150

**Weight**

29 g  
33 g

**Article-No.**

1.62.7910  
1.62.7915

**Spacer**

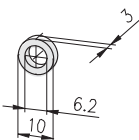

**Technical data**

material: PE  
colour: black

**Description**

Spacer

**Weight**

1 g

**Article-No.**

1.62.7810

Alu hinges, heavy



**Application**

Hinge for higher loads such as doors with profile frames

**Technical data**

hinge material: aluminium  
 strength: F25  
 surface: natural anodised

bolt material: steel  
 stainless steel

**Comments**

Countersink DIN 74 - M8 for  
 countersunk screw DIN 7991 - M8  
 raw finish on request

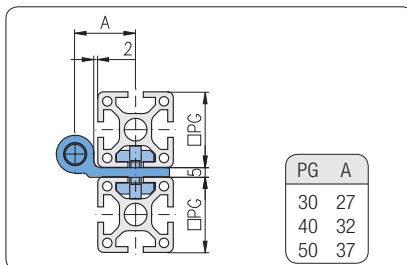

Application: Type 20

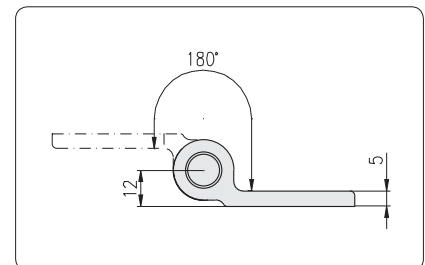

Swivel angle: Type 20

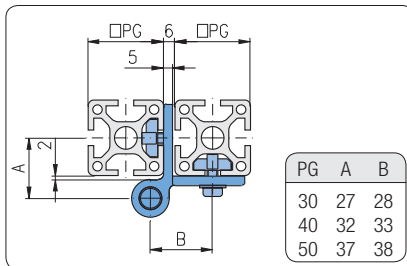

Application: Type 21, 22, 23, 31  
 with profiles PG 40/50

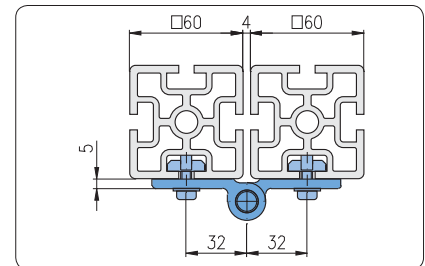

Application: Type 21, 22, 23, 31  
 with profiles PG 60

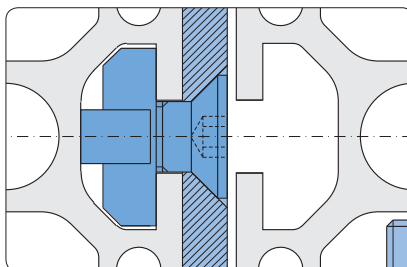

Application: Type 21, 22, 23, 31  
 with profiles PG 30/40/50

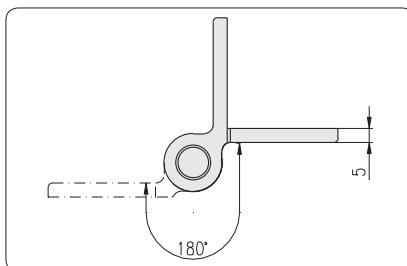

Swivel angle: Type 21, 22, 23, 31  
 at application with profiles PG 30/40/50

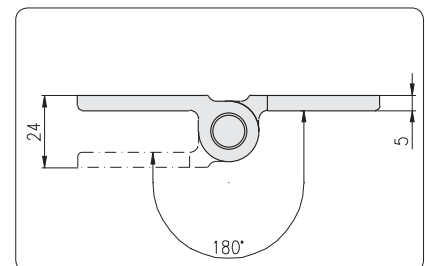

Swivel angle: Type 21, 22, 23, 31  
 at application with profiles PG 60

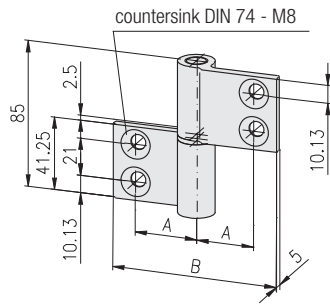

Description	Bolt	A	B	Weight	Article-No.
Alu hinge, heavy, type 20, PG 30	steel	27	78	130 g	1.62.842027085
Alu hinge, heavy, type 20, PG 40	steel	32	100	166 g	1.62.842032085
Alu hinge, heavy, type 20, PG 50	steel	37	100	166 g	1.62.842037085
Alu hinge, heavy, type 20, PG 30	stainless	27	78	130 g	1.62.842027085V
Alu hinge, heavy, type 20, PG 40	stainless	32	100	166 g	1.62.842032085V
Alu hinge, heavy, type 20, PG 50	stainless	37	100	166 g	1.62.842037085V

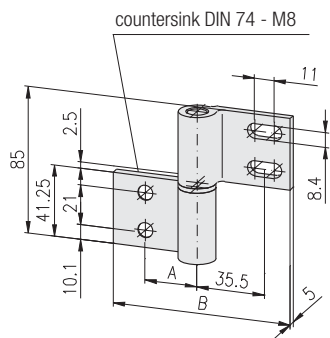

Description	Bolt	A	B	Weight	Article-No.
Alu hinge, heavy, type 21, PG 30/40-50	steel	27	89	123 g	1.62.842127085
Alu hinge, heavy, type 21, PG 40/40-50	steel	32	100	159 g	1.62.842132085
Alu hinge, heavy, type 21, PG 50	steel	37	100	159 g	1.62.842137085
Alu hinge, heavy, type 21, PG 30/40-50	stainless	27	89	123 g	1.62.842127085V
Alu hinge, heavy, type 21, PG 40/40-50	stainless	32	100	159 g	1.62.842132085V
Alu hinge, heavy, type 21, PG 50	stainless	37	100	159 g	1.62.842137085V

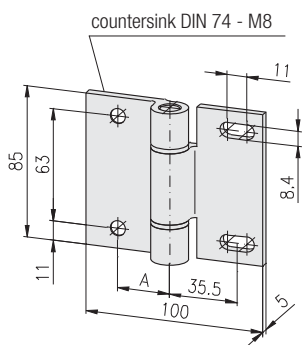

Description	Bolt	A	Weight	Article-No.
Alu hinge, heavy, type 22, PG 40/40-50	steel	32	261 g	1.62.842232085
Alu hinge, heavy, type 22, PG 50	steel	37	261 g	1.62.842237085
Alu hinge, heavy, type 22, PG 40/40-50	stainless	32	261 g	1.62.842232085V
Alu hinge, heavy, type 22, PG 50	stainless	37	261 g	1.62.842237085V

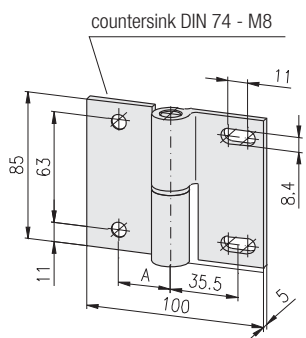

Description	Bolt	A	Weight	Article-No.
Alu hinge, heavy, type 23, PG 40/40-50	steel	32	258 g	1.62.842332085
Alu hinge, heavy, type 23, PG 50	steel	37	258 g	1.62.842337085
Alu hinge, heavy, type 23, PG 40/40-50	stainless	32	258 g	1.62.842332085V
Alu hinge, heavy, type 23, PG 50	stainless	37	258 g	1.62.842337085V

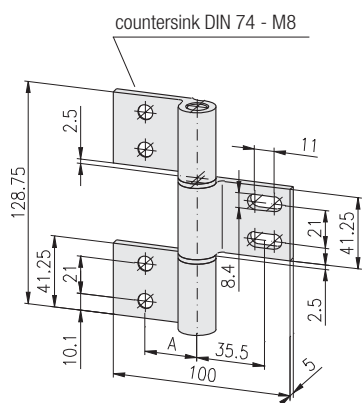

Description	Bolt	A	Weight	Article-No.
Alu hinge, heavy, type 31, PG 40/40-50	steel	32	245 g	1.62.843132128
Alu hinge, heavy, type 31, PG 50	steel	37	245 g	1.62.843137128
Alu hinge, heavy, type 31, PG 40/40-50	stainless	32	245 g	1.62.843132128V
Alu hinge, heavy, type 31, PG 50	stainless	37	245 g	1.62.843137128V

**Joints**  
with / without clamping lever



The MayTec clamping system allows backlash free adjusting and clamping



The joint can be locked with the adjustable clamping lever

**Application**

To enable infinitely variable adjusting and swivelling of profiles

**Technical data**

material: steel  
surface: galvanised

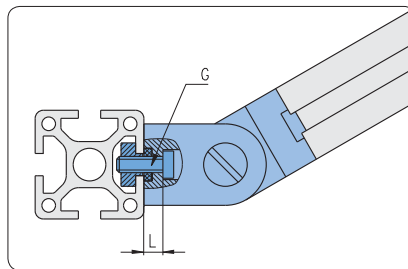

Mounting on profile side

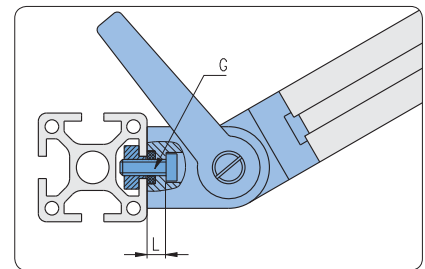

Mounting on profile side

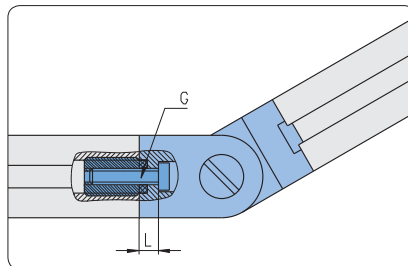

Mounting on profile end

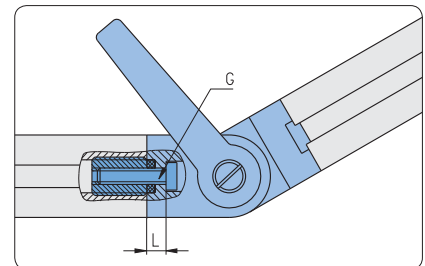

Mounting on profile end

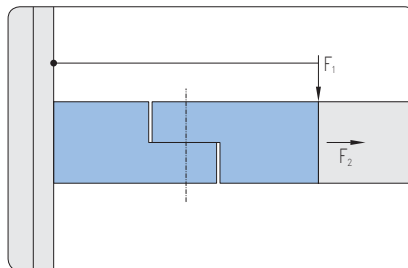

Joint	max. loads	
	F1 <sub>max</sub>	F2 <sub>max</sub>
20×20	10 Nm	2,000 N
30×30	30 Nm	4,000 N
30×50	50 Nm	4,000 N
30×100	100 Nm	8,000 N
30×100 <sup>1)</sup>	200 Nm	8,000 N
40×40	50 Nm	6,000 N
50×50	60 Nm	10,000 N

<sup>1)</sup> with fastening plate

**Comments**

- Mounting with:
- cap-screw DIN 6912
  - washer DIN 433

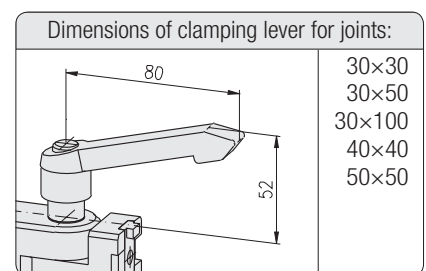
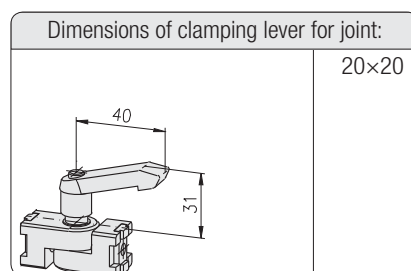

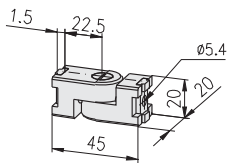

**20×20**

Description	G	L	Weight	Article-No.
Joint 20×20	M5	6.5	97 g	1.63.02021
Joint 20×20 with clamping lever	M5	6.5	114 g	1.63.12021
Anti-twist device for joint, H, L20			8 g	1.63.02022
Anti-twist device for joint, F, L20			8 g	1.63.02023

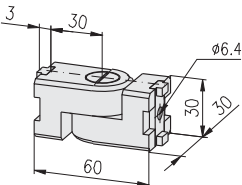
**30×30**

Description	G	L	Weight	Article-No.
Joint 30×30	M6	7.5	315 g	1.63.03031
Joint 30×30 with clamping lever	M6	7.5	380 g	1.63.13031
Anti-twist device for joint, L30			28 g	1.63.03032

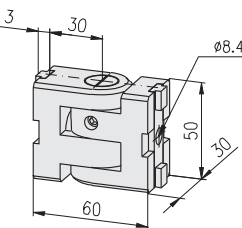
**30×50**

Description	G	L	Weight	Article-No.
Joint 30×50	M8	7.5	533 g	1.63.03051
Joint 30×50 with clamping lever	M8	7.5	600 g	1.63.13051
Anti-twist device for joint, L30			28 g	1.63.03032
Anti-twist device for joint, L50			33 g	1.63.03052

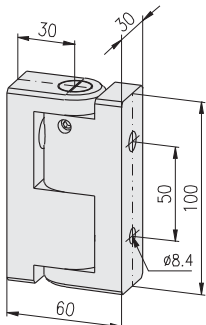
**30×100**

**Comments**

To increase the load capacity on hinge 30×100  
 ➔ fastening plate 30×150, 1.47.60315

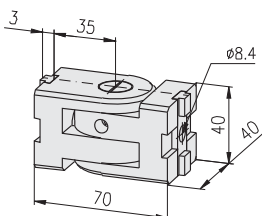
Description	G	L	Weight	Article-No.
Joint 30×100	M8	7.5	1,098 g	1.63.03101
Joint 30×100 with clamping lever	M8	7.5	1,160 g	1.63.13101

**40×40**

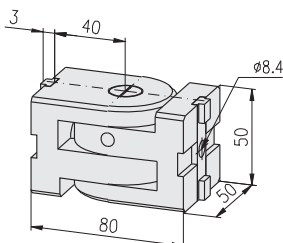
Description	G	L	Weight	Article-No.
Joint 40×40	M8	7.5	674 g	1.63.04041
Joint 40×40 with clamping lever	M8	7.5	739 g	1.63.14041
Anti-twist device for joint, L40			28 g	1.63.04042

**50×50**

Description	G	L	Weight	Article-No.
Joint 50×50	M8	7.5	1,244 g	1.63.05051
Joint 50×50 with clamping lever	M8	7.5	1,300 g	1.63.15051
Anti-twist device for joint, L50			33 g	1.63.03052

**Joints Zn  
with / without clamping lever**



The MayTec clamping system allows backlash free adjusting and clamping



The joint can be locked with the adjustable clamping lever

**Application**

To enable infinitely variable adjusting and swivelling of profiles

**Technical data**

material: GD-Zn  
surface: aluminium coloured powder-coated

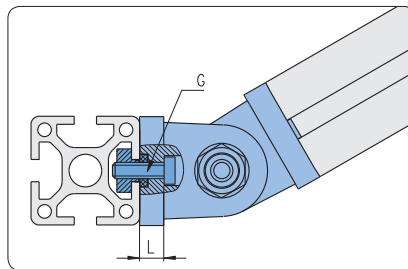

Mounting on profile side

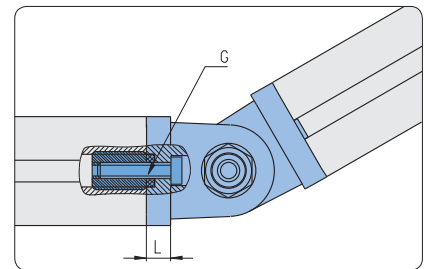

Mounting on profile end

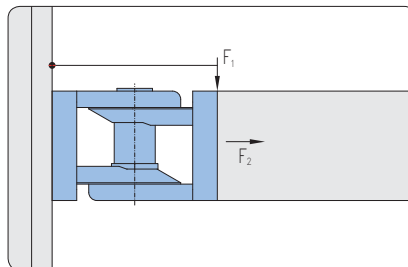

max. loads		
Joint	F1 <sub>max</sub>	F2 <sub>max</sub>
30×30	11.1 Nm	500 N
40×40	12.5 Nm	750 N
45×45	12.5 Nm	750 N

**Comments**

- Mounting with:
- cap screw DIN 6912
  - washer DIN 433

**30×30**

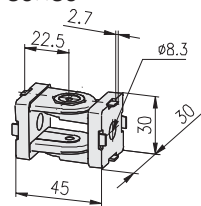

**40×40**

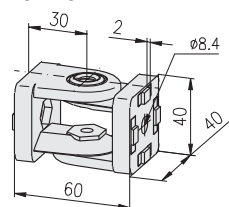

**45×45**

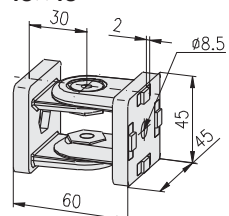

**Description**

Description	G	L	Weight	Article-No.
Joint Zn 30×30	M8	7.0	124 g	1.63.51030030
Joint Zn 30×30 with clamping lever	M8	7.0	147 g	1.63.52030030

**Description**

Description	G	L	Weight	Article-No.
Joint Zn 40×40	M8	9.0	300 g	1.63.51040040
Joint Zn 40×40 with clamping lever	M8	9.0	344 g	1.63.52040040

**Description**

Description	G	L	Weight	Article-No.
Joint Zn 45×45	M8	8.0	320 g	1.63.51045045
Joint Zn 45×45 with clamping lever	M8	8.0	366 g	1.63.52045045

**Mounting blocks  
screw-type**

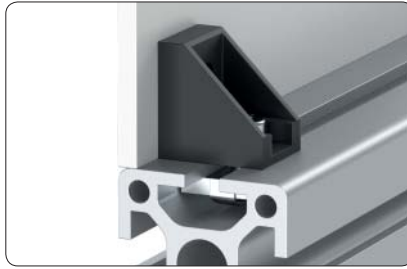

**Application**

For mounting of panels

**Technical data**

Mounting block  
material: PA-GF  
colours: grey, black  
Threaded plate  
material: steel  
surface: galvanised

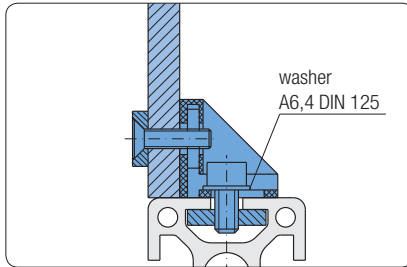

Mounting on the profile with threaded plate or T-Nut

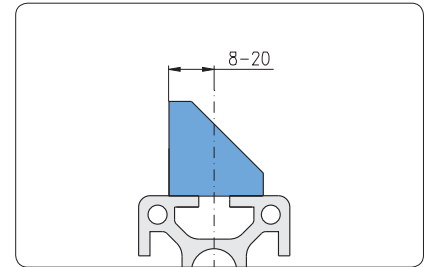

Adjustable position

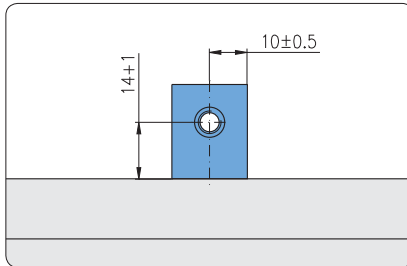

**Comments**

A 'floating' nut allows additional tolerance in the panel mounting holes.

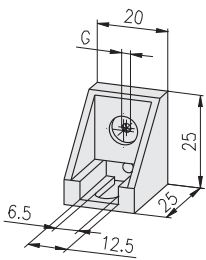

Description	G	Colour	Weight	Article-No.
Mounting block screw type	M3	grey	9 g	1.64.10M3.1
Mounting block screw type	M3	black	9 g	1.64.10M3.2
Mounting block screw type	M4	grey	9 g	1.64.10M4.1
Mounting block screw type	M4	black	9 g	1.64.10M4.2
Mounting block screw type	M5	grey	9 g	1.64.10M5.1
Mounting block screw type	M5	black	9 g	1.64.10M5.2
Mounting block screw type	M6	grey	9 g	1.64.10M6.1
Mounting block screw type	M6	black	9 g	1.64.10M6.2

**Mounting block GD-Zn**

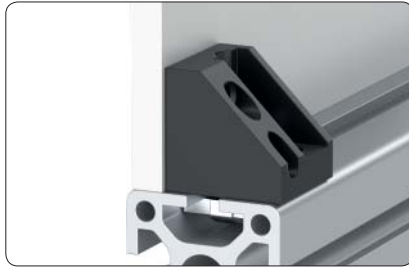

**Application**  
For mounting of panels

**Technical data**  
material: GD-Zn

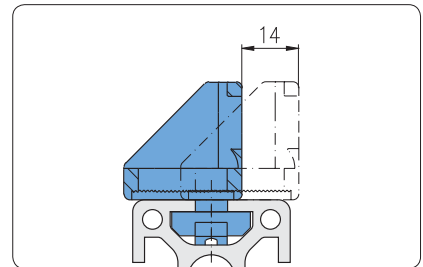
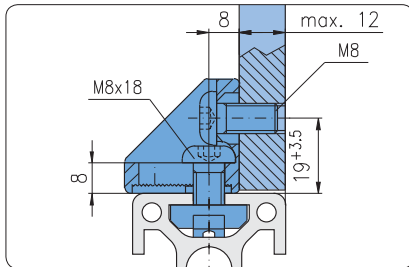
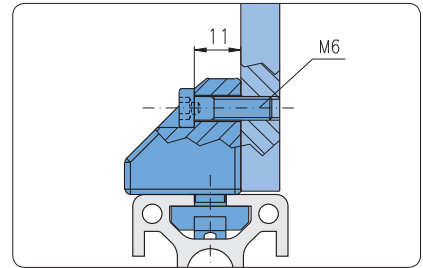
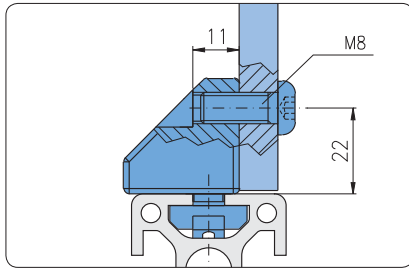
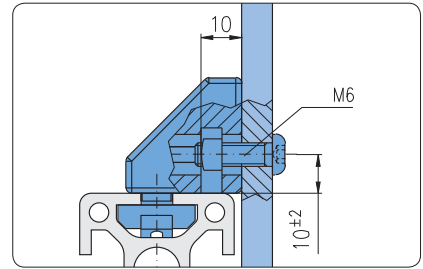
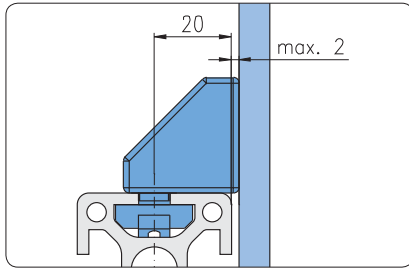

Anti-twistable mounting in steps of 1 mm

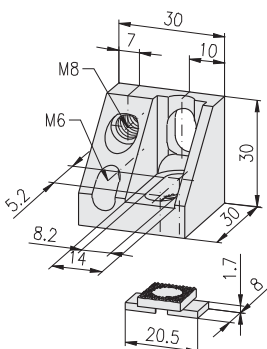
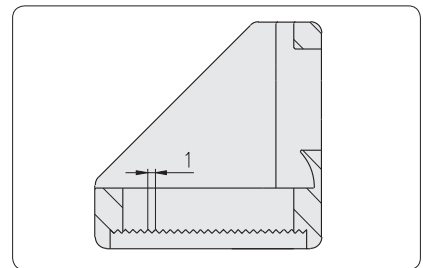

Description	G	Surface	Weight	Article-No.
Mounting block GD-Zn	M8	natural	68 g	1.64.153030.1
Mounting block GD-Zn	M8	black	68 g	1.64.153030.2

Mounting blocks for subsequent insertion



Application

For the mounting of panels with subsequent insertion  
Variable mounting position of panels with distancing plate

Mounting block H

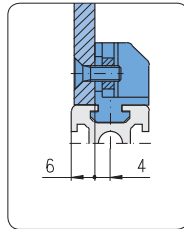
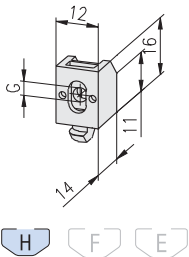

H-slot

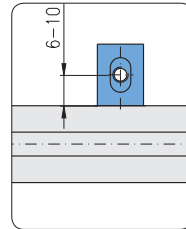

Tolerance equalisation: 4 mm

Technical data

material: PA-GF  
colour: black  
square nut: steel, galvanised  
max. static load: 100 N, rectangular to slot

Description	G	Weight	Article-No.
Mounting block H	M4	2.6 g	1.64.2H2M4.2

Technical data

material: PA-GF  
colour: black

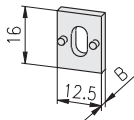

Description	B	Weight	Article-No.
Distancing plate for mounting block H	1	0.2 g	1.64.xH01
Distancing plate for mounting block H	2	0.4 g	1.64.xH02
Distancing plate for mounting block H	3	0.6 g	1.64.xH03
Distancing plate for mounting block H	4	0.8 g	1.64.xH04

Mounting blocks F and E

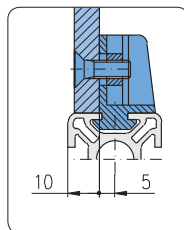

F-slot

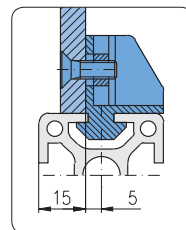

E3-slot

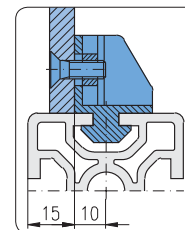

E4-slot

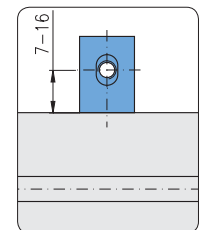

Tolerance equalisation: 9 mm

Technical data

material: PA-GF  
colours: grey, black  
square nut: steel, galvanised  
max. static load: 250 N, rectangular to slot

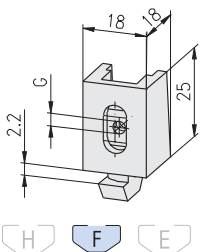

Description	G	Colour	Weight	Article-No.
Mounting block F	M4	grey	9 g	1.64.2F2M4.1
Mounting block F	M4	black	9 g	1.64.2F2M4.2
Mounting block F	M5	grey	9 g	1.64.2F2M5.1
Mounting block F	M5	black	9 g	1.64.2F2M5.2
Mounting block F	M6	grey	9 g	1.64.2F2M6.1
Mounting block F	M6	black	9 g	1.64.2F2M6.2

Mounting blocks E

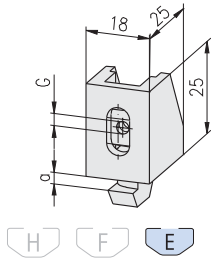

Description	G	Colour	a	Weight	Article-No.
Mounting block E3	M4	grey	3.0	10.5 g	1.64.2E3M4.1
Mounting block E3	M4	black	3.0	10.5 g	1.64.2E3M4.2
Mounting block E3	M5	grey	3.0	10.1 g	1.64.2E3M5.1
Mounting block E3	M5	black	3.0	10.1 g	1.64.2E3M5.2
Mounting block E3	M6	grey	3.0	9.6 g	1.64.2E3M6.1
Mounting block E3	M6	black	3.0	9.6 g	1.64.2E3M6.2
Mounting block E4	M4	grey	4.0	10.6 g	1.64.2E4M4.1
Mounting block E4	M4	black	4.0	10.6 g	1.64.2E4M4.2
Mounting block E4	M5	grey	4.0	10.2 g	1.64.2E4M5.1
Mounting block E4	M5	black	4.0	10.2 g	1.64.2E4M5.2
Mounting block E4	M6	grey	4.0	9.9 g	1.64.2E4M6.1
Mounting block E4	M6	black	4.0	9.9 g	1.64.2E4M6.2

Technical data

material: PA-GF  
colours: grey, black

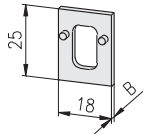

Description	B	Colour	Weight	Article-No.
Distancing plate for mounting block FE	2	grey	0.5 g	1.64.2x02.1
Distancing plate for mounting block FE	2	black	0.5 g	1.64.2x02.2
Distancing plate for mounting block FE	3	grey	0.8 g	1.64.2x03.1
Distancing plate for mounting block FE	3	black	0.8 g	1.64.2x03.2
Distancing plate for mounting block FE	5	grey	1.3 g	1.64.2x05.1
Distancing plate for mounting block FE	5	black	1.3 g	1.64.2x05.2

Distancing plate, thin



Application

For the mounting of folded panels

Technical data

material: PA-GF  
colours: grey, black

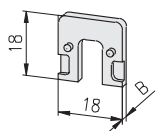
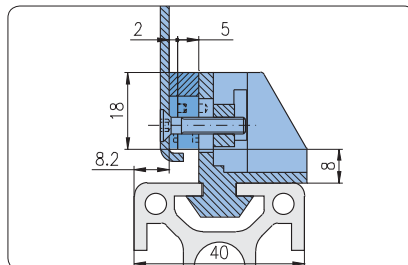

Description	B	Colour	Weight	Article-No.
Distancing plate, thin, for mounting block FE	2	grey	0.3 g	1.64.2x102.1
Distancing plate, thin, for mounting block FE	2	black	0.3 g	1.64.2x102.2
Distancing plate, thin, for mounting block FE	3	grey	0.6 g	1.64.2x103.1
Distancing plate, thin, for mounting block FE	3	black	0.6 g	1.64.2x103.2
Distancing plate, thin, for mounting block FE	5	grey	0.9 g	1.64.2x105.1
Distancing plate, thin, for mounting block FE	5	black	0.9 g	1.64.2x105.2

**Mounting clamp blocks for subsequent insertion**



**Application**

Mounting of panels with clamps, without drilling and screwing  
 For subsequent insertion:  
 Variable mounting position of panels with distance plates



The distance plates are positioned and fastened by pins, it is possible to mount several distance plates in series

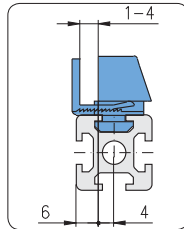

H-slot

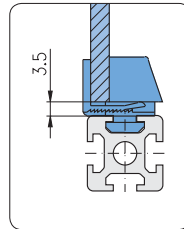

Installation dimensions

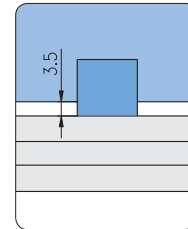

Installation dimensions

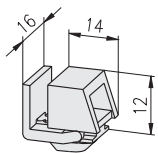

**Technical data**

material: PA-GF  
 colour: black  
 max. static load:  
 • towards clamp block: 110 N  
 • towards slider: 30 N

**Description**

Mounting clamp block H

**Weight**

3.4 g

**Article-No.**

1.64.3H2

**Technical data**

material: PA-GF  
 colour: black

**Description**

Description	B	Weight	Article-No.
Distancing plate for mounting clamp block H	1	0.2 g	1.64.xH01
Distancing plate for mounting clamp block H	2	0.4 g	1.64.xH02
Distancing plate for mounting clamp block H	3	0.6 g	1.64.xH03
Distancing plate for mounting clamp block H	4	0.8 g	1.64.xH04

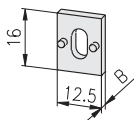

**Mounting clamp blocks for subsequent insertion**

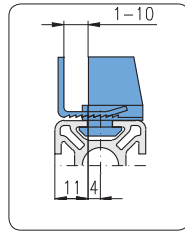

F-slot

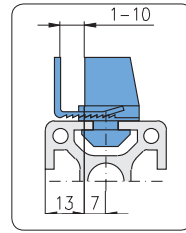

E3-slot

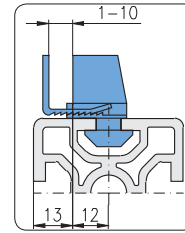

E4-slot

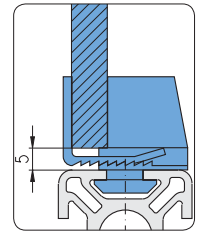

Installation dimensions

**Technical data**

material: PA-GF

colour: black

max. static load:

- towards clamp block: 250 N
- towards slider: 50 N

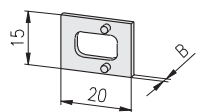
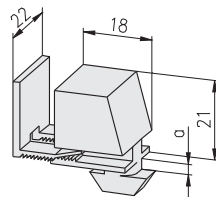
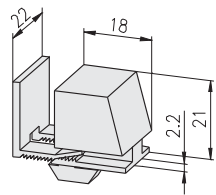

**Description**

Mounting clamp block F

**Weight**

7.5 g

**Article-No.**

1.64.3F2

**Description**

Mounting clamp block E3

**a**

3.0

**Weight**

8.0 g

**Article-No.**

1.64.3E3

Mounting clamp block E4

4.0

8.0 g

1.64.3E4

**Technical data**

material: PA-GF

colour: black

**Description**

Distancing plate for mounting clamp block FE

**B**

2

**Weight**

0.6 g

**Article-No.**

1.64.3x02

Distancing plate for mounting clamp block FE

3

0.9 g

1.64.3x03

Distancing plate for mounting clamp block FE

5

1.4 g

1.64.3x05



Mounting clamp blocks SL for subsequent insertion

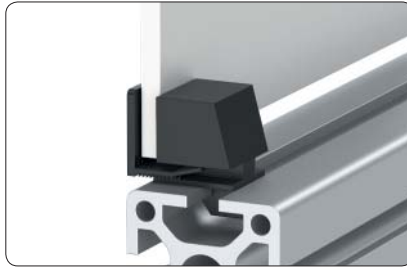

Application

As mounting clamp block, however: For safety's sake it is only possible to be opened with special tools

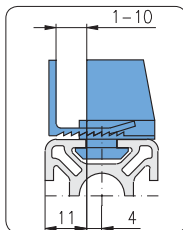

F-slot

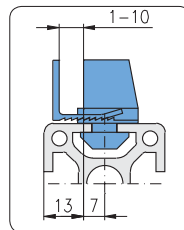

E3-slot

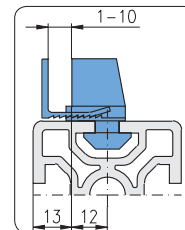

E4-slot

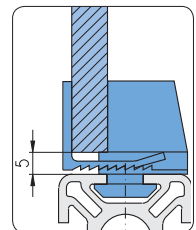

Installation dimensions

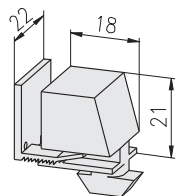

Technical data

- material: PA-GF
- colour: black
- max. static load:
  - towards clamp block: 250 N
  - towards slider: 50 N

Description

Description	Weight	Article-No.
Mounting clamp block F, SL	7.5 g	1.64.4F2
Mounting clamp block E3, SL	8.0 g	1.64.4E3
Mounting clamp block E4, SL	8.0 g	1.64.4E4

Technical data

- material: PA-GF
- colour: black

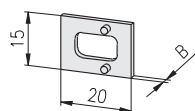

Description

Description	B	Weight	Article-No.
Distancing plate for mounting clamp block FE	2	0.6 g	1.64.3x02
Distancing plate for mounting clamp block FE	3	0.9 g	1.64.3x03
Distancing plate for mounting clamp block FE	5	1.4 g	1.64.3x05

Technical data

- material: PA-GF
- colour: red
- steel bolt: hardened

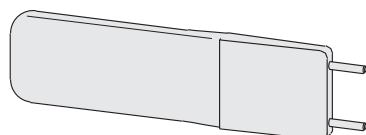

Description

Description	Weight	Article-No.
Tool for mounting clamp block SL	23 g	1.64.4W

Quick locks

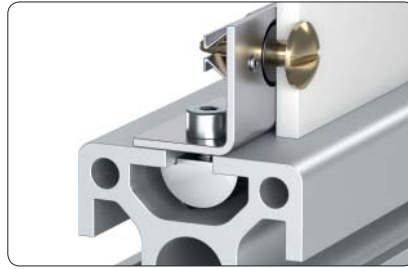

Application

Mounting element for quick mounting and dismounting of covers

Comments

open: by 1/4-turn  
close: by push in

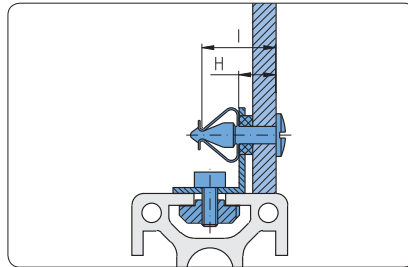

Fastening without washer  
 $H_{max} = S_{retaining\ ring} + \text{panel thickness}$

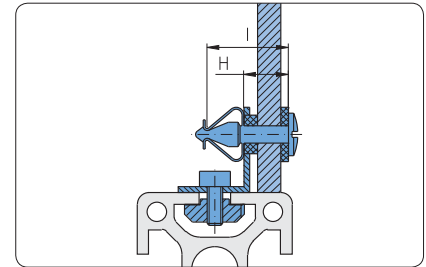

Fastening with washer  
 $H_{max} = S_{retaining\ ring} + \text{panel thickness} + S_{washer}$

Technical data (assembly)

drilling diameter  
in the covers: 7 mm  
max. static load: 900 N  
life time: ca. 10.000 operations

Mounting angle

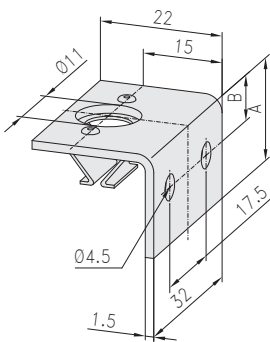

Technical data

material: steel  
surface: galvanised

Mounting elements:

- F-slot:
- T-Nut, with leaf spring F, 2xM4 1.32.4F2M4.25
  - threaded plate F, M4 1.31.FM4
  - spring nut F, M4 1.33.FM4
  - T-slot nut F, M4 1.34.10FM4
- E-slot:
- T-Nut, with leaf spring E, 2xM4 1.32.4E2M4.25
  - spring nut E, M4 1.33.EM4
  - T-slot nut E, M4 1.34.10EM4
  - rhomboid T-slot nut E, M4 1.34.20EM4

Description	A	B	Weight	Article-No.
Mounting angle	18.3	8.9	14,6 g	1.64.5101
Mounting angle	24.5	14.7	16,4 g	1.64.5102
Mounting angle	29.8	18.9	19,0 g	1.64.5103

Retaining rings

Technical data

material: neoprene  
hardness: 55 Shore A  
temperature range: - 50°C to + 90°C

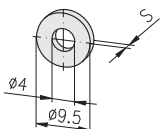

Description	S	Weight	Article-No.
Retaining ring	1.7	1.3 g	1.64.5217
Retaining ring	2.5	1.8 g	1.64.5225
Retaining ring	4.0	3.5 g	1.64.5240
Retaining ring	5.0	4.0 g	1.64.5250
Retaining ring	6.0	4.5 g	1.64.5260

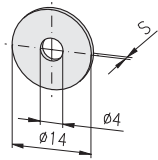
**Sealing washers**

**Technical data**

material: neoprene  
 hardness: 55 Shore A  
 temperature range: - 50°C to + 90°C

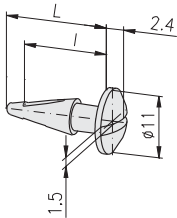
Description	S	Weight	Article-No.
Sealing washer	0.5	0.8 g	1.64.5305
Sealing washer	1.0	1.7 g	1.64.5310
Sealing washer	1.5	2.5 g	1.64.5315
Sealing washer	2.0	3.3 g	1.64.5320

**Round head bolts**

**Technical data**

material: brass  
 surface: nickel-plated

**Comments**

Mounting dimension „H“ see mounting sketch

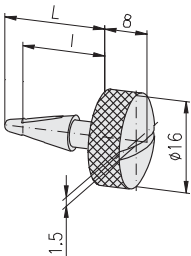
Description	H <sub>max</sub>	L	I	Weight	Article-No.
Round head bolt	3.7	16.6	14.4	4.0 g	1.64.5416
Round head bolt	4.7	17.6	15.4	4.0 g	1.64.5417
Round head bolt	5.7	18.6	16.4	4.0 g	1.64.5418
Round head bolt	6.9	19.8	17.6	4.5 g	1.64.5419
Round head bolt	7.7	20.6	18.4	5.0 g	1.64.5420
Round head bolt	8.9	21.8	19.6	5.0 g	1.64.5421
Round head bolt	9.7	22.6	20.4	6.0 g	1.64.5422
Round head bolt	10.7	23.6	21.4	6.0 g	1.64.5423

**Knurled head bolts**

**Technical data**

material: brass  
 surface: nickel-plated

**Comments**

Mounting dimension „H“ see mounting sketch

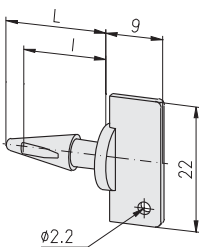
Description	H <sub>max</sub>	L	I	Weight	Article-No.
Knurled head bolt	3.7	16.6	14.4	14.0 g	1.64.5516
Knurled head bolt	4.7	17.6	15.4	14.0 g	1.64.5517
Knurled head bolt	5.7	18.6	16.4	14.0 g	1.64.5518
Knurled head bolt	6.9	19.8	17.6	14.0 g	1.64.5519
Knurled head bolt	7.7	20.6	18.4	15.0 g	1.64.5520
Knurled head bolt	8.9	21.8	19.6	15.0 g	1.64.5521
Knurled head bolt	10.7	23.6	21.4	15.0 g	1.64.5523

**Wing head bolts**

**Technical data**

material: brass  
 surface: nickel-plated

**Comments**

Mounting dimension „H“ see mounting sketch

Description	H <sub>max</sub>	L	I	Weight	Article-No.
Wing head bolt	3.7	16.6	14.4	5.8 g	1.64.5616
Wing head bolt	4.7	17.6	15.4	5.8 g	1.64.5617
Wing head bolt	5.7	18.6	16.4	5.8 g	1.64.5618
Wing head bolt	6.9	19.8	17.6	5.8 g	1.64.5619
Wing head bolt	7.7	20.6	18.4	6.3 g	1.64.5620
Wing head bolt	8.9	21.8	19.6	6.3 g	1.64.5621
Wing head bolt	9.7	22.6	20.4	6.3 g	1.64.5622
Wing head bolt	10.7	23.6	21.4	6.3 g	1.64.5623

**Bullet catches**



**Application**

Lock for swinging and sliding doors

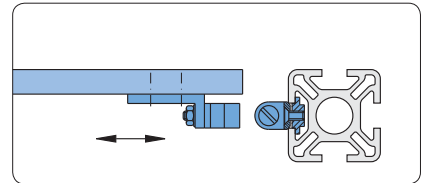
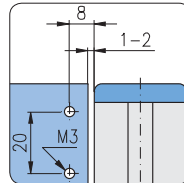
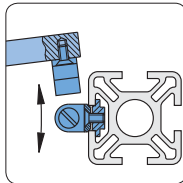

**Technical data**

material: brass, natural  
bullet: stainless steel  
retention force: adjustable

**Comments**

Countersink DIN 74 - M4 for countersunk screw DIN 7991 - M4

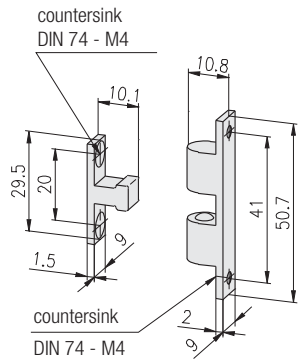

**Description**

Bullet catch 9x50

**Weight**

25.0 g

**Article-No.**

1.65.1101

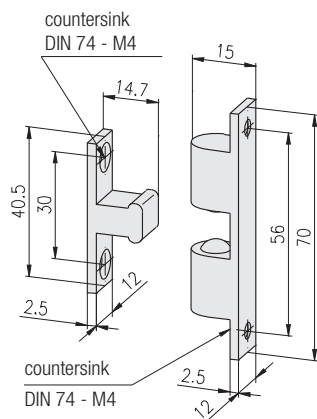

**Comments**

Countersink DIN 74 - M4 for countersunk screw DIN 7991 - M4

**Description**

Bullet catch 12x70

**Weight**

72.0 g

**Article-No.**

1.65.1102

**Bullet catch PA**

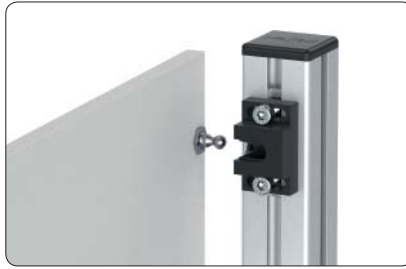

**Application**

Lock for swinging and sliding doors

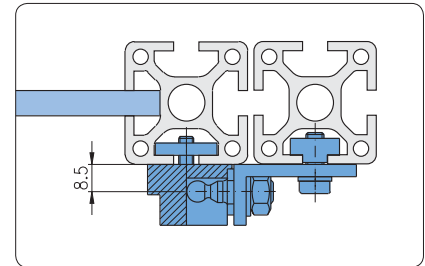
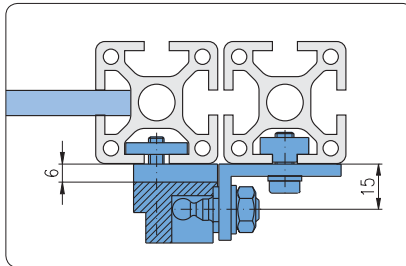
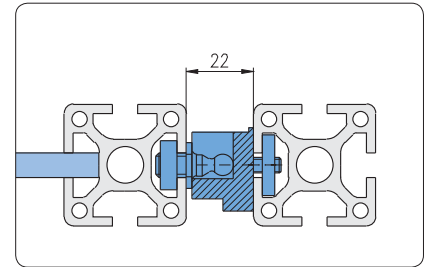
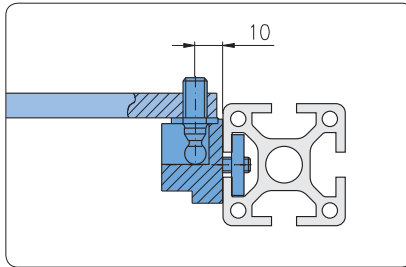

Fastening of the bolt with angle 25×40, Ø8.7 ↗ 1.46.115

Fastening of the bolt with angle 20×47, M8 ↗ 1.65.1301

**Bullet catch PA**

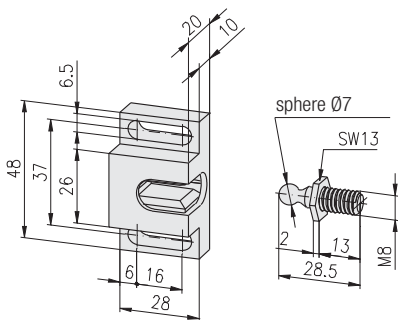

**Technical data**

capsule: PA-GF, black  
 bolt: steel, galvanised  
 retention force: 45 N

Description	Weight	Article-No.
Bullet catch PA	23.0 g	1.65.1201

**Angle**

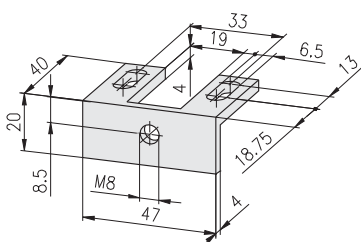

**Technical data**

material: aluminium  
 strength: F22  
 surface: natural anodised

Description	Weight	Article-No.
Angle 20×47, M8	16.0 g	1.65.1301

**Magnetic lock PA**



**Application**

Lock for swinging and sliding doors

**Technical data**

capsule: PA-GF, black  
 flat head screw: steel, galvanised  
 retention force: y = 40 N  
 x = 25 N

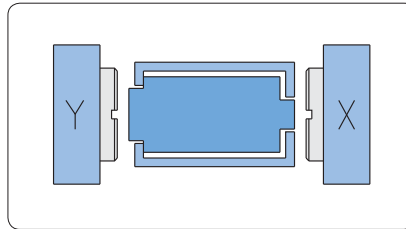

**Comments**

Different force  
 y = large force  
 x = small force

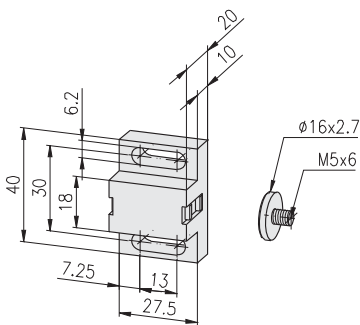
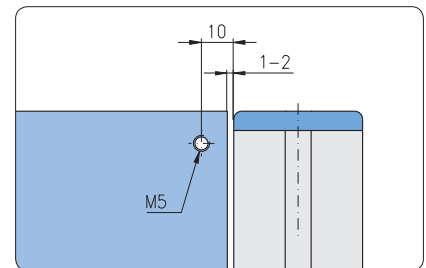
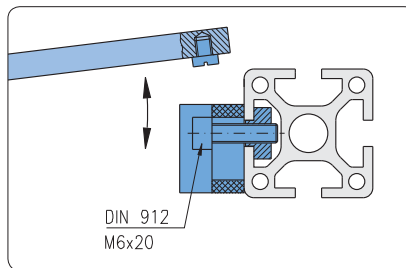

**Description**

Magnetic lock PA

**Weight**

38.0 g

**Article-No.**

1.65.2101

**Angle bracket**  
 for magnetic lock PA

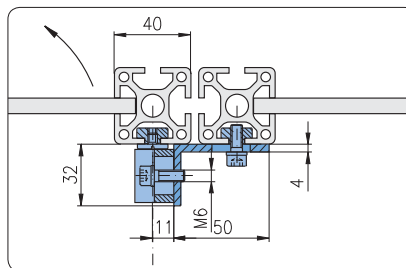

**Technical data**

material: aluminium  
 strength: F22  
 surface: natural anodised

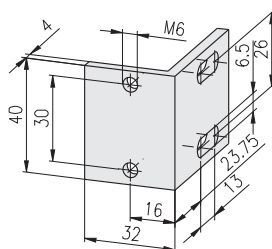

**Description**

Angle bracket for magnetic lock PA

**Weight**

32.0 g

**Article-No.**

1.65.2301

Lock GD-Zn



**Application**

Lock with sprung bolt for easy closing of doors and panels, including separate slot fastening capability

**Technical data**

capsule: GD Zn, painted silver  
 handle: PA, black  
 bolt: stainless steel

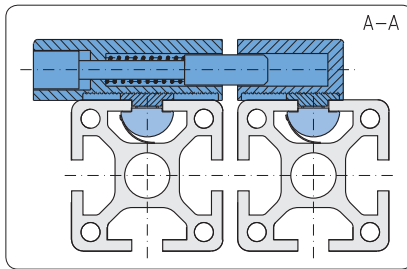

Slot fastening capability

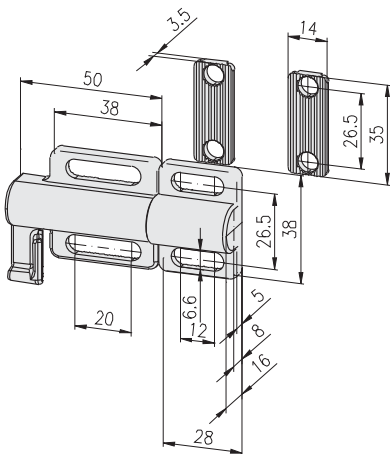
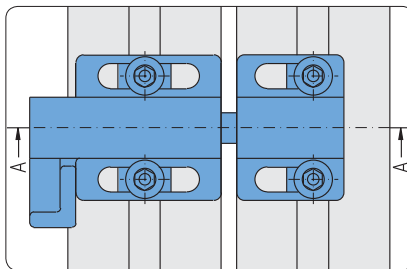

**Description**

Lock GD-Zn

**Weight**

120.0 g

**Article-No.**

1.65.2538078

Cylinder locks



Application

Locking system for swinging and sliding doors

Technical data

capsule: GD Zn, galvanised  
tongue, nut, screw: steel, galvanised

Mounting position

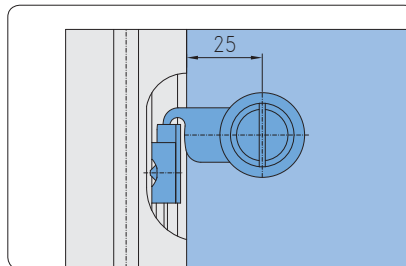

Left, with tongue left, latch left

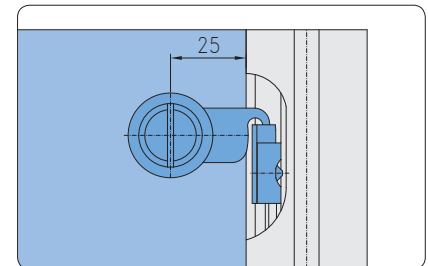

Right, with tongue right, latch right

Mounting variants

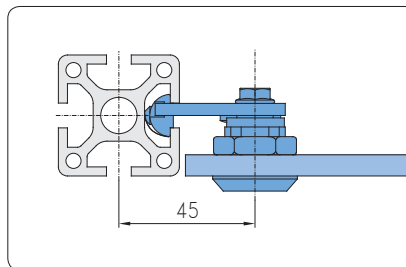

Swinging door without profile frame mounting position left

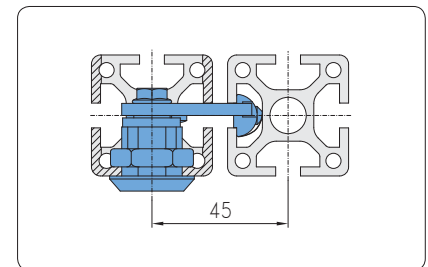

Swinging door with profile frame made of profile 40×40, mounting position right

Installation dimensions

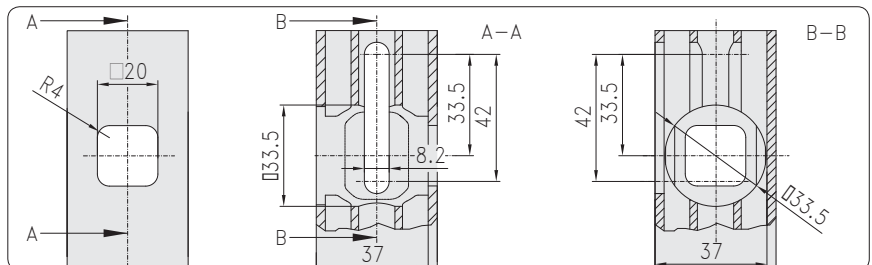
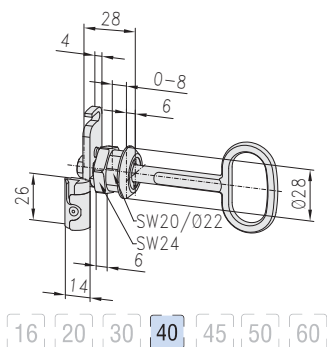
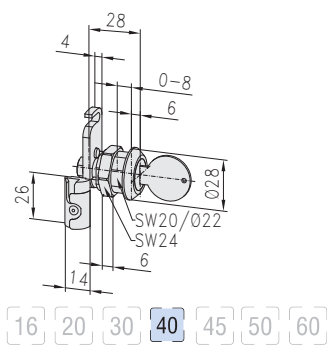

Description

Cylinder lock with 2 keys, left  
Cylinder lock with 2 keys, right

Weight

82.0 g  
82.0 g

Article-No.

1.65.3101.L  
1.65.3101.R

Comments

Key with double beard Ø8 mm

Description

Cylinder lock with double beard insert, left  
Cylinder lock with double beard insert, right

Weight

100.0 g  
100.0 g

Article-No.

1.65.3102.L  
1.65.3102.R



Cylinder locks with security latch



**Application**  
Lock for swinging door

**Comments**  
Security latch  
Jolting- and vibrationless by integral lock

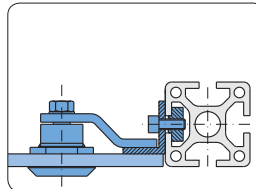

Installation variant with mounting angle

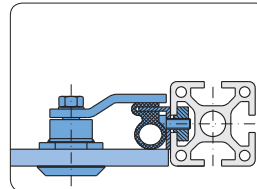

Installation variant with seal

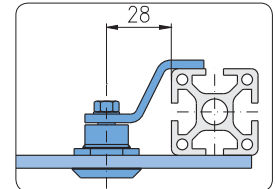

Installation variant

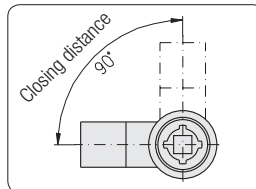

Closing distance

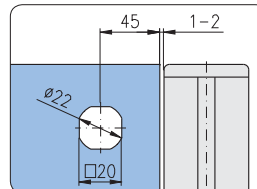

Drilling pattern

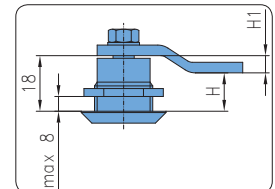

Security latch dimension  
H1 = 18 - H

Cylinder locks

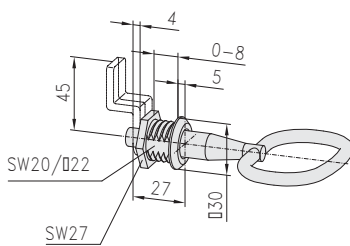
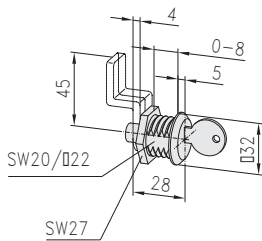

**Technical data**

capsule: GD Zn, galvanised  
tongue, nut, screw: steel, galvanised

**Description**

Cylinder lock with 2 keys, without security latch

**Weight**

66 g

**Article-No.**

1.65.3201

**Comments**

Socket wrench / square 8 mm

**Description**

Cylinder lock with 1 square key, without security latch

**Weight**

100 g

**Article-No.**

1.65.3202

Security latches

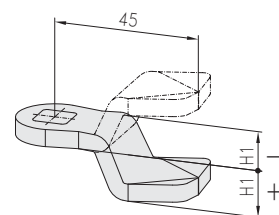

Description	H1	Weight	Article-No.
Security latch 45	14	29.5 g	1.65.3204
Security latch 45	12	28.5 g	1.65.3206
Security latch 45	10	27.5 g	1.65.3208
Security latch 45	8	27.0 g	1.65.3210
Security latch 45	5	26.5 g	1.65.3213
Security latch 45	4	26.0 g	1.65.3214
Security latch 45	2	27.0 g	1.65.3216
Security latch 45	0	26.5 g	1.65.3218
Security latch 45	-2	26.5 g	1.65.3220
Security latch 45	-4	26.0 g	1.65.3222
Security latch 45	-6	26.5 g	1.65.3224
Security latch 45	-7	27.5 g	1.65.3225
Security latch 45	-8	28.0 g	1.65.3226

Description	H1	Weight	Article-No.
Security latch 45	-10	26.5 g	1.65.3228
Security latch 45	-12	27.5 g	1.65.3230
Security latch 45	-14	28.5 g	1.65.3232
Security latch 45	-16	32.0 g	1.65.3234
Security latch 45	-17	34.5 g	1.65.3235
Security latch 45	-18	33.5 g	1.65.3236
Security latch 45	-20	35.0 g	1.65.3238
Security latch 45	-22	35.5 g	1.65.3240
Security latch 45	-24	36.0 g	1.65.3242
Security latch 45	-26	37.5 g	1.65.3244
Security latch 45	-27	36.0 g	1.65.3245
Security latch 45	-29	38.0 g	1.65.3247
Security latch 45	-32	39.0 g	1.65.3250

**Flap-lock countersunk for sliding door**



**Application**  
Lock for sliding door

**Technical data**  
capsule: GD Zn, chrome-plated  
tongue and nut: steel, galvanised

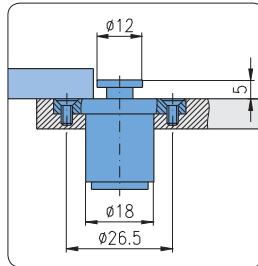
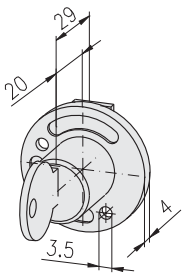

Locked

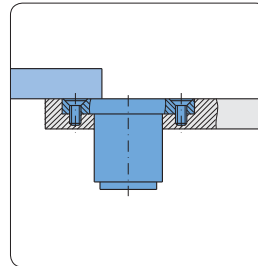

Open

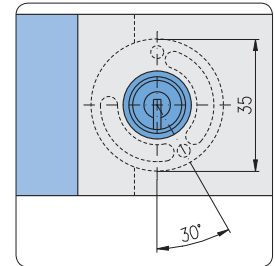

Description	Weight	Article-No.
Flap-lock countersunk, for sliding door	52 g	1.65.3301

**Cylinder locks flush**



**Application**  
Locking system for swinging doors

**Technical data**  
locking: 90°  
material:  
• capsule: GD Zn, chrome-plated  
• fixing plate: GD Zn, black powder-coated

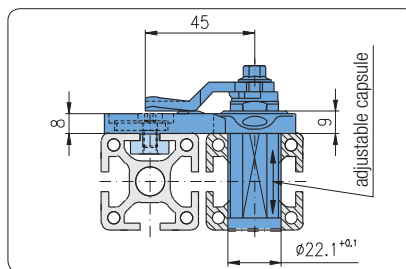

Outside: flush  
(without jutout of lock parts)

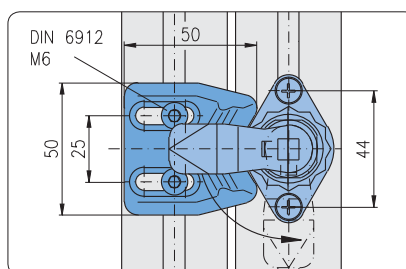
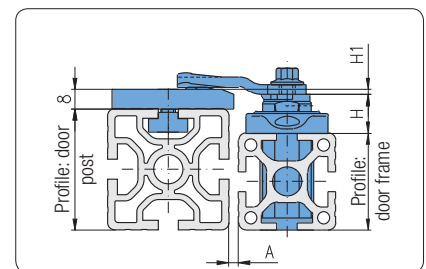

Inside: with fixing plate

Profile		Latch		
Door post	Door frame	A	H	H1
40	40	1.6	16	-8
	45	1.6	16	-2
50	45	1.8	21	-12
	50	2.0	16	-8
	60	2.0	16	-8
60	40	1.6	16	12
	45	1.8	21	2
	50	2.0	16	2
	60	3.0	16	-8

**Cylinder locks flush**

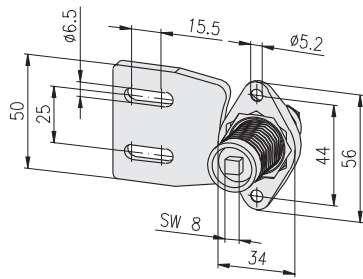

**Delivery unit**

- cylinder lock with fixing plate

**Separate order**

- key
- security latch

Description	GL	Weight	Article-No.
Cylinder lock flush, square	56	194.0 g	1.65.34156
Cylinder lock flush, square	66	212.8 g	1.65.34166
Cylinder lock flush, square	76	231.6 g	1.65.34176

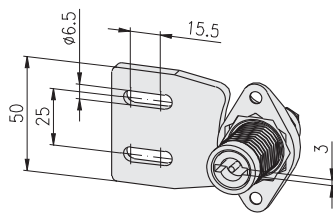

**Delivery unit**

- cylinder lock with fixing plate

**Separate order**

- key
- security latch

Description	GL	Weight	Article-No.
Cylinder lock flush, double beard	56	193.8 g	1.65.34356
Cylinder lock flush, double beard	66	204.1 g	1.65.34366
Cylinder lock flush, double beard	76	214.4 g	1.65.34376

**Square keys**

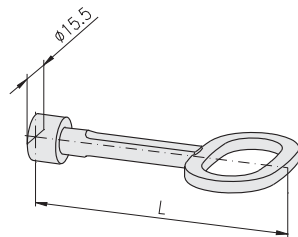

Description	L	Material	Weight	Article-No.
Square key 8, 40 mm		PA-GF	7.5 g	1.65.34540
Square key 8, 81 mm		GD Zn	41.6 g	1.65.34581

**Double beard keys**

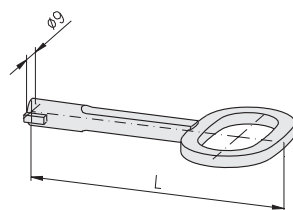

Description	L	Material	Weight	Article-No.
Double beard key 3, 40 mm		PA-GF	6.4 g	1.65.34740
Double beard key 3, 89 mm		GD Zn	35.8 g	1.65.34789

**Security latches**

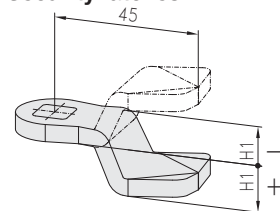

Description	H1	Weight	Article-No.
Security latch 45	12	30.3 g	1.65.3206
Security latch 45	2	26.8 g	1.65.3216
Security latch 45	-2	27.4 g	1.65.3220
Security latch 45	-8	27.3 g	1.65.3226
Security latch 45	-12	30.3 g	1.65.3230

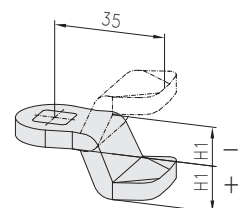

Description	H1	Weight	Article-No.
Security latch 35	2	20.4 g	1.65.3493502.1
Security latch 35	-2	20.1 g	1.65.3493502.2
Security latch 35	-8	22.5 g	1.65.3493508.2
Security latch 35	12	22.9 g	1.65.3493512.1
Security latch 35	-12	22.9 g	1.65.3493512.2

**Mortise deadlocks**



**Application**

Door locks for doors with profile frames made from profiles 40×40 and 45×45

**Technical data**

mortise deadlock: steel, galvanised  
 screws and threaded plates: steel, galvanised  
 lock insert: GD-Zn, galvanised  
 rosette: LM, natural anodised  
 case: Al Mg Si 0.5 F25, natural anodised



Door lock without lock insert and handles both sides



Door lock with cylinder lock and handles both sides



Door lock with lock insert, one handle and one fixed knob

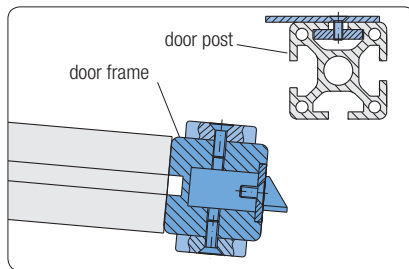

Mounting position left

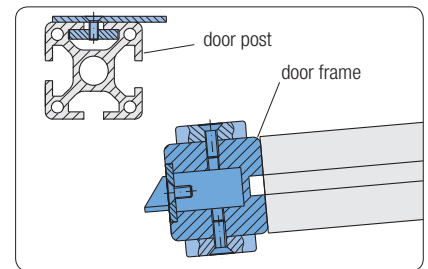

Mounting position right

**Profile machining**  
for door post

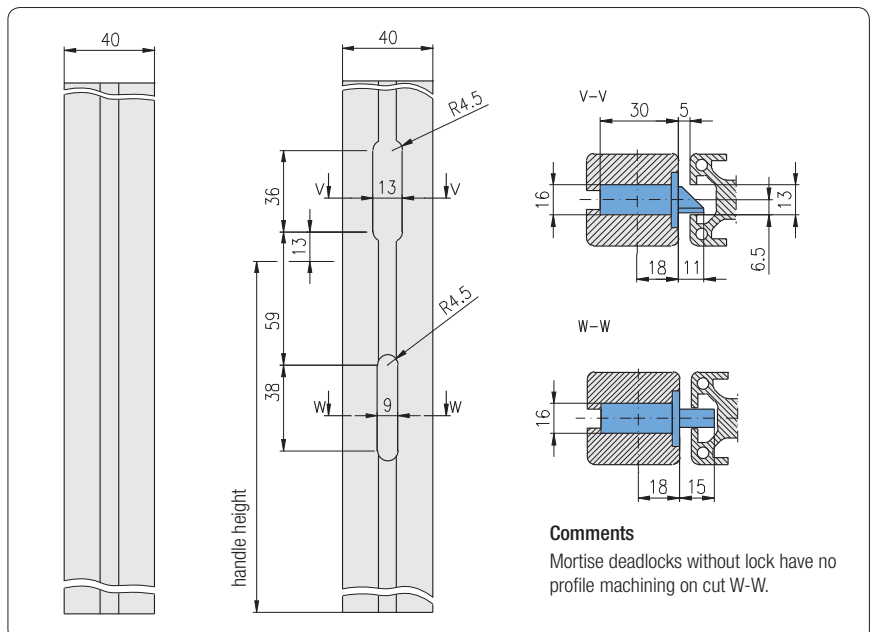

**Comments**

Mortise deadlocks without lock have no profile machining on cut W-W.

**Mortise deadlock installation sets**  
without lock

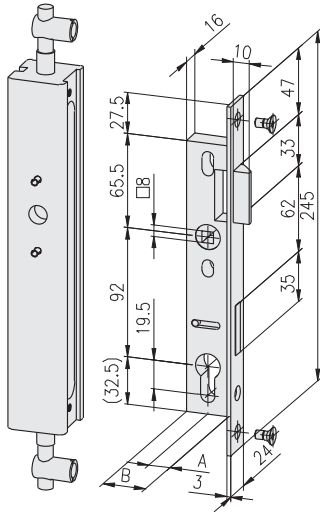

**Comments**

Drawing shows mounting position left,  
mirror image mounting position right

Description	Weight	Article-No.
Mortise deadlock installation set without lock, left, PG 40	1,191 g	1.65.4001L40
Mortise deadlock installation set without lock, right, PG 40	1,191 g	1.65.4001R40
Mortise deadlock installation set without lock, left, PG 45	1,352 g	1.65.4001L45
Mortise deadlock installation set without lock, right, PG 45	1,352 g	1.65.4001R45

**Single parts**

Description	Pcs.	Weight	Article-No.
Mortise deadlock case without lock PG 40	1	665 g	1.65.4101x40
Mortise deadlock case without lock PG 45	1	790 g	1.65.4101x45
Mortise deadlock left, PG 40	1	412 g	1.65.4211L40
Mortise deadlock right, PG 40	1	412 g	1.65.4211R40
Mortise deadlock left, PG 45	1	430 g	1.65.4211L45
Mortise deadlock right, PG 45	1	430 g	1.65.4211R45
Screw connector PG 40	2	55 g	1.21.4S1M8/11
Screw connector PG 45	2	64 g	1.21.4S1M8/11
Countersunk screw DIN 7991 - M5x12	2	2 g	0.63.D07991.05012

**Mortise deadlock cases**  
without lock

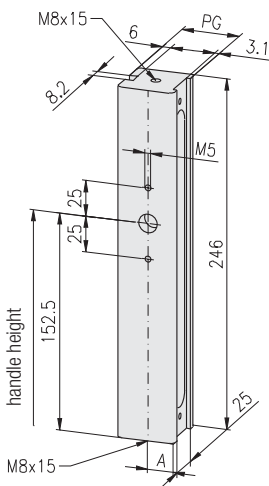

Description	A	B	Weight	Article-No.
Mortise deadlock case without lock				
mounting position le/ri, PG 40	18	30	665 g	1.65.4101x40
mounting position le/ri, PG 45	20	32	790 g	1.65.4101x45

**Mortise deadlock installation sets**  
with lock

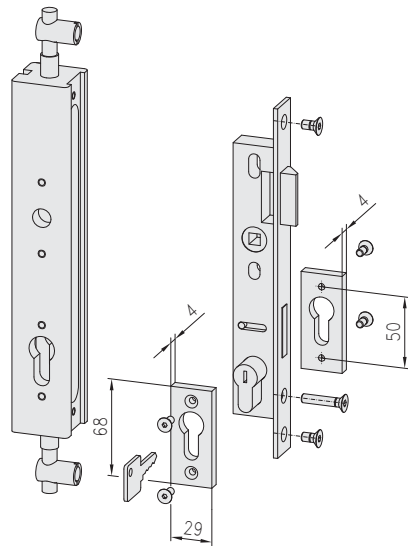

Dimensions → 276, drawing „Mortise deadlock installation sets without lock“

**Comments**

Drawing shows mounting position left, mirror image mounting position right

Description	Weight	Article-No.
Mortise deadlock installation set with lock, left, PG 40	1,371 g	1.65.4002L40
Mortise deadlock installation set with lock, right, PG 40	1,371 g	1.65.4002R40
Mortise deadlock installation set with lock, left, PG 45	1,535 g	1.65.4002L45
Mortise deadlock installation set with lock, right, PG 45	1,535 g	1.65.4002R45

**Single parts**

Description	Pcs.	Weight	Article-No.
Mortise deadlock case with lock PG 40	1	620 g	1.65.4102x40
Mortise deadlock case with lock PG 45	1	740 g	1.65.4102x45
Mortise deadlock left, PG 40	1	412 g	1.65.4211L40
Mortise deadlock right, PG 40	1	412 g	1.65.4211R40
Mortise deadlock left, PG 45	1	430 g	1.65.4211L45
Mortise deadlock right, PG 45	1	430 g	1.65.4211R45
Screw connector PG 40	2	55 g	1.21.4S1M8/11
Screw connector PG 45	2	64 g	1.21.4S1M8/11
Lock insert with 2 keys, PG 40	1	188 g	1.65.421240
Lock insert with 2 keys, PG 45	1	196 g	1.65.421245
Countersunk screw DIN 7991 - M5×12	2	2 g	0.63.D07991.05012
Countersunk screw DIN 7991 - M5×30	1	4 g	0.63.D07991.05030
Rosette, set	1	25 g	1.65.4213
Countersunk screw DIN 7991 - M5×12	4	2 g	0.63.D07991.05012

**Mortise deadlock cases**  
with lock

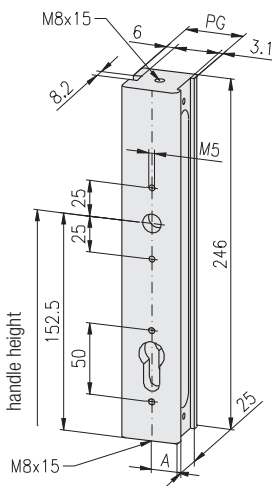

Description	A	B	Weight	Article-No.
Mortise deadlock case with lock mounting position L/R, PG 40	18	30	620 g	1.65.4102x40
Mortise deadlock case with lock mounting position L/R, PG 45	20	32	740 g	1.65.4102x45

**Door handle**

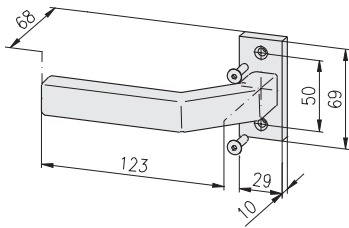

**Technical data**

material: LM  
surface: natural anodised

Description	Weight	Article-No.
Door handle set	166 g	1.65.4220

**Single parts**

Description	Pcs.	Weight	Article-No.
Handle with rosette	1	160 g	1.65.4221
Countersunk screw DIN 7991 - M5×20	2	3 g	0.63.D07991.05020

**Door knob**

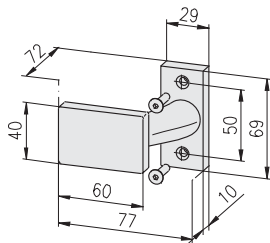

**Technical data**

material: LM  
surface: natural anodised

**Comments**

Door knob fixed

Description	Weight	Article-No.
Door knob set	178 g	1.65.4230

**Single parts**

Description	Pcs.	Weight	Article-No.
Door knob with rosette	1	172 g	1.65.4231
Countersunk screw DIN 7991 - M5×20	2	3 g	0.63.D07991.05020

**Push pins**

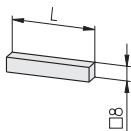

**Technical data**

material: steel  
surface: galvanised

**Comments**

Stop pin for 1 door handle variant only

Description	L	Weight	Article-No.
Push pin for 1 door handle, PG 40	56	28 g	1.65.425140
Push pin for 1 door handle, PG 45	58.5	29 g	1.65.425145

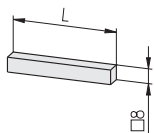

Description	L	Weight	Article-No.
Push pin for 2 door handles, PG 40	94	54 g	1.65.425240
Push pin for 2 door handles, PG 45	99	57 g	1.65.425245

Bar locks



Bar lock with olive



Bar lock with socket wrench

**Application**

Lock for large doors made of profile 30×60 or 40×80, with pin arrest on top and bottom side

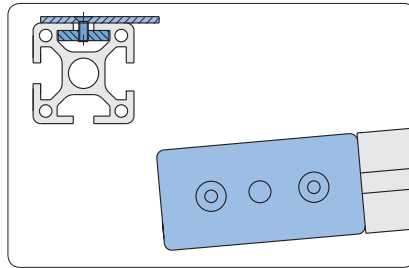

Mounting position right

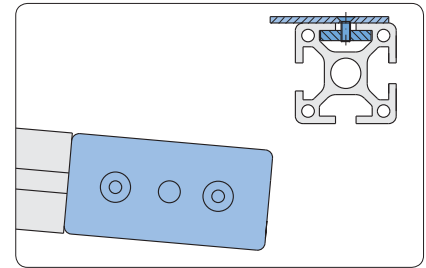

Mounting position left

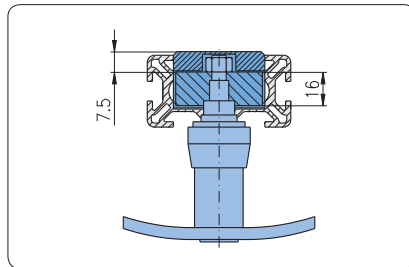

Mounting in profile 30×60

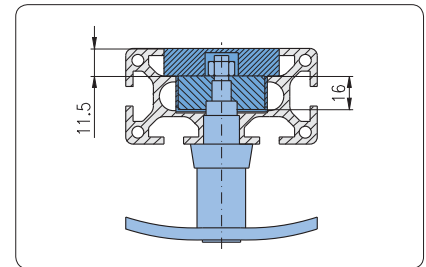

Mounting in profile 40×80



**Profile machining 30×60**  
for bar lock

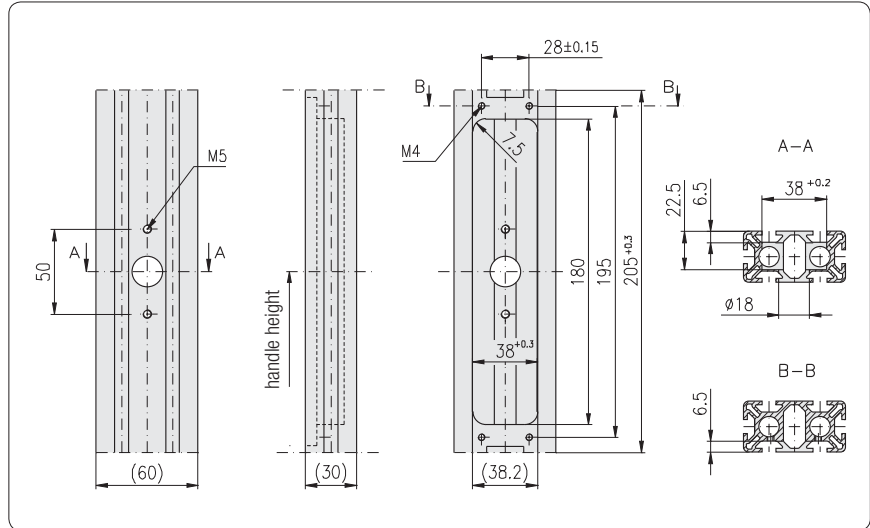
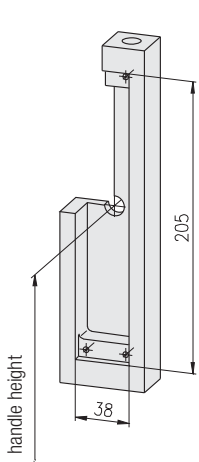

**Description**

Profile machining 30×60 for bar lock

**Article-No.**

1.65.5110

**Profile machining 40×80**  
for bar lock

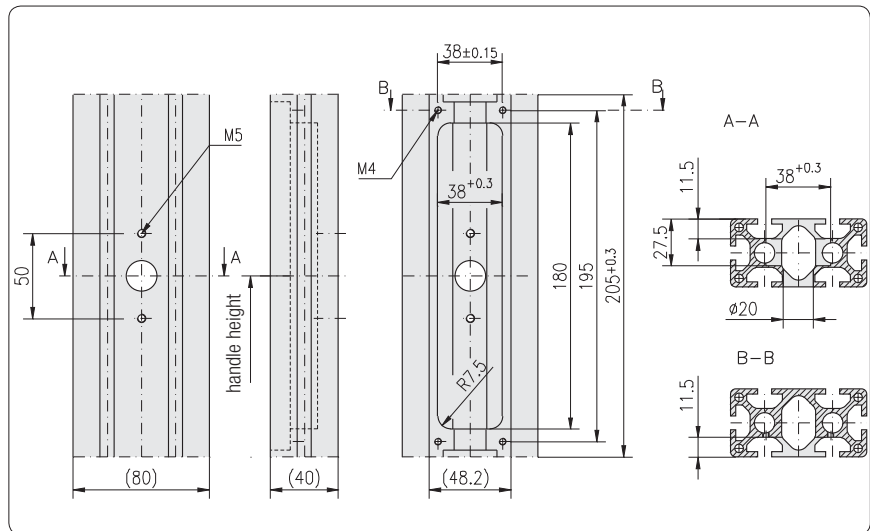
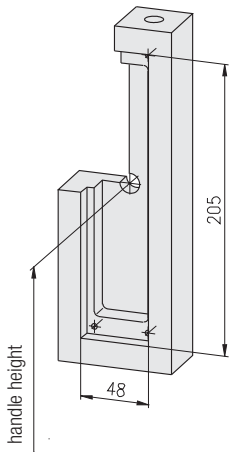

**Description**

Profile machining 40×80 for bar lock

**Article-No.**

1.65.5120

**Bar locks**

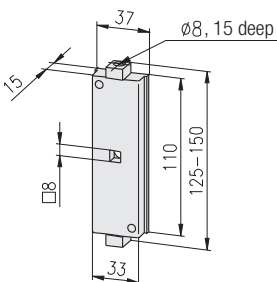

**Technical data**

material: steel  
surface: galvanised

**Description**

Bar lock, left side  
Bar lock, right side

**Weight**

230 g  
230 g

**Article-No.**

1.65.5210L  
1.65.5210R

Bar locks

Technical data

cover plate: alu, natural anodised  
 face plate: alu, natural anodised  
 bar: steel, galvanised  
 screws: steel, galvanised

Assembly accessories 30×60

for bar lock

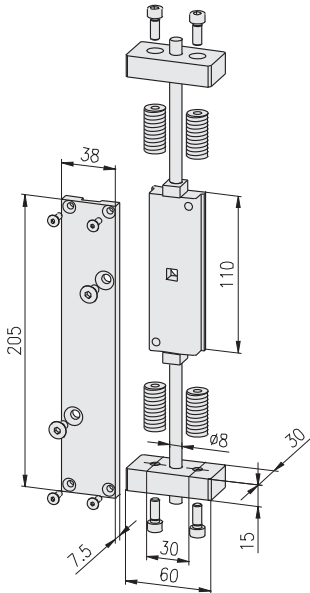

Description	Weight	Article-No.
Assembly accessories 30×60 for bar lock	590 g	1.65.5310

Single parts

Description	Pcs.	Weight	Article-No.
Cover plate 30×60	1	100 g	1.65.5311
Countersunk screw DIN 7991 - M4×12	4	1 g	0.63.D07991.04012
Countersunk screw DIN 7991 - M6×12	2	3 g	0.63.D07991.06012
Front plate 30×60	2	50 g	1.65.5312
Threaded insert M14/M6	4	22 g	1.35.1140615
Cap-screw DIN 912 - M6×16	4	5 g	0.63.D00912.06016
Bar, L1000	2	136 g	1.65.5313

Assembly accessories 40×80

for bar lock

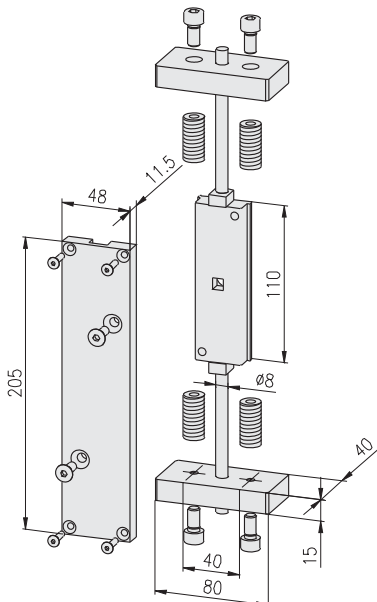

Description	Weight	Article-No.
Assembly accessories 40×80 for bar lock	800 g	1.65.5320

Single parts

Description	Pcs.	Weight	Article-No.
Cover plate 40×80	1	225 g	1.65.5321
Countersunk screw DIN 7991 - M4×16	4	2 g	0.63.D07991.04016
Countersunk screw DIN 7991 - M6×16	2	4 g	0.63.D07991.06016
Front plate 40×80	2	90 g	1.65.5322
Threaded insert M14/M8	4	18 g	1.35.1140815
Cap-screw DIN 912 - M8×16	4	9 g	0.63.D00912.08016
Bar, L1000	2	136 g	1.65.5313

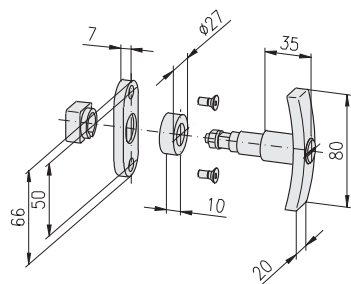
**Olive installation set**  
for bar lock

**Technical data**

material: GD-Zn, chrome-plated

**Comments**

Execution for profile 30×60 = with rosette

Execution for profile 40×80 = without rosette

Description	Weight	Article-No.
Olive installation set for bar lock without lock, for profile 30×60	166 g	1.65.5410
for profile 40×80	160 g	1.65.5420
Olive installation set for bar lock with lock, for profile 30×60	175 g	1.65.5510
for profile 40×80	169 g	1.65.5520

**Single parts**

Description	Pcs.	Weight	Article-No.
Olive without lock	1	122 g	1.65.5431
Olive with lock, incl. 2 keys	1	120 g	1.65.5531
Rosette	1	8 g	1.65.5432
Countersunk screw DIN 7991 - M5×12	2	2 g	0.63.D07991.05012

**Lock mounting set**
**Technical data**

lock insert: GD-Zn, galvanised

key: GD-Zn, galvanised

rosette: LM, natural anodised

key catch: PVC, grey

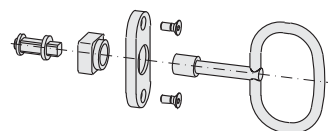
**with square key**  
for bar lock

Description	Weight	Article-No.
Lock mounting set with square key for bar lock	73 g	1.65.5600

**Single parts**

Description	Pcs.	Weight	Article-No.
Lock insert	1	16 g	1.65.5601
Key catch	1	3 g	1.65.5602
Rosette	1	8 g	1.65.5432
Square key 8 mm	1	42 g	1.65.34581
Countersunk screw DIN 7991 - M5×12	2	2 g	0.63.D07991.05012

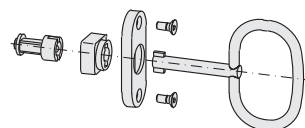
**with double beard key**  
for bar lock

Description	Weight	Article-No.
Lock mounting set with double beard key for bar lock	73 g	1.65.5700

**Single parts**

Description	Pcs.	Weight	Article-No.
Lock insert	1	16 g	1.65.5701
Key catch	1	3 g	1.65.5702
Rosette	1	8 g	1.65.5432
Double beard key Ø3	1	42 g	1.65.34789
Countersunk screw DIN 7991 - M5×12	2	2 g	0.63.D07991.05012

**Latch locks**

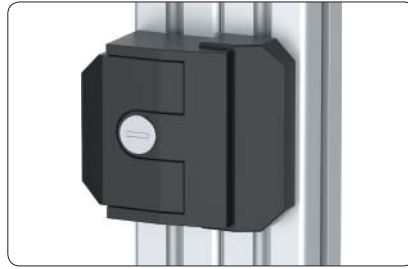

**Application**

Door lock with small jutout

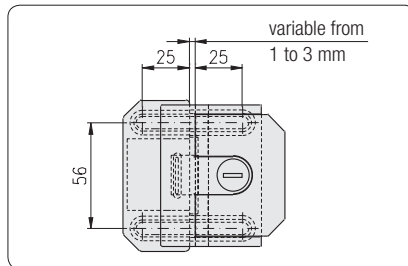

Installation dimensions

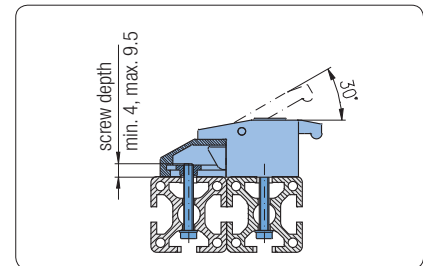

Installation dimensions

**Technical data**

- material:
- capsule: GDZn black coated
  - trap: GDZn rough
  - nut: steel galvanised

**Mounting elements**

- cap-screw DIN 6913, M6
- washer DIN 433-6.4

**Delivery unit**

- latch lock
- 4 nuts M6
- 2 keys (by variant with lock)
- cover plug (by variant without lock)

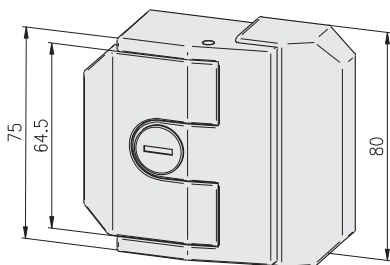

**Description**

Description	Weight	Article-No.
Latch lock without lock	560 g	1.65.6010
Latch lock with lock, all keyed alike	560 g	1.65.6020
Latch lock with lock, keyed different	560 g	1.65.6030

Roller 39



**Application**

Roller for guiding in the 8 mm profile slot for sliding doors

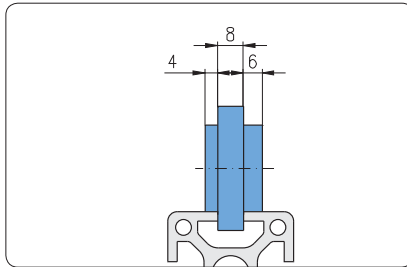

Asymmetric mount

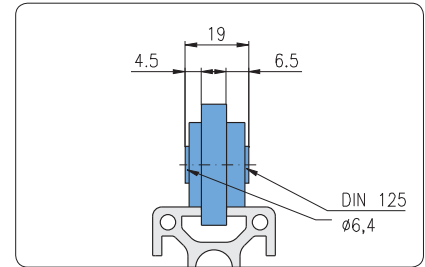

Mounting measure incl. washer DIN 125

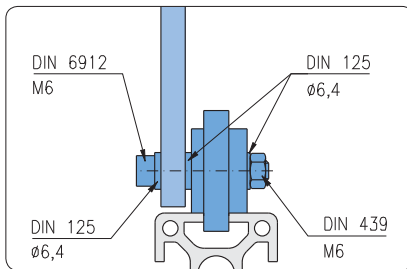

Mounting with threaded pillar

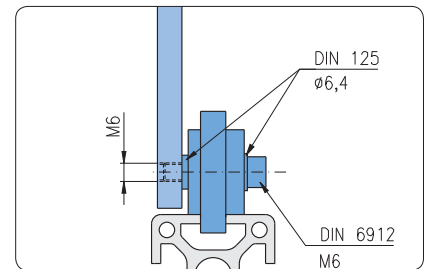

Mounting with thread in panel element

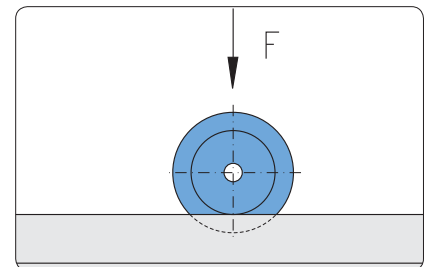

**Technical data**

material: PA-GF  
 colour: black  
 max. static load: F = 150 N

**Comments**

2 deep grooved ball bearings with 2 cover discs

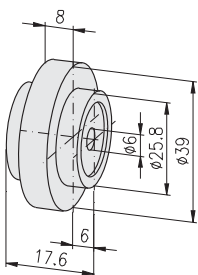

**Description**

Roller 39

**Weight**

32 g

**Article-No.**

1.66.1395



Roller fastening sets  
type A



Roller fastening set type A, one-sided

**Application**

The roller fastening set allows the mounting of the roller into the panel element. Thus the panel element fits in the slot and fills the frame completely



Roller fastening set type A, double-sided

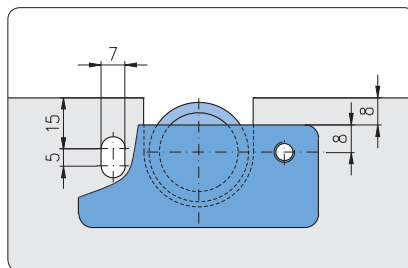

Mounting on top side

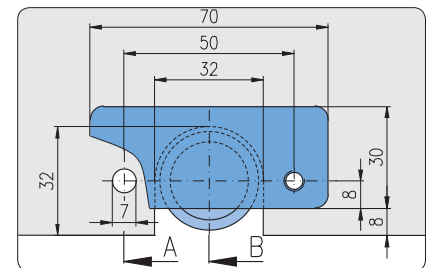

Mounting on bottom side

**Comments**

The elongated hole in the panel element allows the adjustment of the height tolerance

Roller fastening sets  
type A

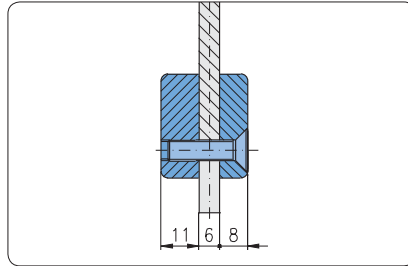

Panel element 6 mm  
View A - A

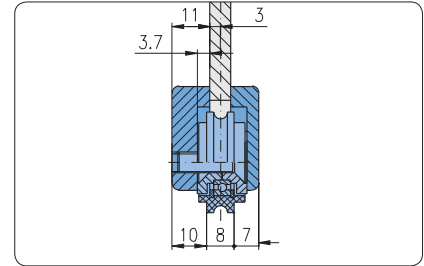

Panel element 6 mm  
View B - B

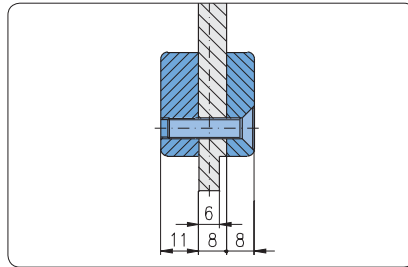

Panel element 8 mm  
View A - A

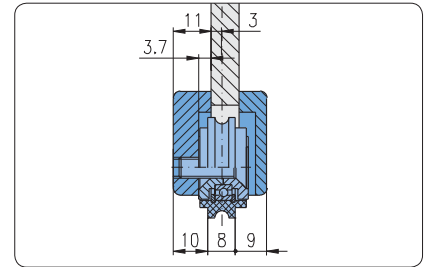

Panel element 8 mm  
View B - B

**Technical data**

base body  
material: aluminium  
surface: natural anodised

one sided

Description	Weight	Article-No.
Roller fastening set type A, one sided, complete	55.5 g	1.66.5160



**Single parts**

Description	Pcs.	Weight	Article-No.
Roller bracket type A, left	1	21.0 g	1.66.5299
Roller 29	1	12.0 g	1.66.2290
Countersunk screw DIN 7991 - M6×20	1	4.5 g	0.63.D07991.06020
Cap-screw DIN 6912 - M6×20	2	5.0 g	0.63.D06912.06020
Washer DIN 6340 - 6.4	2	4.0 g	0.62.D06340.06,4

double sided

Description	Weight	Article-No.
Roller fastening set type A, double sided, complete	64.5 g	1.66.5260



**Single parts**

Description	Pcs.	Weight	Article-No.
Roller bracket type A, right	1	16.0 g	1.66.5298
Roller bracket type A, left	1	21.0 g	1.66.5299
Roller 29	1	12.0 g	1.66.2290
Countersunk screw DIN 7991 - M6×20	1	4.5 g	0.63.D07991.06020
Countersunk screw DIN 7991 - M6×25	2	5.5 g	0.63.D07991.06025



Roller fastening sets  
type B



Guidance in profile slot

**Application**

The roller fastening set allows the mounting of the roller into the panel element

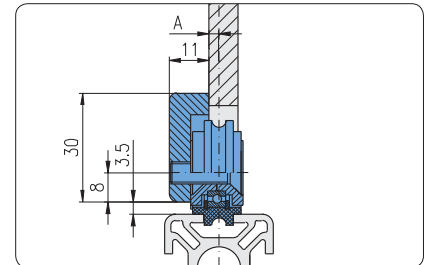

Guidance in twin track guide

**Comments**

Mounting position of roller optional

- A = 1.7 mm
- 2.7 mm

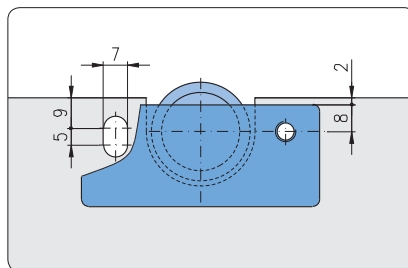

Mounting on top side

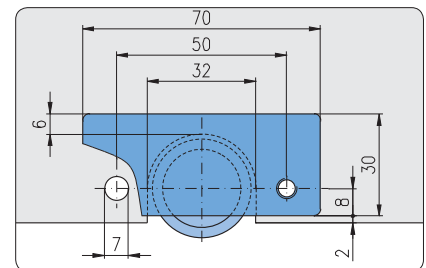

Mounting on bottom side

**Comments**

The elongated hole in the panel element allows to adjust the height tolerance and to unhinge the sliding door

**Roller fastening sets  
type B**



**Application**

Guidance of sliding door  
 on top: sliding profile 30x14  
 on bottom: twin track guide with profile

The slot in the panel element allows:

- adjustment of height tolerance
- removal of the sliding door

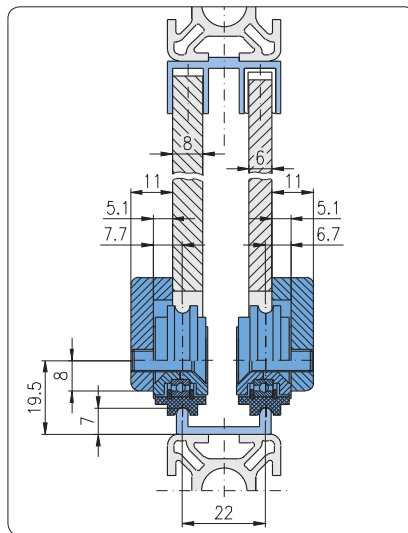

Mounting position of roller:  
 dimension 6.7 = panel element 6 mm  
 dimension 7.7 = panel element 8 mm

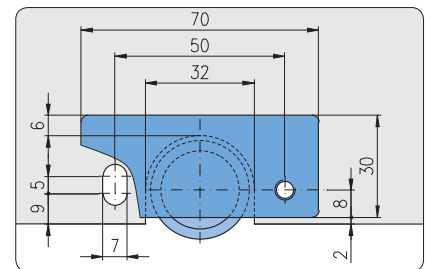

**Technical data**

base body  
 material: aluminium  
 surface: natural anodised

Description	Weight	Article-No.
Roller fastening set type B, complete	62 g	1.66.5360

**Single parts**



Description	Pcs.	Weight	Article-No.
Roller bracket type B	1	21.0 g	1.66.5399
Roller 29	1	12.0 g	1.66.2290
Countersunk screw DIN 7991 - M6x20	1	4.5 g	0.63.D07991.06020
Cap-screw DIN 6912 - M6x20	2	5.0 g	0.63.D06912.06020
Washer DIN 6340 - 6.4	2	4.0 g	0.62.D06340.06,4



Edge roller



**Application**

Roller conveyors for transporting boxes and containers

- low noise
- low friction operation due to double ball bearings
- simple assembly

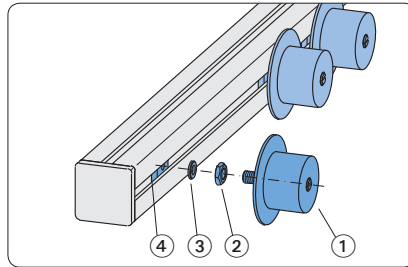

**Single parts**

- ① edge roller
- ② hexagon nut
- ③ shim
- ④ threaded plate

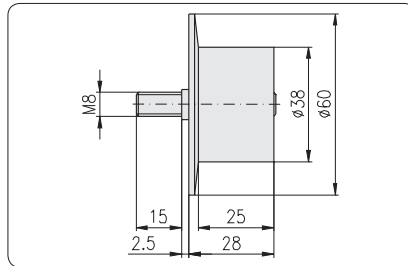

**Technical data**

material:

- roller: impact resistant plastic
- axle: galvanised

colour:

- roller: black

bearings: steel or stainlessball bearings  
on galvanised steel bolt

loading capacity:

- static: 50 N
- dynamic: 100 N

**Mounting elements**

threaded plate E M8	1.31.EM8
hexagon nut DIN 934 - M8	0.61.D00934.08
washer DIN 125 - 8.4	0.62.D00125.A08,4

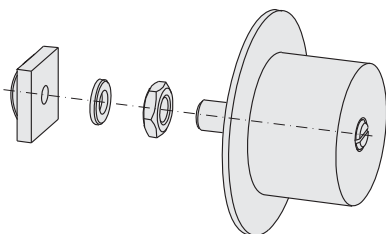

**Description**

Edge roller E

**Weight**

51.0 g

**Article-No.**

1.66.7523860

**Runner**  
for sliding suspended doors



**Application**

Sliding suspended doors made of profile frames for large openings and heavy doors

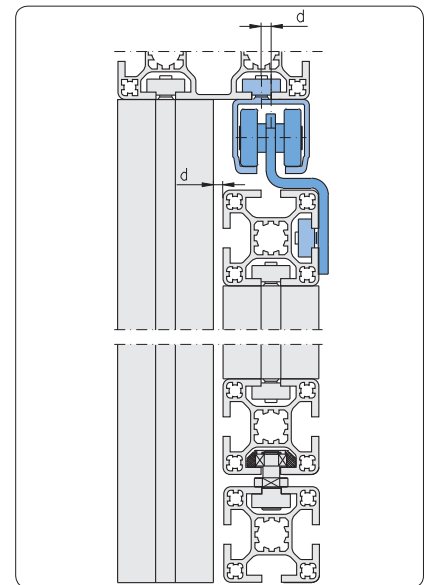
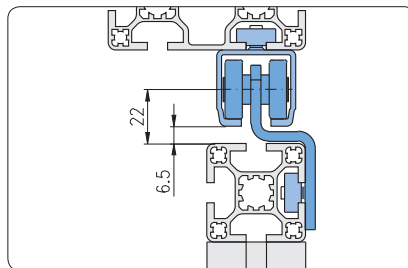

Distance d = mismatch of Alu C-track

**Alu C-track**  
for suspended doors

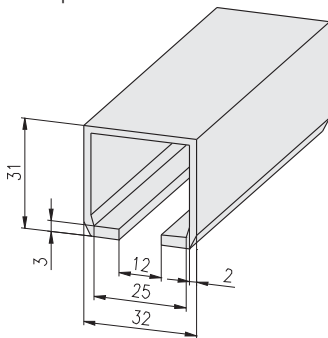

**Technical data**

bar length: 6 m  
material: aluminium  
surface: natural anodised

**Description**

Description	Weight	Article-No.
Alu C-track bar	3.6 kg	1.19.14532.60
Alu C-track cut to length	0.6 kg	1.19.14532-A00A00/... /... = length in mm

**Runner**  
for sliding suspended door

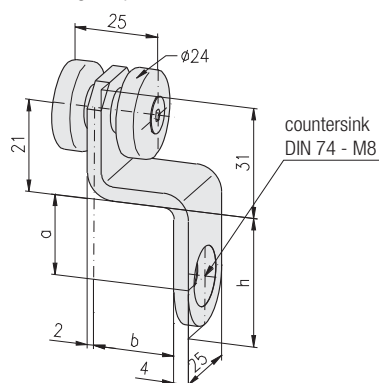

**Technical data**

material: VA  
• strap: VA  
• bolt: C45 K  
• distance bush: AlMg3  
max. load capacity: 100 kg

**Comments**

Countersink DIN 74 - M8 for countersunk screw DIN 7991 - M8

**Description**

Description	a	b	h	Weight	Article-No.
Runner for sliding susp. door, PG 40	21.0	20.0	38.0	102 g	1.66.81140
Runner for sliding susp. door, PG 45	23.5	22.5	43.0	114 g	1.66.81145

**Stopper Type 1**  
for sliding suspended door

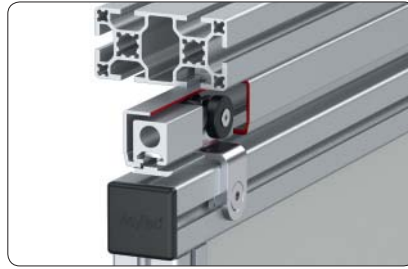
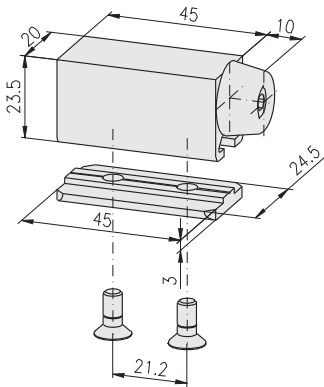

Description	Weight	Article-No.
Stopper Type 1 for sliding suspended door, complete	63 g	1.66.8201055

**Stopper Type 2**  
for sliding suspended door

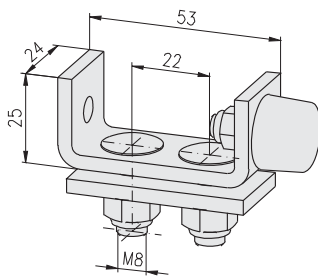

Description	Weight	Article-No.
Stopper Type 2 for sliding suspended door, complete	160 g	1.66.8202065

**Frame guide**  
for suspended door

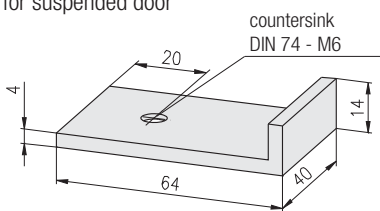

**Technical data**

material: aluminium  
surface: natural anodised

**Comments**

Countersink DIN 74 - M6 for countersunk screw DIN 7991 - M6

Description	Weight	Article-No.
Frame guide for suspended door	30 g	1.66.8050

**Rubber door stop**  
for suspended door

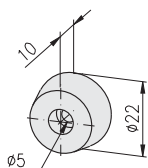

**Technical data**

material: rubber  
colour: black

Description	Weight	Article-No.
Rubber door stop for suspended door	3 g	1.66.8060

Slot rollers



**Application**

For light running sliding doors

**Technical data**

material: PETP  
 colour: black  
 max. static load: 8 kg/roller

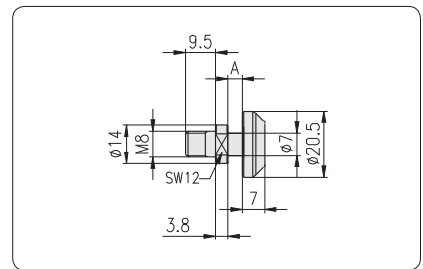
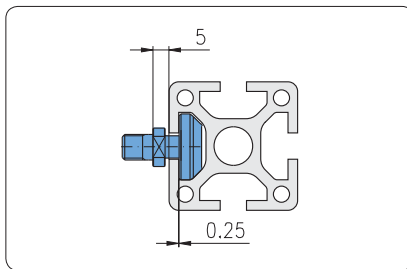
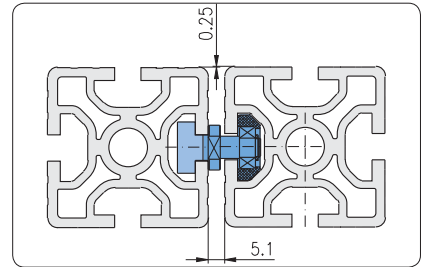
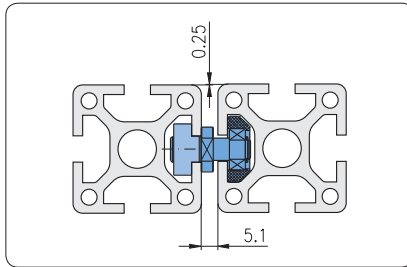

**Fastening elements (optional)**

- threaded plate E M8 1.31.EM8
- threaded plate, heavy, E M8 1.31.6EM8
- T-Nut, E M8 1.32.EM8
- T-Nut for subs. insertion E, M8 1.32.4EM8

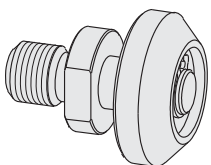

Description	A	Weight	Article-No.
Slot roller E3	4.45	24 g	1.67.42E3M8

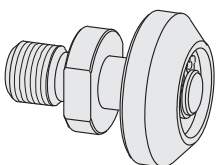

Description	A	Weight	Article-No.
Slot roller E4	5.45	24 g	1.67.42E4M8

Guidance system



**Application**

Slideway with sliding blocks e.g. for lifting tables and drawers

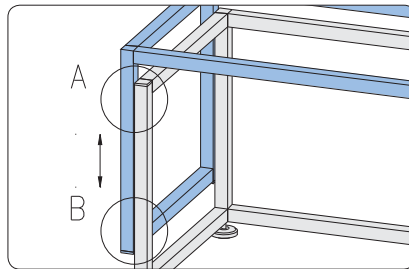

Slideway for lifting table

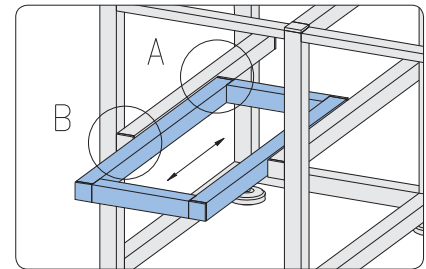

Slideway for drawer

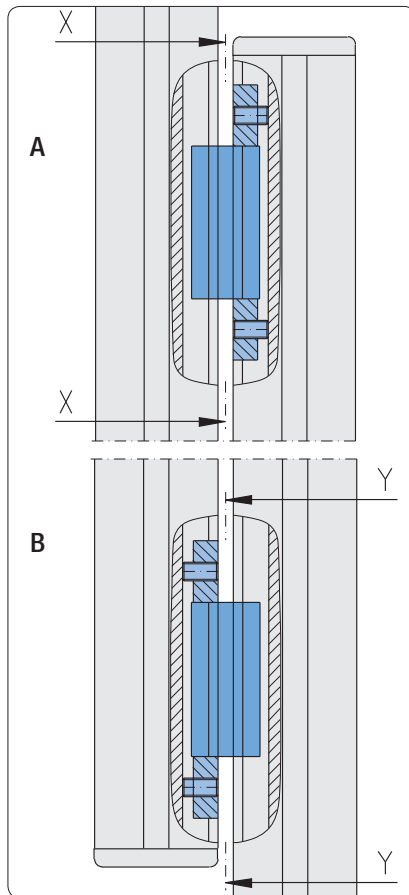

Details "A" and "B"

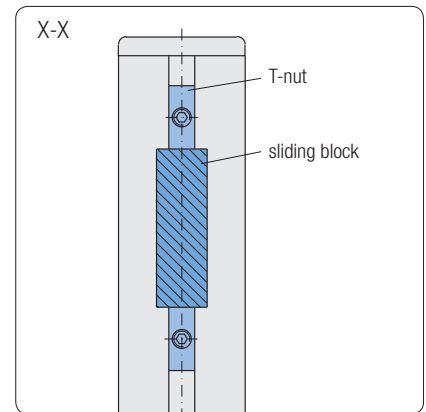

View "X"

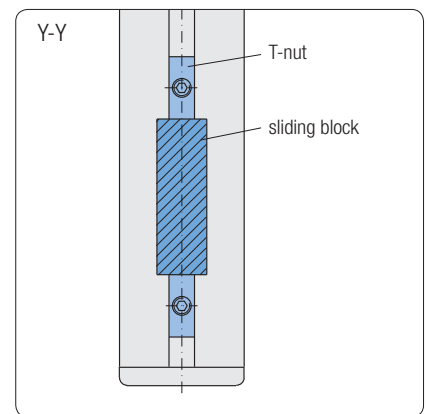

View "Y"

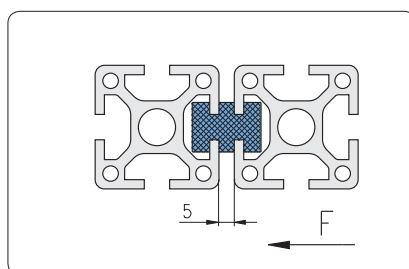



**Clamping**

for guidance system

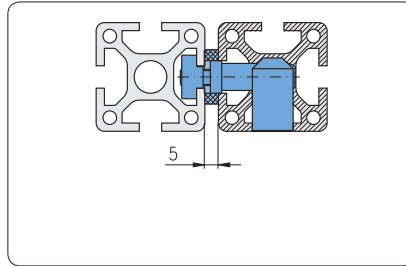

Clamping with setscrew

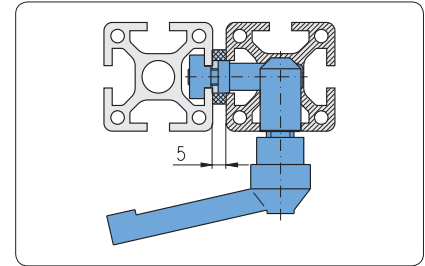

Clamping with clamping lever

**Single parts for clamping**

Description	Article-No.
T-nut sliding block	1.67.□M8
Distance washer	1.67.2008
Clamping lever	1.29.801030

**Connector**

Description	for profile	Article-No.
Connector, screw-type, parallel, M8	30×30	1.21.3/4S5M8/7
Connector, screw-type, parallel, M8	40×40	1.21.4/5S5M8/11
Connector, screw-type, parallel, M8	45×45	1.21.45/5S5M8/11
Connector, screw-type, parallel, M8	50×50	1.21.5/6S5M8/11
Connector, screw-type, parallel, M8	60×60	1.21.6S1M8/11

**Sliding blocks**

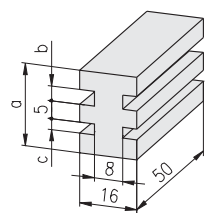
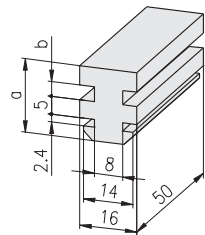
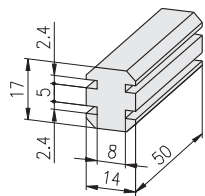

**Technical data**

material: PA6G oil,  
(murlubric or similar)  
colour: black  
max. carrying capacity:  $p = 20 \text{ N/mm}^2$   
at 

- temperature 20°C
- velocity 1 m/sec

**Comments**

raw finish on request

Description	F	Weight	Article-No.
Sliding block F	1,500 N	11 g	1.67.F2F2

Description	a	b	F	Weight	Article-No.
Sliding block F/E3	19.6	3.2	1,500 N	15 g	1.67.F2E3
Sliding block F/E4	20.6	4.2	1,500 N	15 g	1.67.F2E4

Description	a	b	c	F	Weight	Article-No.
Sliding block E3	22.2	3.2	3.2	2,000 N	18 g	1.67.E3E3
Sliding block E3/E4	23.2	3.2	4.2	2,000 N	18 g	1.67.E3E4
Sliding block E4	24.2	4.2	4.2	2,000 N	23 g	1.67.E4E4

**T-nut sliding blocks**

**Technical data**

material: PA6G oil (murlubric or similar)  
 colour: black

**Comments**

raw finish on request

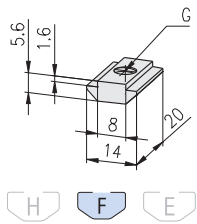

Description	G	Weight	Article-No.
T-nut sliding block F	M6	1.5 g	1.67.FM6
T-nut sliding block F	M8	1.5 g	1.67.FM8

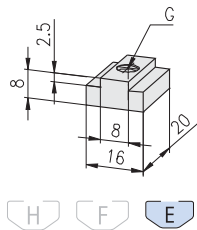

Description	G	Weight	Article-No.
T-nut sliding block E	M6	3.0 g	1.67.EM6
T-nut sliding block E	M8	3.0 g	1.67.EM8

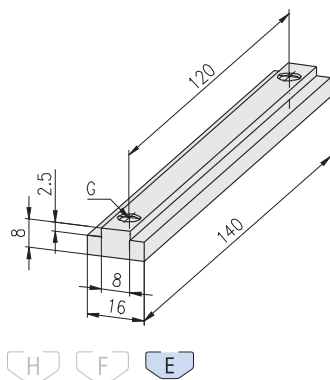

Description	G	Weight	Article-No.
T-nut sliding block E	2×M6	17.0 g	1.67.E2M61400
T-nut sliding block E	2×M8	16.6 g	1.67.E2M81400

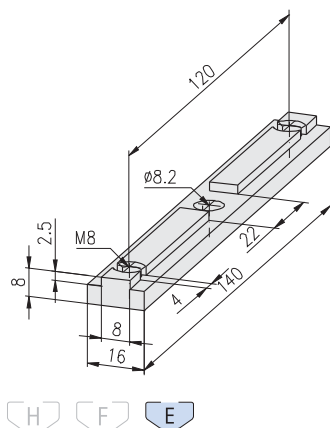

Description	Weight	Article-No.
T-nut sliding block E 2×M8 for Eco-Slide with clamping lever	15.6 g	1.67.E2M81408

**Distance washer**

**Technical data**

material: PVC  
 colour: grey

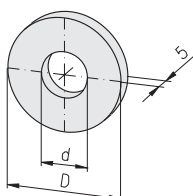

Description	D	d	Weight	Article-No.
Distance washer	22	8.3	3.0 g	1.67.2002
Distance washer	28	13.0	3.0 g	1.67.2008

Eco-Slides



**Application**

Sliding carriage in variable, simple and rugged design with low sliding resistance

High tolerance adjustment for width and height

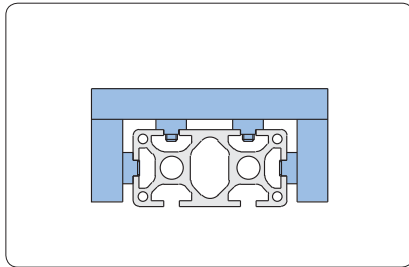

without clamping lever

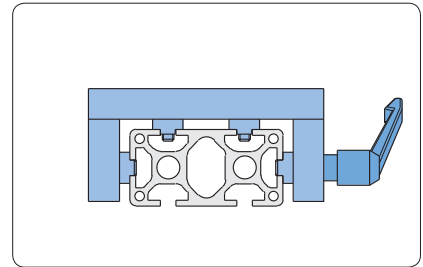

with clamping lever

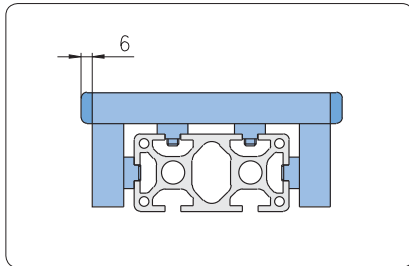

with side cover caps

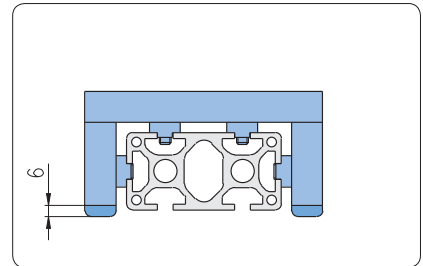

with lower cover caps

**Eco-Slide**  
for profile group 30  
F-slot

**Technical data**

loading capacity: max. 1,000 N

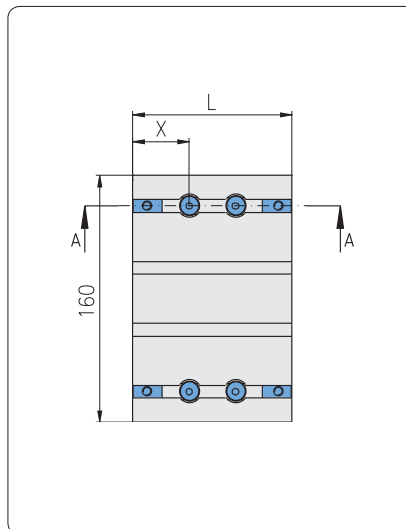
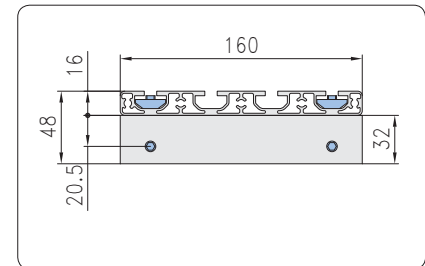
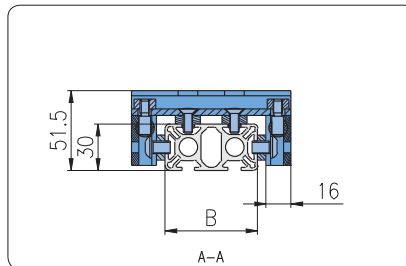
**Width of profile**
**30 mm**

Description	B	X	L	Weight	Article-No.
Eco-Slide, PG 30 - 30F		36,5	73	510 g	1.67.S101.030030F
Eco-Slide, PG 30 - 30F, with clamping lever		36,5	73	549 g	1.67.S102.030030F

**60 mm**

Description	B	X	L	Weight	Article-No.
Eco-Slide, PG 30 - 60F		36,5	103	600 g	1.67.S101.030060F
Eco-Slide, PG 30 - 60F, with clamping lever		36,5	103	639 g	1.67.S102.030060F

**100 mm**

Description	B	X	L	Weight	Article-No.
Eco-Slide, PG 30 - 100F		46,5	143	720 g	1.67.S101.030100F
Eco-Slide, PG 30 - 100F, with clamping lever		46,5	143	759 g	1.67.S102.030100F

**150 mm**

Description	B	X	L	Weight	Article-No.
Eco-Slide, PG 30 - 150F		46,5	193	810 g	1.67.S101.030150F
Eco-Slide, PG 30 - 150F, with clamping lever		46,5	193	849 g	1.67.S102.030150F

**Eco-Slide**  
for profile group 40  
E-slot



**Technical data**

loading capacity: max. 1,000 N

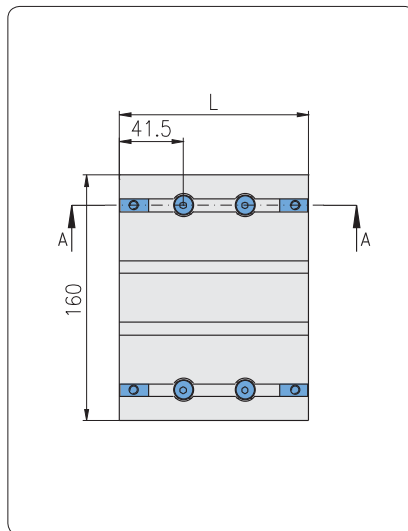
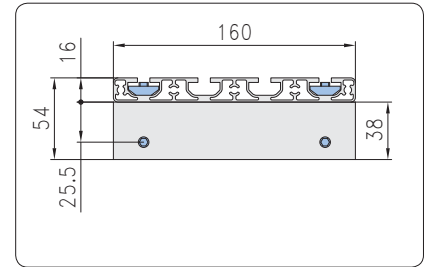
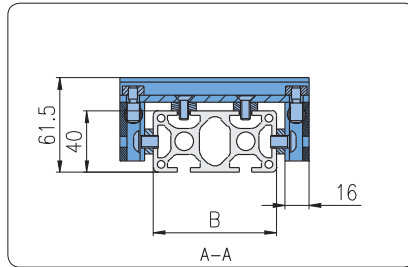

**Width of profile**

**40 mm**

Description	B	L	Weight	Article-No.
Eco-Slide, PG 40 - 40E		83	555 g	1.67.S101.040040E
Eco-Slide, PG 40 - 40E, with clamping lever		83	594 g	1.67.S102.040040E

**80 mm**

Description	B	L	Weight	Article-No.
Eco-Slide, PG 40 - 80E		123	670 g	1.67.S101.040080E
Eco-Slide, PG 40 - 80E, with clamping lever		123	709 g	1.67.S102.040080E

**120 mm**

Description	B	L	Weight	Article-No.
Eco-Slide, PG 40 - 120E		163	790 g	1.67.S101.040120E
Eco-Slide, PG 40 - 120E, with clamping lever		163	829 g	1.67.S102.040120E

**160 mm**

Description	B	L	Weight	Article-No.
Eco-Slide, PG 40 - 160E		203	910 g	1.67.S101.040160E
Eco-Slide, PG 40 - 160E, with clamping lever		203	949 g	1.67.S102.040160E

**Eco-Slide**  
for profile group 45  
E-slot



**Technical data**

loading capacity: max. 1,000 N

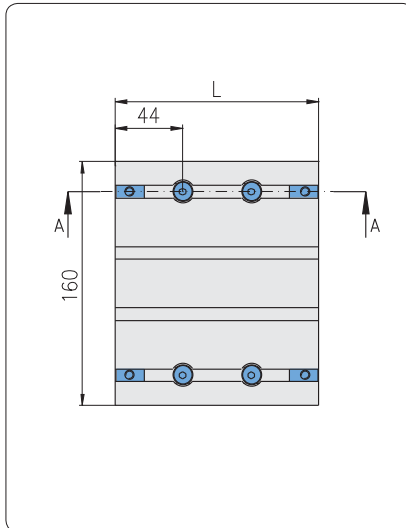
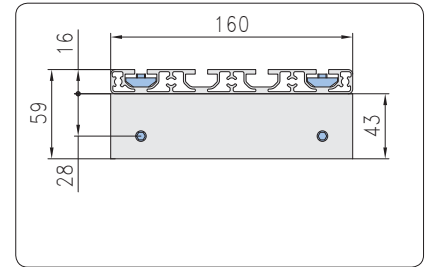
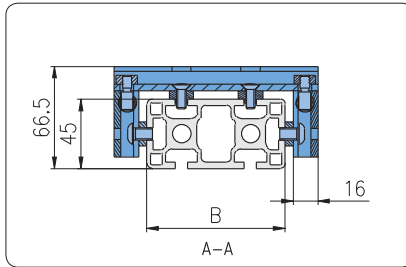

**Width of profile**

45 mm

Description	B	L	Weight	Article-No.
Eco-Slide, PG 45 - 45E	88	88	665 g	1.67.S101.045045E
Eco-Slide, PG 45 - 45E, with clamping lever	88	88	704 g	1.67.S102.045045E

90 mm

Description	B	L	Weight	Article-No.
Eco-Slide, PG 45 - 90E	133	133	710 g	1.67.S101.045090E
Eco-Slide, PG 45 - 90E, with clamping lever	133	133	749 g	1.67.S102.045090E

**Hanging bracket  
for safety barriers**



**Application**

Element for mounting un hingeable fence elements

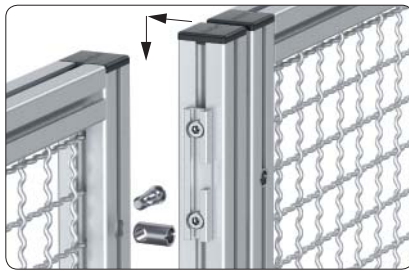

The connector cross bushing can be fixed at the front or back

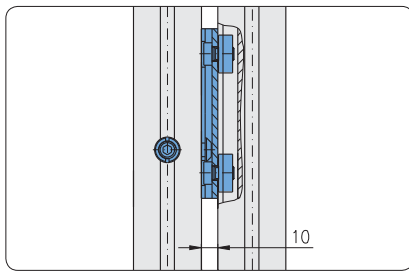

**Technical data**

material: aluminium  
strength: F25  
surface: natural anodised

**Comments**

- Elements needed for mounting:
- cap-screw DIN 6912 M8×12 with threaded plate
  - T-Nut for subsequent insertion M8 with cap-screw DIN 6912 M8×10
  - parallel-connector with F-head

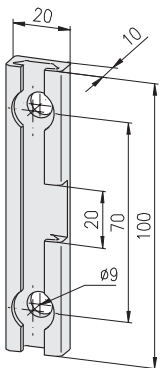

**Description**

Hanging bracket

**Weight**

16 g

**Article-No.**

1.68.201050

Suspended glider



**Application**

Element for tool suspension in MayTec-profile

**Technical data**

material: PA-GF  
 colour: black  
 max. static load: 300 N

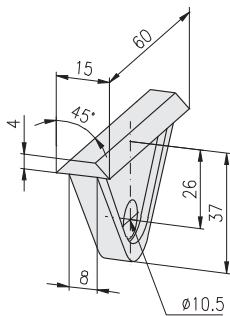

**Description**

Suspended glider F

**Weight**

10 g

**Article-No.**

1.69.F010

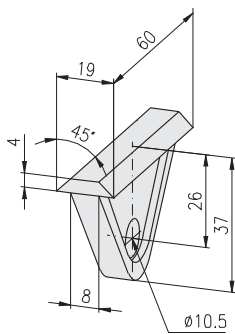

**Description**

Suspended glider E

**Weight**

10 g

**Article-No.**

1.69.E010

Carabine swivel

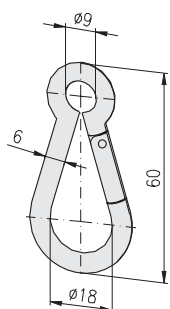

**Technical data**

material: steel  
 surface: galvanised

**Description**

Carabine swivel 60x6

**Weight**

27 g

**Article-No.**

1.69.1606



Potential equalisation



Application

Ground connections to establish the potential equalisation between two profiles  
 The serration at the bottom of the socket head of the connector pushes through the anodised coating of the profiles and thus provides the electrical contact

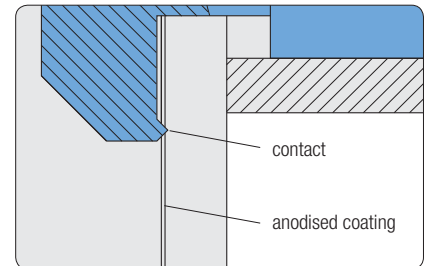
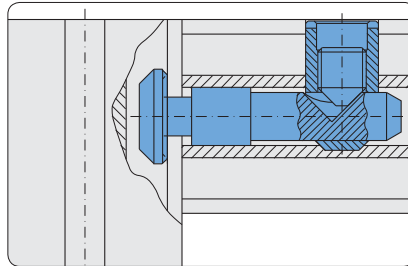

Comments

Suitable to equalise charge accumulations  
 Not suitable for higher currents

Technical data

Low current measurements in accordance with DIN VDE 0413, Part 4 for the control of protective circuits, earthing circuits and potential equalisation methods through low resistance connections for protection against dangerous currents

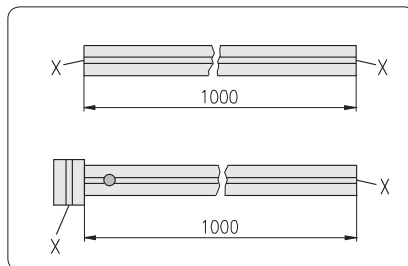

Resistance values with DC current of more than 200 mA with 1.0 m alu-profile	
without connector	0.11 Ω
with 1 standard connector	> 2 MΩ
with 1 univ. grounding connector	0.11 Ω

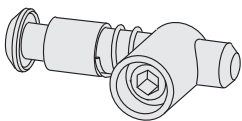

Description

Description	Article-No.
Connector, universal, grounding, PG 20	1.21.2FOE
Connector, universal, grounding, PG 30	1.21.3FOE
Connector, universal, grounding, PG 40	1.21.4FOE
Connector, universal, grounding, PG 45	1.21.45FOE
Connector, universal, grounding, PG 50	1.21.5FOE
Connector, universal, grounding, PG 60	1.21.6FOE

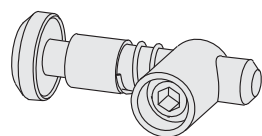

Description

Description	Article-No.
Connector, universal, grounding, PG 20	1.21.2EOE
Connector, universal, grounding, PG 30	1.21.3EOE
Connector, universal, grounding, PG 40	1.21.4EOE
Connector, universal, grounding, PG 45	1.21.45EOE
Connector, universal, grounding, PG 50	1.21.5EOE
Connector, universal, grounding, PG 60	1.21.6EOE

Comments

More grounding connectors  
 ↗ Connectors 1.2A

Ground connections



Application

Couplings for grounding of anodised profiles

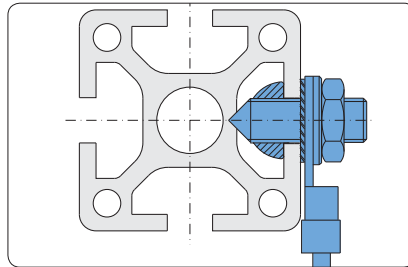

Comments

The grounding is caused by breaking the anodised layer at the bottom of the slot and at the profile's front side

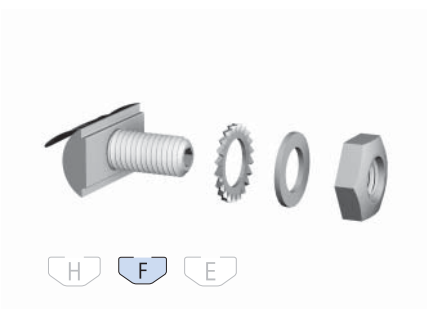

Description

Ground connection F, M6

Weight

74 g

Article-No.

1.70.10FM6

Single parts

T-Nut for subsequent insertion F, M6

Setscrew DIN 914 - M6×25 - V2A

Fan type lock washer DIN 6798 - A6.4 - V2A

Hexagon nut DIN 439 - M6 - Ms

Washer with chamfer DIN 125 - B6.4 - Ms

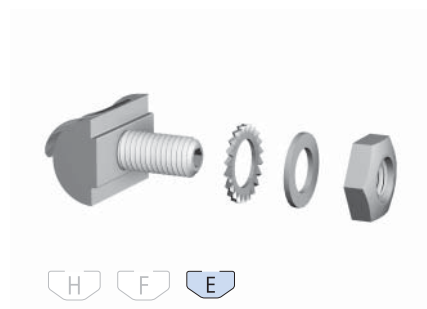

Description

Ground connection E, M8

Weight

146 g

Article-No.

1.70.10EM8

Single parts

T-Nut for subsequent insertion E, M8

Setscrew DIN 914 - M8×25 - V2A

Fan type lock washer DIN 6798 - A8.4 - V2A

Hexagon nut DIN 439 - M8 - Ms

Washer with chamfer DIN 125 - B8.4 - Ms

**Cable and hose clamp**

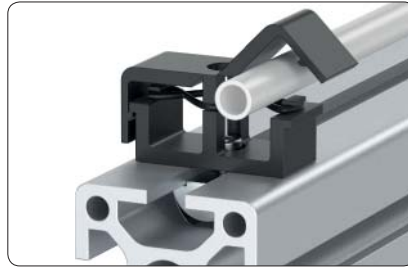

**Application**

Fixing element for cables and hoses up to  $\varnothing 12$  mm

**Technical data**

material: PA  
colour: black

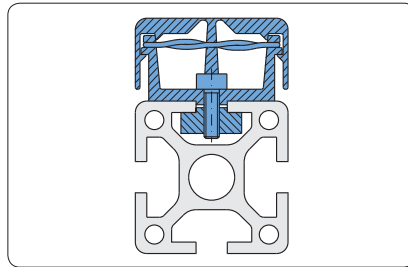

Mounting on profiles

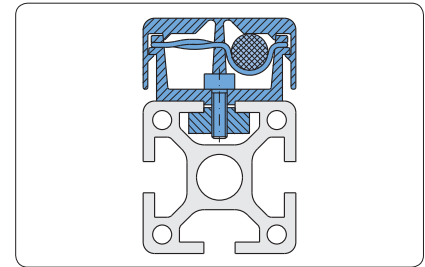

$\varnothing_{max} = 12$  mm for cables and hoses

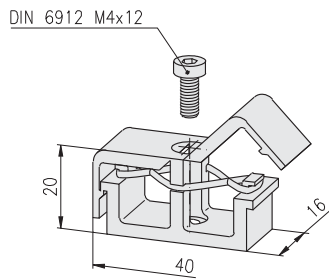

**Fastening elements for E-slot**

cap-screw DIN 6912 M4x12

T-Nut for subs. insertion, with leaf spring E, M4

spring-nut E, M4

T-slot nut E, M4

1.32.4EM4

1.33.EM4

1.34.10EM4

**Description**

Cable and hose clamp

**Weight**

8 g

**Article-No.**

1.71.1010

Block for cable binder,  
Cross-blocks for cable binder  
front-sided insertion,  
Cable binder

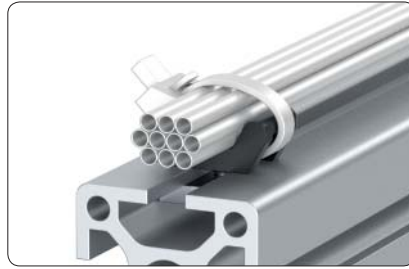

Block for cable binder

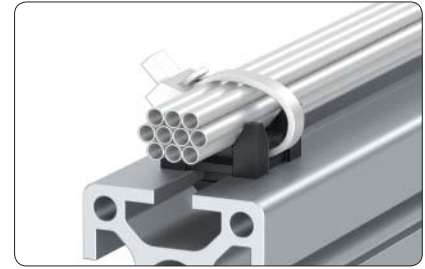

Cross-block for cable binder

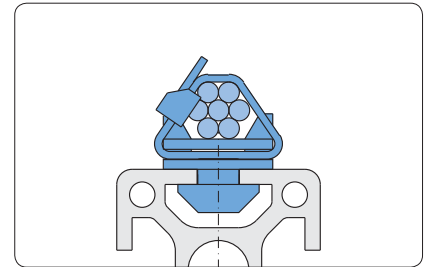
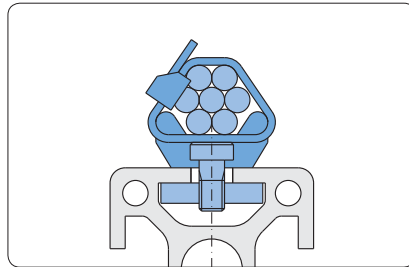

front-sided insertion

**Technical data**

material: PA  
colour: black

**Application**

Element for fixing single cables and hoses or large quantities

**Block for cable binder**

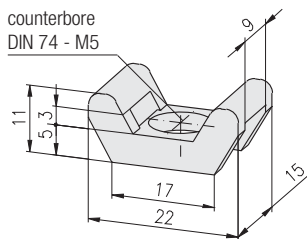

**Comments**

Counterbore DIN 74 - M5 for  
cap-screw DIN 6912 - M5

**Description**

Block for cable binder

**Weight**

1.6 g

**Article-No.**

1.71.2010

**Cross-blocks for cable binder**  
front-sided insertion

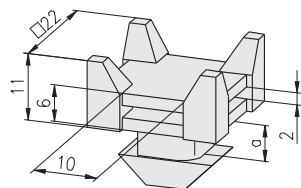

**Description**

Cross-block for cable binder F  
Cross-block for cable binder E3  
Cross-block for cable binder E4

**a**

2.2  
3.0  
4.0

**Weight**

4.0 g  
4.0 g  
4.0 g

**Article-No.**

1.71.2020F2  
1.71.2020E3  
1.71.2020E4

**Cable binder**  
detachable

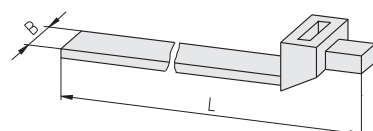

**Description**

Cable binder, detachable 4.8×190  
Cable binder, detachable 9.0×140

**B×L**

**Weight**

1.0 g  
1.9 g

**Article-No.**

1.71.2048190  
1.71.2090140

Installation rings



**Application**

Element for fixing large quantities of cables and hoses  
The rings can be opened for insertion

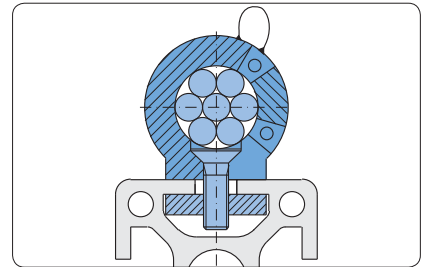

**Technical data**

material: PA-GF  
colour: black

**Comments**

Delivery unit incl. screw

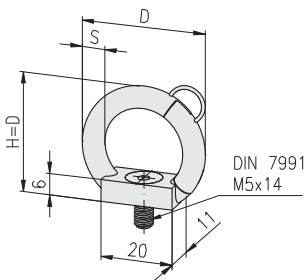

Description	D	s	Weight	Article-No.
Installation ring	Ø28.5	6.0	5 g	1.71.30285
Installation ring	Ø36.5	6.0	6 g	1.71.30365
Installation ring	Ø47.5	7.5	8 g	1.71.30475
Installation ring	Ø56.5	7.5	9 g	1.71.30565

Mounting set for 19" profile



Application

Fastening set for the assembly of 19" plug-in units and 19" profiles

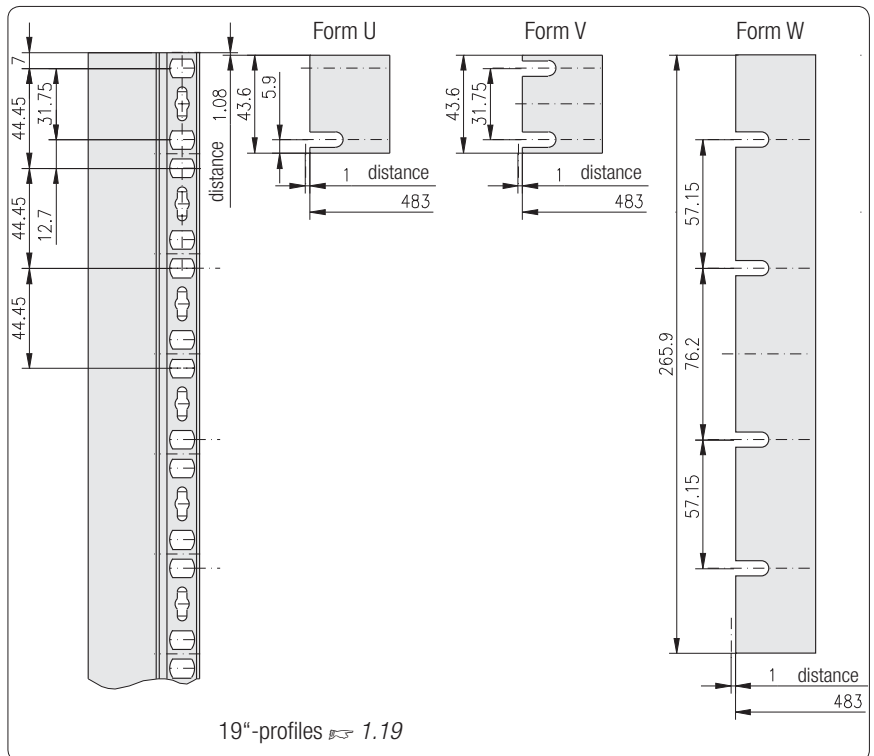
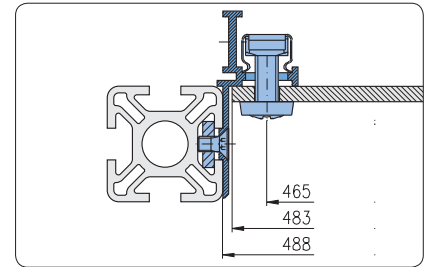

Dimensions for front panels and housings according to DIN 41494

Technical data

screw and nut: steel, galvanised  
 plate and socket washer: PA, black  
 delivery unit: PU with 10 mounting sets

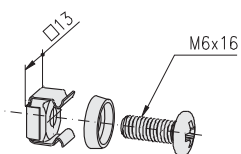

Description

Mounting set for 19" profile

Weight

70 g

Article-No.

1.72.2010.10

**Safety interlocking-mountings  
for swinging door**



**Application**

Mounting element for electrical interlocking switches

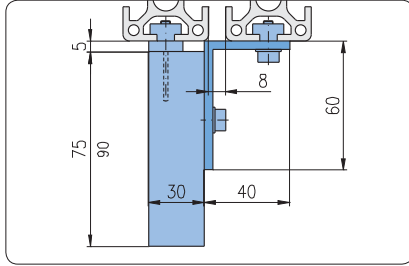

**Comments**

Assembly on  
profile 30×30  
profile 40×40  
profile 40×80

**Technical data**

material: aluminium  
surface: natural anodised

**for swinging door**

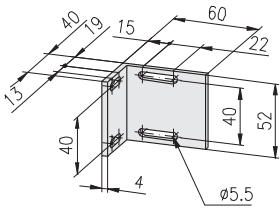

**Description**

Safety interlocking-mounting  
for swinging door

**Weight**

46 g

**Article-No.**

1.73.4010

**with lock for swinging door**

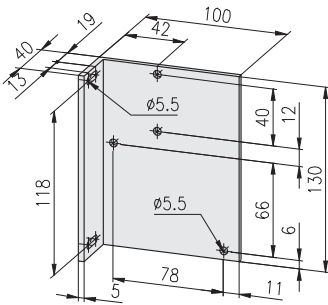

**Description**

Safety interlocking-mounting  
with lock for swinging door

**Weight**

183 g

**Article-No.**

1.73.4020

**Safety interlocking-mountings for sliding door**



**Application**

Mounting element for the electrical interlocking of sliding doors

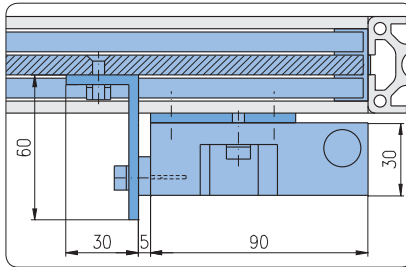

**Comments**

Assembly on profile 30×30  
profile 40×40  
profile 40×80

**Technical data**

material: aluminium  
surface: natural anodised

**Contact bracket-mounting for sliding door**

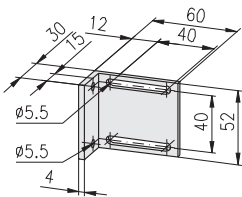

**Description**

Contact bracket-mounting for sliding door

**Weight**

41 g

**Article-No.**

1.73.4030

**Safety interlocking-mounting for sliding door**

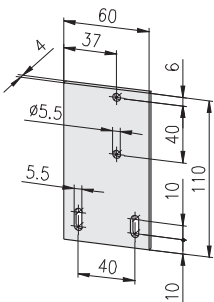

**Description**

Safety interlocking-mounting for sliding door

**Weight**

70 g

**Article-No.**

1.73.4040



**Safety interlocking-mountings  
AZ 17  
for swinging door**



**Application**

- Fastening elements for:
- safety switches AZ 17
  - safety closing AZM 170 at sliding doors

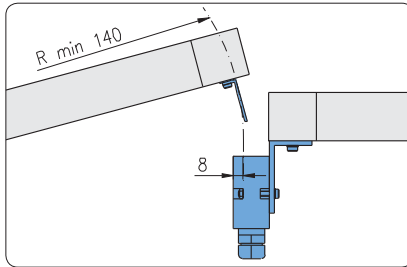

Activation key  
Mounting vertical to swivel radius

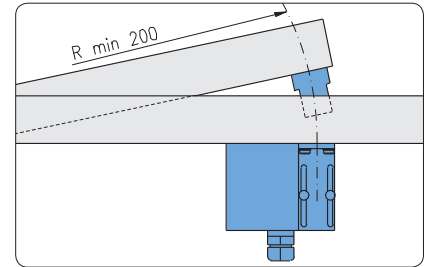

Activation key  
Mounting horizontal to swivel radius

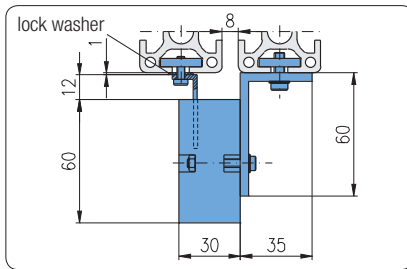

**Comments**

Assembly on  
profile 30×30  
profile 40×40  
profile 40×80

**Technical data**

material: aluminium  
surface: natural anodised

**Delivery**

Incl. lock washers DIN 9021 Ø4.3 mm  
for mounting activation key

**Description**

Safety interlocking-mounting AZ 17  
for swinging door

**Weight**

26 g

**Article-No.**

1.73.4110

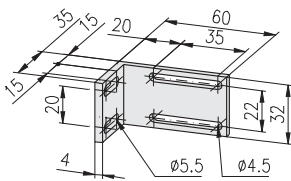

**Safety interlocking-mountings  
AZ 17  
for sliding door**



**Application**

- Fastening elements for:
- safety switches AZ 17
  - safety closing AZM 170 at sliding doors

**Mounting position:**  
Safety switch parallel to sliding door

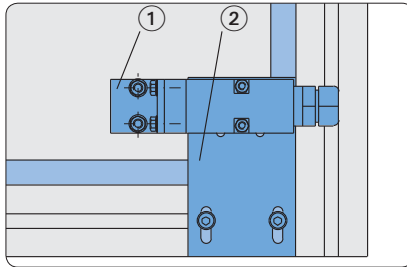

Fastening plate horizontal

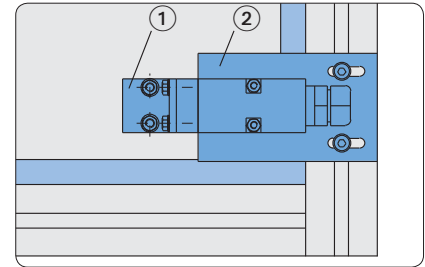

Fastening plate vertical

- ① Contact bracket-mounting AZ 17
- ② Safety interlocking-mounting AZ 17

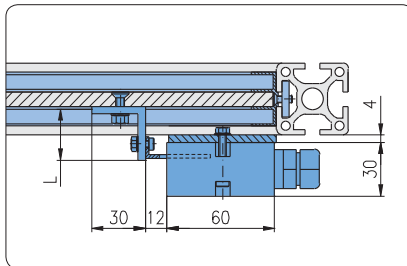

**Mounting position:**  
Safety switch across to sliding door

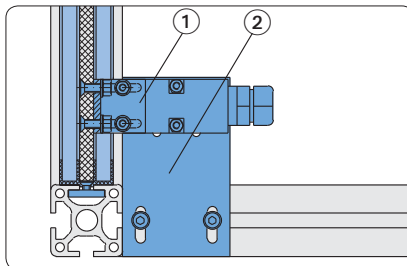

Fixing at cross profile

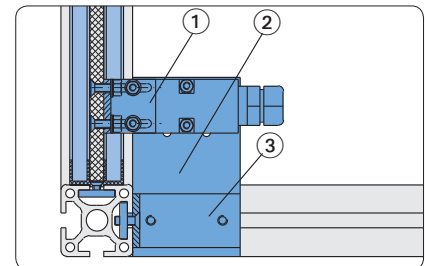

Fixing at longitudinal profile

- ① Contact bracket-mounting AZ 17
- ② Safety interlocking-mounting AZ 17
- ③ Angle for safety interlocking-mounting AZ 17

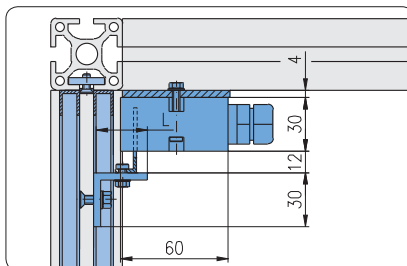

### Safety interlocking-mountings AZ 17 for sliding door

#### Technical data

material: aluminium  
surface: natural anodised

#### Comments

Assembly on  
profile 30×30  
profile 40×40  
profile 40×80

### Contact bracket-mounting AZ 17 for sliding door

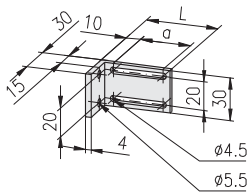

#### Description

Description	a	Weight	Article-No.
Contact bracket-mounting AZ 17 for sliding door, L 30	15	16 g	1.73.4123
Contact bracket-mounting AZ 17 for sliding door, L 40	25	19 g	1.73.4124
Contact bracket-mounting AZ 17 for sliding door, L 50	35	21 g	1.73.4125

### Safety interlocking-mounting AZ 17 for sliding door

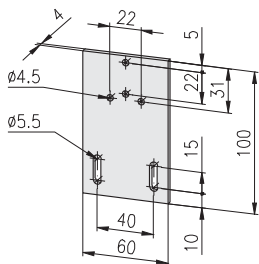

#### Description

Description	Weight	Article-No.
Safety interlocking-mounting AZ 17 for sliding door	62 g	1.73.4130

### Angle for safety interlocking-mounting AZ 17 for sliding door

#### Comments

Countersink DIN 74 - M5 for  
countersunk screw DIN 7991 - M5

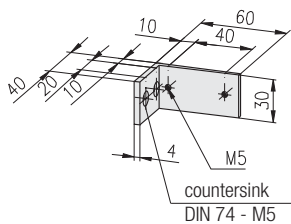

#### Description

Description	Weight	Article-No.
Angle for safety interlocking-mounting AZ 17 for sliding door	30 g	1.73.4140

Sensor brackets



**Application**  
For fastening of sensors



**Assembly**  
The toothed lock washer is fixed in profile slot and guarantees a reliable positioning

**Technical data**

material: PA, black

**Fastening elements**

cap-screw DIN 6912, M4

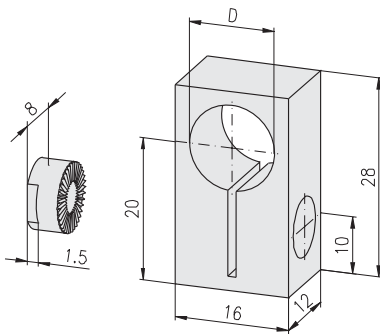

Description	D	Weight	Article-No.
Sensor bracket 8	Ø6.5	5.5 g	1.73.80806
Sensor bracket 8	Ø8	5.4 g	1.73.80808
Sensor bracket 8	Ø12	4.6 g	1.73.80812

Electrical installation trunking



Application

Installation trunking for electrical and pneumatic lines

Technical data

material: aluminium  
surface: natural anodised

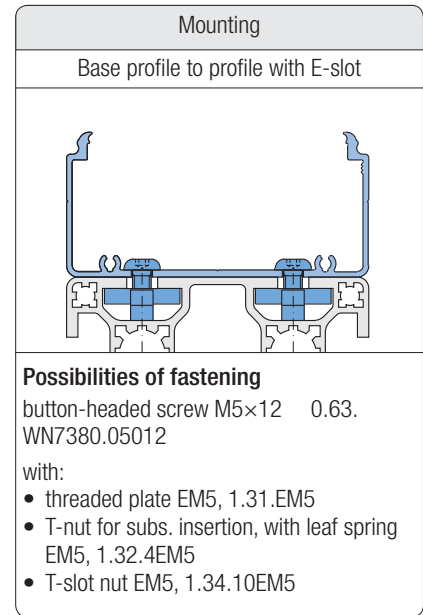
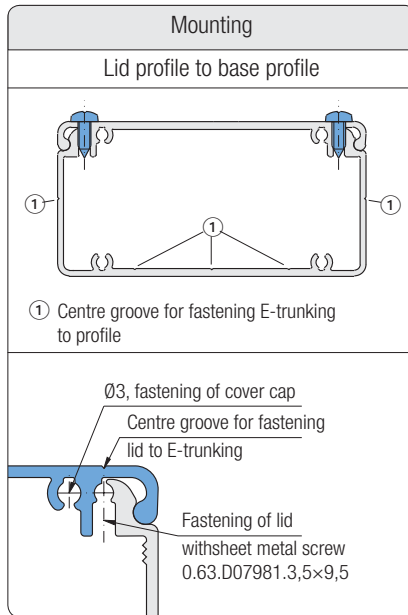

E-trunking

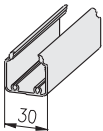

Description	Weight	Article-No.
E-trunking 30x30, bar 6 m	2.28 kg	1.19.203030G.60
E-trunking 30x30, cut to length	0.38 kg/m	1.19.203030G-A00A00/... /... = length in mm

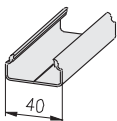

Description	Weight	Article-No.
E-trunking 40x20, bar 6 m	1.80 kg	1.19.204020G.60
E-trunking 40x20, cut to length	0.30 kg/m	1.19.204020G-A00A00/... /... = length in mm

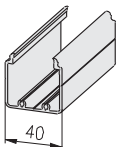

Description	Weight	Article-No.
E-trunking 40x40, bar 6 m	3.66 kg	1.19.204040G.60
E-trunking 40x40, cut to length	0.61 kg/m	1.19.204040G-A00A00/... /... = length in mm

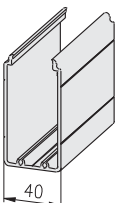

Description	Weight	Article-No.
E-trunking 40x80, bar 6 m	7.20 kg	1.19.204080G.60
E-trunking 40x80, cut to length	1.20 kg/m	1.19.204080G-F00F00/... /... = length in mm

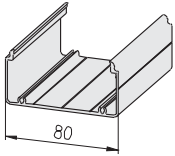

Description	Weight	Article-No.
E-trunking 80×40, bar 6 m	5.10 kg	1.19.208040G.60
 E-trunking 80×40, cut to length	0.85 kg/m	1.19.208040G-F00F00/... /... = length in mm

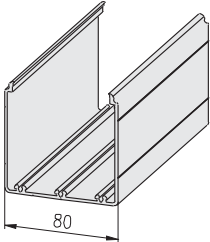

Description	Weight	Article-No.
E-trunking 80×80, bar 6 m	9.30 kg	1.19.208080G.60
 E-trunking 80×80, cut to length	1.55 kg/m	1.19.208080G-F00F00/... /... = length in mm

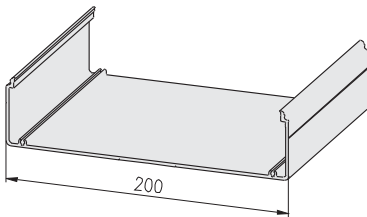

Description	Weight	Article-No.
E-trunking 200×50, bar 6 m	12.00 kg	1.19.220050G.60
 E-trunking 200×50, cut to length	2.0 kg/m	1.19.220050G-L00L00/... /... = length in mm

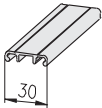
**E-trunking, lids**

Description	Weight	Article-No.
E-trunking, lid 30, bar 6 m	1.44 kg	1.19.2030D.60
 E-trunking, lid 30, cut to length	0.24 kg/m	1.19.2030D-A00A00/... /... = length in mm

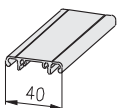

Description	Weight	Article-No.
E-trunking, lid 40, bar 6 m	2.10 kg	1.19.2040D.60
 E-trunking, lid 40, cut to length	0.35 kg/m	1.19.2040D-A00A00/... /... = length in mm

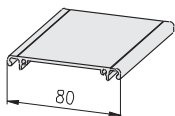

Description	Weight	Article-No.
E-trunking, lid 80, bar 6 m	3.54 kg	1.19.2080D.60
 E-trunking, lid 80, cut to length	0.59 kg/m	1.19.2080D-F00F00/... /... = length in mm

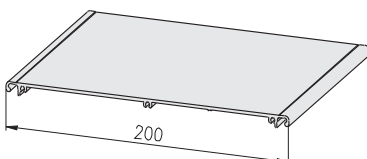

Description	Weight	Article-No.
E-trunking, lid 200, bar 6 m	9.00 kg	1.19.2200D.60
 E-trunking, lid 200, cut to length	1.50 kg/m	1.19.2200D-L00L00/... /... = length in mm

**E-trunking**

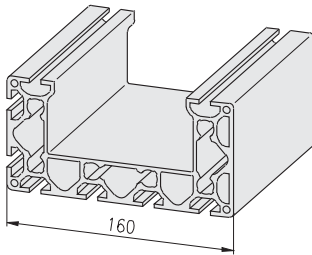

Description	Weight	Article-No.
Profile 80×160, 8E, SP, bar 6 m	47.40 kg	1.11.080160.89SP.60
 Profile 80×160, 8E, SP, cut to length	7.90 kg/m	1.11.080160.89SP-L00L00/... /... = length in mm

**E-trunking, lid**

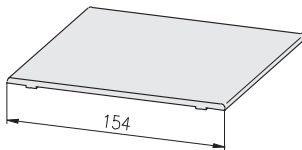

Description	Weight	Article-No.
Profile pre-cut lid 120, bar 6 m	10.80 kg	1.19.1101120.60
 Profile pre-cut lid 120, cut to length	1.80 kg/m	1.19.1101120-L00L00/... /... = length in mm

**E-trunking, end plates**

**Technical data**

material: stainless steel  
surface: pickled and passivated

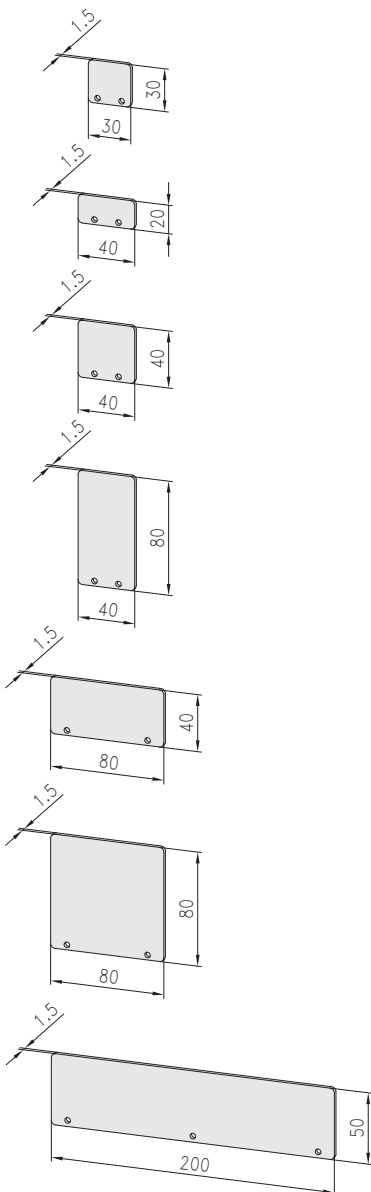

Description	Weight	Article-No.
E-trunking, end plate 30×30	3.8 g	1.75.2030302

Description	Weight	Article-No.
E-trunking, end plate 40×20	3.8 g	1.75.2040202

Description	Weight	Article-No.
E-trunking, end plate 40×40	6.8 g	1.75.2040402

Description	Weight	Article-No.
E-trunking, end plate 40×80	13.8 g	1.75.2040802

Description	Weight	Article-No.
E-trunking, end plate 80×40	13.8 g	1.75.2080402

Description	Weight	Article-No.
E-trunking, end plate 80×80	27.7 g	1.75.2080802

Description	Weight	Article-No.
E-trunking, end plate 200×50	43.3 g	1.75.2200503

**Electrical installation trunking for clips**

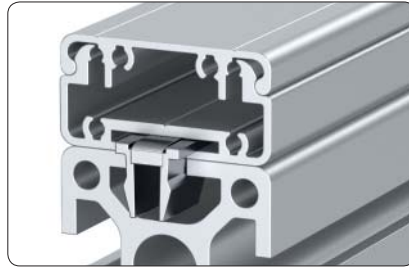

**Application**

Clip-system for quick assembly of the E-trunking

**Technical data**

material: aluminium  
surface: natural anodised

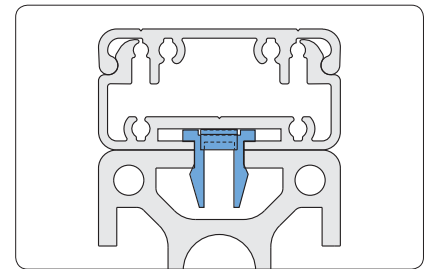
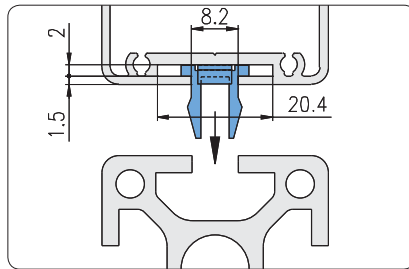

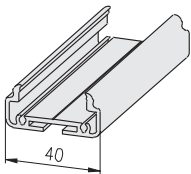

**E-trunking, for clips**

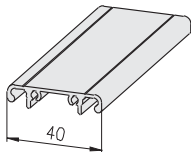

Description	Weight	Article-No.
E-trunking 40×20, Clips, bar 6 m	3.00 kg	1.19.214020G.60
 E-trunking 40×20, Clips, cut to length	0.50 kg/m	1.19.214020G-A00A00/... /... = length in mm

**E-trunking, lid**



Description	Weight	Article-No.
E-trunking, lid 40, bar 6 m	2.10 kg	1.19.2040D.60
 E-trunking, lid 40, cut to length	0.35 kg/m	1.19.2040D-A00A00/... /... = length in mm

**E-trunking, end plate**

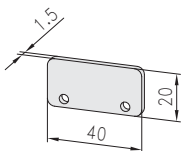

**Technical data**

material: stainless steel  
surface: pickled and passivated

Description	Weight	Article-No.
E-trunking, end plate 40×20, Clips	3.8 g	1.75.2140202

**Clip for E-trunking**

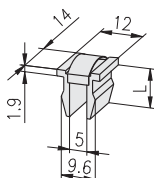

**Technical data**

material: Murytal C  
colour: natural

Description	L	Weight	Article-No.
Clip E3	11	3.0 g	1.75.1000E3
Clip E4	12	3.0 g	1.75.1000E4





**Corner element 33  
for wire net mounting profile 33×10**

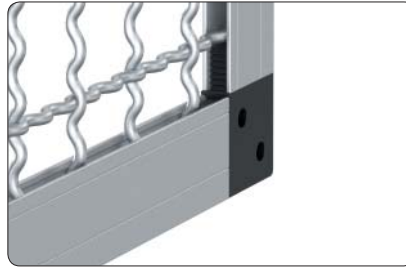

**Application**

This profile allows simple and safe installation of wire nets

**Comments**

Wire net mounting profile 33×10  
[➤ 1.19.1423...](#)

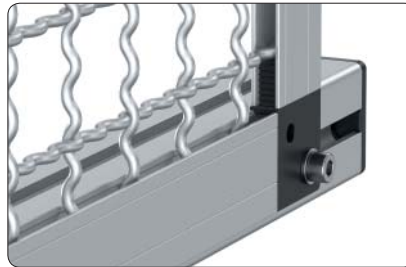

Outside mounting

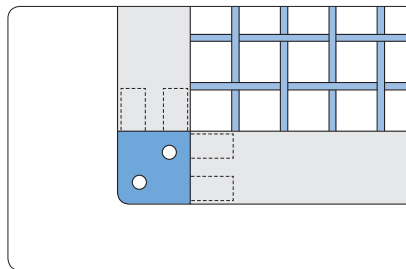

Outside corner

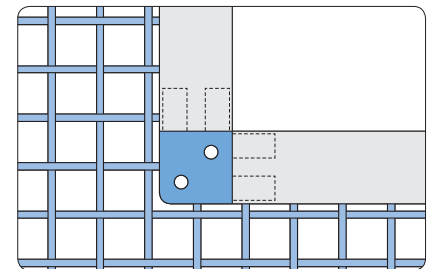

Inside corner

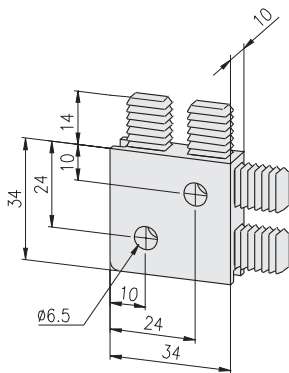

**Technical data**

material: PA - GF  
 colour: black

Description	Weight	Article-No.
Corner element 33	16 g	1.81.23310

Mounting sockets

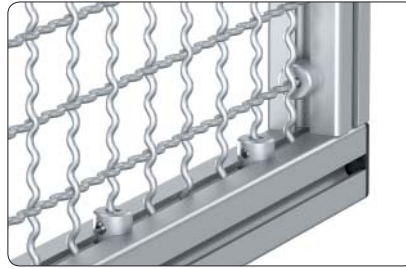

Application

For stable and vibration free fastening of wire nets

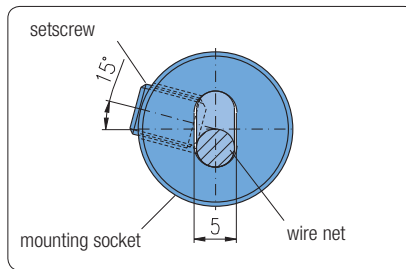
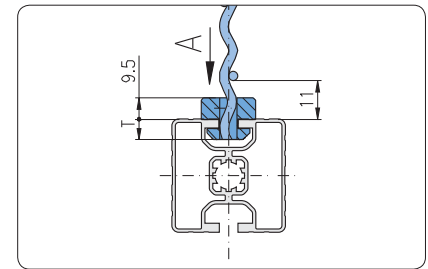
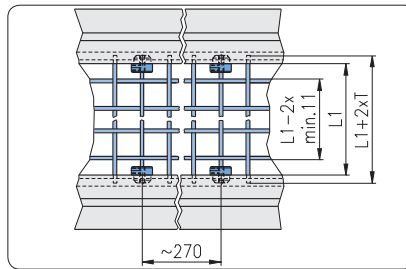

Assembly

- plug terminal sockets at a distance of about 270 mm on the wire net
- push on profile
- rotate mounting sockets with headless setscrew DIN 913 M6×8 at an angle of 15°

View „A“

Technical data

material:  
 mounting socket: aluminium, natural anodised  
 setscrew: steel, galvanised

Delivery unit

Mounting socket incl. setscrew

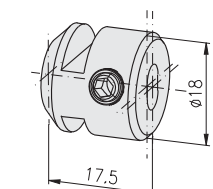
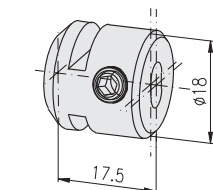
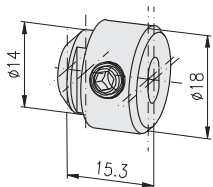

Description	T	Weight	Article-No.
Mounting socket, F	5	6 g	1.81.510F

Description	T	Weight	Article-No.
Mounting socket, E3	8	6 g	1.81.510E3

Description	T	Weight	Article-No.
Mounting socket, E4	8	6 g	1.81.510E4

Panel elements

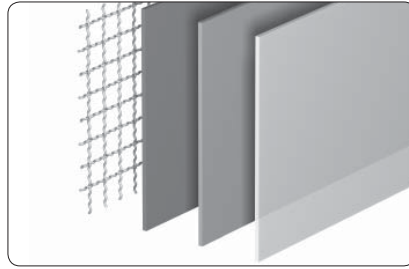

**Application**

Panel elements to cover machine frames, work stations, partition walls.



Panel element, fixing directly in the slot

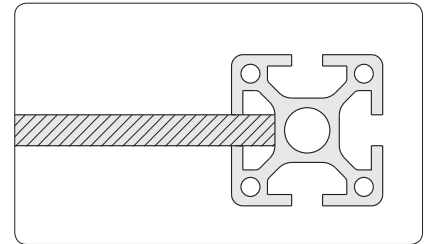

Installation accessories ↗ 1.41



Panel elements close to the outer contour by subsequent slitting of the profiles

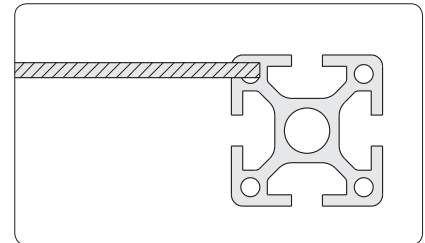

Special slits ↗ 1.1E.01



Panel elements close to the outer contour by applying panel profiles

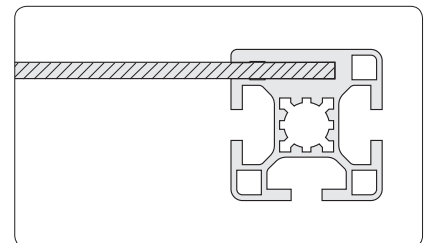

Panel profiles ↗ 1.14



Panel elements close to the outer contour by applying wire net profiles

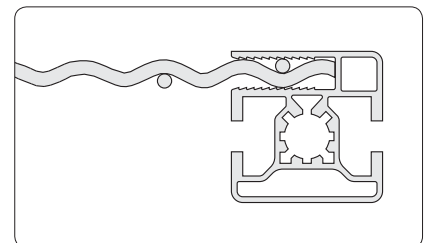

Wire net profiles ↗ 1.15



Panel elements close to the outer contour by fixing with angle or mounting block

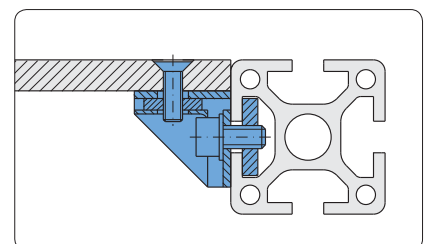

Mounting blocks ↗ 1.64

**Chipboards**  
**both sides coated with melamine**

Technical data	
surface:	both sides coated with melamine
structure:	mini pearl
RAL 7035:	light grey
formaldehydmission:	complies to safety standards §9 paragraph 3
light-fastness:	point 6 as per DIN 53799
temperature resistance:	- 25°C to 130°C
chemical resistance:	resistant against organic food, light acid contents and alkaline solution, gasoline, oil, tested as per DIN 53799
chipboard:	high frequency glued laminated chipboard
Technical values on DIN 68765 and 53799	
bulk density:	approx. 700 kg/m <sup>3</sup>
thickness tolerance:	+0.5 -0.3 mm
weight:	S = 8 mm    5.6 kg/m <sup>2</sup> S = 16 mm    11.2 kg/m <sup>2</sup> S = 19 mm    13.3 kg/m <sup>2</sup>
cut to length:	1.82.□□□-99/□□□□×□□□□    type 1.82.□□□-99/□□□□×□□□□    length×width in mm 1.82.□□□-99/□□□□×□□□□

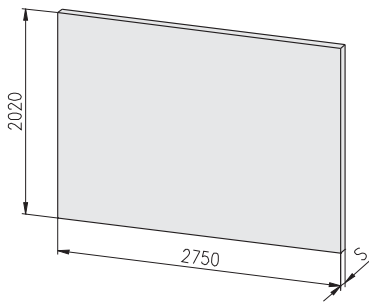

Description	S	RAL	Weight	Article-No.
Chipboard	8	7035	32 kg	1.82.083.00
Chipboard	16	7035	64 kg	1.82.163.00
Chipboard	19	7035	75 kg	1.82.193.00

**Solid plastic panels**  
**coated with melamine**

Technical data	
surface:	both sides coated with melamine
structure:	mini pearl
RAL 7035:	light grey
solid plastic panel:	made of Phenolplastic high pressure plate (HPL) of laminated material with all generally known merits of this substance.
Technical values on DIN 19926 and 53799	
bulk density:	approx. 1,500 kg/m <sup>3</sup>
thickness tolerance:	-0.6 mm
weight:	S = 4 mm    6 kg/m <sup>2</sup> S = 8 mm    12 kg/m <sup>2</sup>
cut to length:	1.83.□□□-99/□□□□×□□□□    type 1.83.□□□-99/□□□□×□□□□    length×width in mm 1.83.□□□-99/□□□□×□□□□

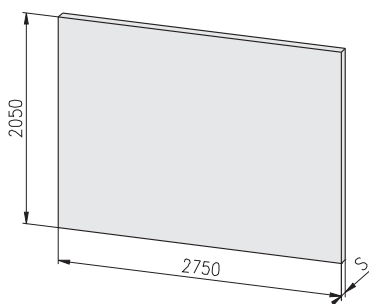

Description	S	RAL	Weight	Article-No.
Solid plastic panel	4	7035	33 kg	1.83.043.00
Solid plastic panel	8	7035	66 kg	1.83.083.00

Alu-plastic composite panels

Technical data	
alu-plastic composite panel:	PE with alu coating on both sides
surface:	natural anodised, E6/EV1
temperature resistance:	- 50°C to 80°C
chemical resistance:	resistant against organic food, light acid contents and alkaline solutions, gasoline, oil
thickness tolerance:	-0.6 mm
weight:	S = 4 mm 5.5 kg/m <sup>2</sup> S = 6 mm 7.3 kg/m <sup>2</sup>
cut to length:	1.85.□□□-99/□□□□×□□□□ 1.85.□□□-99/□□□□×□□□□ type 1.85.□□□-99/□□□□×□□□□ length×width in mm

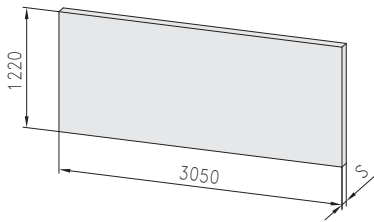

Description	S	Weight	Article-No.
Alu-plastic composite panel	4	20.5 kg	1.85.040.00
Alu-plastic composite panel	6	27.2 kg	1.85.060.00

**Polycarbonate (Makrolon)**

**Application**

Doors, panels and guards with stringent security requirements as polycarbonate offers high impact resistance and strength against breakage

Technical data	
thickness tolerance:	+0.8 mm
weight:	S = 4 mm 4.8 kg/m <sup>2</sup> S = 5 mm 6.0 kg/m <sup>2</sup> S = 6 mm 7.2 kg/m <sup>2</sup> S = 8 mm 9.6 kg/m <sup>2</sup>
cut to length:	1.87.□□□-99/□□□□×□□□□ 1.87.□□□-99/□□□□×□□□□ type 1.87.□□□-99/□□□□×□□□□ length×width in mm
Mechanical properties at 20 °C	
maximum extent of flex	68.7 MN/m <sup>2</sup>
break / shear point	> 110.0 %
compression	78.5 MN/m <sup>2</sup>
elasticity	2,256.0 MN/m <sup>2</sup>
marring resistance	392.4 J/m <sup>2</sup>
impact resistance (kJ/m <sup>2</sup> )	no break
tensile strength	68.7 MN/m <sup>2</sup>
Thermal properties	
temperature distortion according to 'Vicat'	170 °C
melting point	170 °C
temperature range under static load	-100 °C to 130 °C

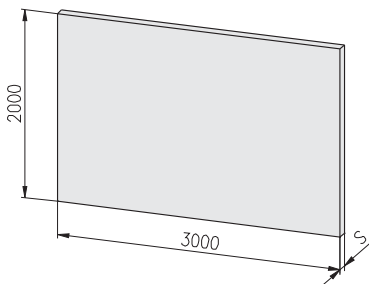

Description	S	Colour	Weight	Article-No.
Polycarbonate	4	transparent	28.8 kg	1.87.041.00
Polycarbonate	4	UV bronze 2850	28.8 kg	1.87.042.00
Polycarbonate	5	transparent	36.0 kg	1.87.051.00
Polycarbonate	5	UV bronze 2850	36.0 kg	1.87.052.00
Polycarbonate	6	transparent	43.2 kg	1.87.061.00
Polycarbonate	6	UV bronze 2850	43.2 kg	1.87.062.00
Polycarbonate	8	transparent	57.6 kg	1.87.081.00
Polycarbonate	8	UV bronze 2850	57.6 kg	1.87.082.00

**Wire net, Alu**

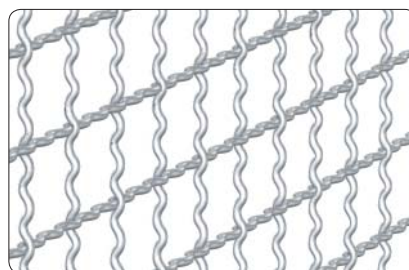

**Application**

For protective coverings and partition walls

**Comments**

Mounting in the profile:

- with sponge rubber 1.41.6□□
- with wire net m. prof. 1.19.1423...
- with wedge profile 1.41.51E□.□
- with framing profile 1.41.710.□
- with mounting sockets 1.81.510□□

Technical data	
material:	Aluminium
surface:	bare
weight:	3×20×20 mm 1.85 kg/m <sup>2</sup> 4×30×30 mm 2.25 kg/m <sup>2</sup>
length of ring:	25 m
cut to length:	1.88.□□□-99/□□□□×□□□□ 1.88.□□□-99/□□□□×□□□□ type 1.88.□□□-99/□□□□×□□□□ length×width in mm

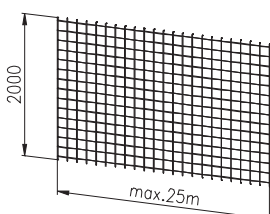

Description	Weight	Article-No.
Wire net, Alu 3×20×20	92.5 kg	1.88.322.00
Wire net, Alu 4×30×30	112.5 kg	1.88.433.00

Wire net, steel

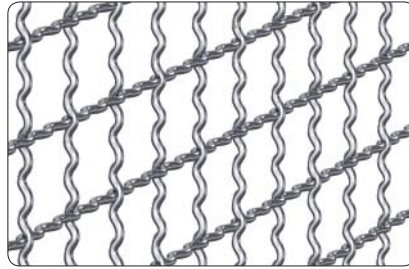

Application

For protective coverings and partition walls

Comments

Mounting in the profile:

- with sponge rubber 1.41.6□□
- with wire net m. prof. 1.19.1423...
- with wedge profile 1.41.51E□.□
- with framing profile 1.41.710.□
- with mounting sockets 1.81.510□□

Technical data	
material:	steel
surface:	galvanised
weight:	4×30×30 mm 27 kg/plate 4×40×40 mm 24 kg/plate
size of plate:	3,000×1,810 mm
cut to length:	1.88.□□□-99/□□□□×□□□□ 1.88.□□□-99/□□□□×□□□□ type 1.88.□□□-99/□□□□×□□□□ length×width in mm

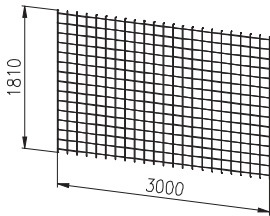

Description	Weight	Article-No.
Wire net, steel 4×30×30	27 kg	1.88.143030.00
Wire net, steel 4×40×40	24 kg	1.88.144040.00

Grid, steel welded

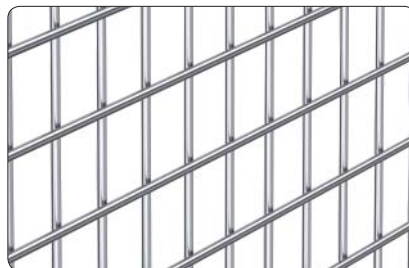

Application

For protective coverings and partition walls

Comments

Mounting in the profile:

- with sponge rubber 1.41.6□□
- with wire net m. prof. 1.19.1423...
- with wedge profile 1.41.51E□.□
- with framing profile 1.41.710.□
- with mounting sockets 1.81.510□□

Technical data	
material:	steel
surface:	electrogalvanised
weight:	3×25×25 mm 8.9 kg/plate 4×40×40 mm 9.8 kg/plate
size of plate:	2,000×1,000 mm
cut to length:	1.88.□□□-99/□□□□×□□□□ 1.88.□□□-99/□□□□×□□□□ type 1.88.□□□-99/□□□□×□□□□ length×width in mm

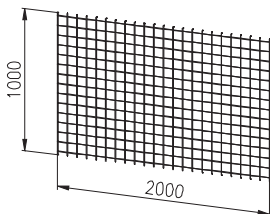

Description	Weight	Article-No.
Grid, steel 3×25×25	8.9 kg	1.88.232525.00
Grid, steel 4×40×40	9.8 kg	1.88.244040.00



Self locking washers  
DIN 25201

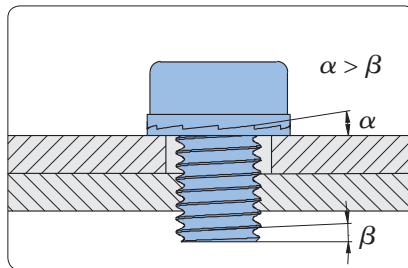
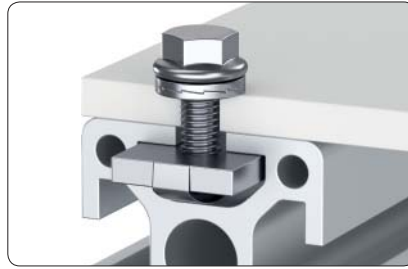

The cam angle  $\alpha$  of the washers is larger than the thread pitch  $\beta$  of the bolt.

Advantages

- Maximum safety during the tightening of the screw
- Reliable connection under extreme vibration and dynamic loads
- Ease of assembly and disassembly
- Positive locking at low and high preload levels
- Same temperature characteristics as standard nut & bolt
- Surface protection
- Reusable

The outside dimensions of the locking washer guarantees it's effectiveness even when used in countersunk holes. Washers with enlarged outer diameter (SP) in combination with flanged nuts / bolts are recommended for use on large / long holes, painted surfaces or soft materials, e.g. aluminium.

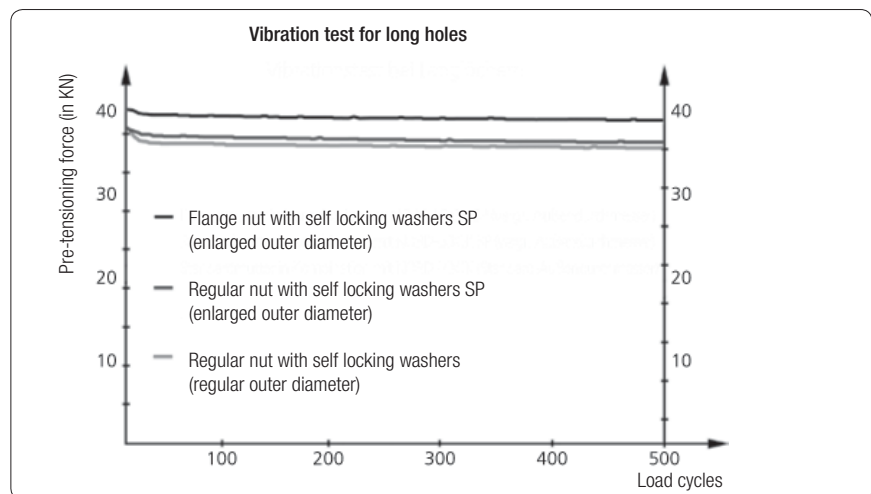

Junker vibration test for bolt M12 (8.8)

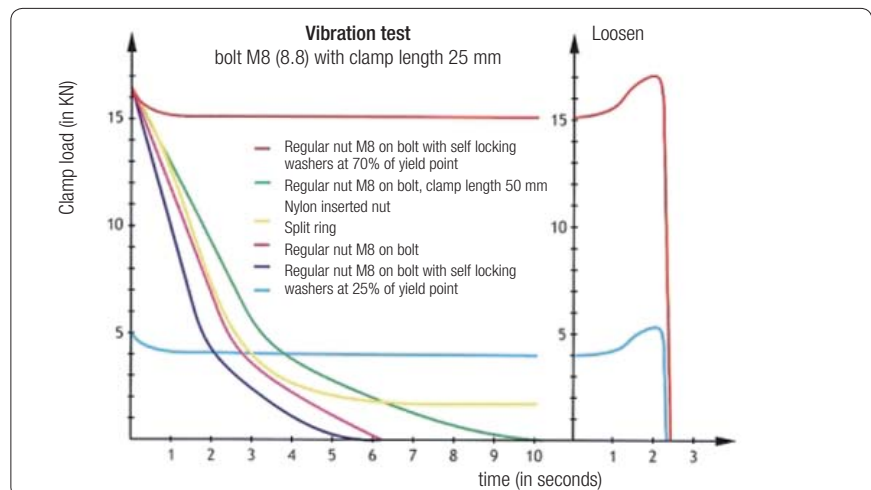

Test results

Self locking washers  
standard

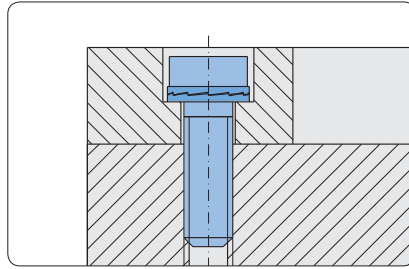

Cylindrical head screw DIN 6912 with self locking washers, standard

Self locking washers SP  
(enlarged outer diameter)

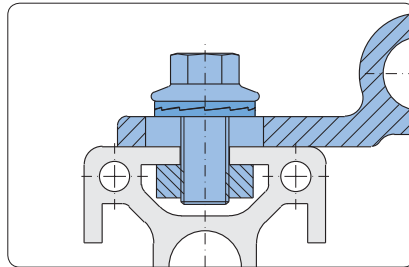

Hexagonal flange head screw DIN 6912 and self locking washers SP

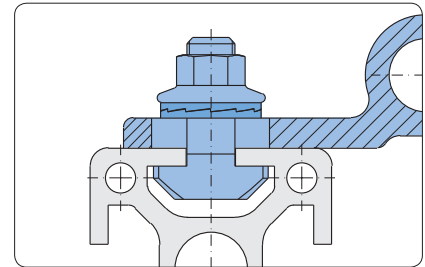

T-screw with flange nut DIN 6923 and self locking washers SP

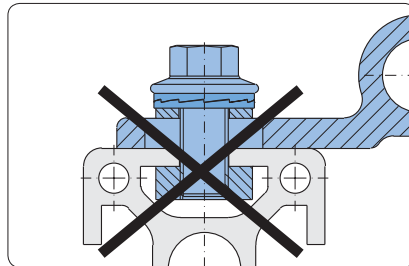

Do not use washers that are not secured in position

Technical data

material:

- steel: Zinc flake coated, pre-assembled in pairs (glued)
- stainless steel: 1.4404, pre-assembled in pairs (glued)

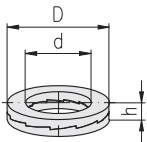

Description	D	h	d	Weight	Article-No.
<b>Standard / steel</b>					
Self locking washers, M6	10.8	1.8	6.5	0.7 g	0.62.D2520106
Self locking washers, M8	13.5	2.5	8.7	1.5 g	0.62.D2520108
Self locking washers, M10	16.6	2.5	10.7	2.3 g	0.62.D2520110
<b>Standard / stainless steel</b>					
<input type="checkbox"/> <input type="checkbox"/> Self locking washers, M6, SS	10.8	2.2	6.5	0.9 g	0.62.D2520106SS
<input type="checkbox"/> <input type="checkbox"/> Self locking washers, M8, SS	13.5	2.2	8.7	1.2 g	0.62.D2520108SS
<input type="checkbox"/> <input type="checkbox"/> Self locking washers, M10, SS	16.6	2.2	10.7	1.6 g	0.62.D2520110SS
<b>SP / steel</b>					
Self locking washers, M6, SP	13.5	2.5	6.5	2.0 g	0.62.D2520106SP
Self locking washers, M8, SP	16.6	2.5	8.7	2.9 g	0.62.D2520108SP
Self locking washers, M10, SP	21.0	2.5	10.7	4.4 g	0.62.D2520110SP
<b>SP / stainless steel</b>					
<input type="checkbox"/> <input type="checkbox"/> Self locking washers, M6, SPSS	13.5	2.2	6.5	1.6 g	0.62.D2520106SPSS
<input type="checkbox"/> <input type="checkbox"/> Self locking washers, M8, SPSS	16.6	2.2	8.7	2.4 g	0.62.D2520108SPSS
<input type="checkbox"/> <input type="checkbox"/> Self locking washers, M10, SPSS	21.0	2.2	10.7	3.7 g	0.62.D2520110SPSS

**Button head screws**



**Application**

Button head screws for the mounting of additional elements

**Technical data**

material: steel  
surface: galvanised

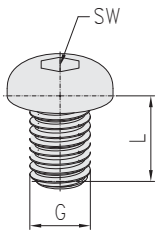

Description	G×L	SW	Weight	Article-No.
Button head screw	M5×12	3	2.4 g	0.63.WN7380.05012
Button head screw	M8×12	5	6.5 g	0.63.WN7380.08012
Button head screw	M8×18	5	8.5 g	0.63.WN7380.08018
Button head screw	M8×30	5	12.6 g	0.63.WN7380.08030

**Lens head screws**

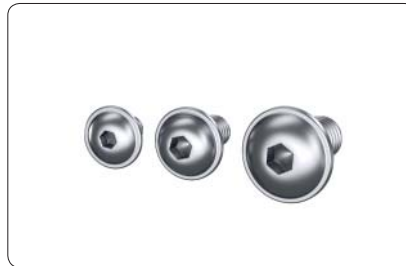

**Application**

Lens head screws for the mounting of additional elements

**Technical data**

material: steel  
surface: galvanised

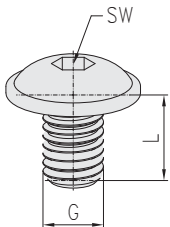

Description	G×L	SW	Weight	Article-No.
Lens head screw	M5×6	3	2.0 g	0.63.WN7381.05006
Lens head screw	M5×8	3	2.0 g	0.63.WN7381.05008
Lens head screw	M6×10	4	3.0 g	0.63.WN7381.06010
Lens head screw	M6×12	4	4.0 g	0.63.WN7381.06012
Lens head screw	M8×12	5	8.0 g	0.63.WN7381.08012
Lens head screw	M8×16	5	9.0 g	0.63.WN7381.08016

Press in device  
for knurled cross bushing



Technical data

Base body:

- material: aluminium
- surface: natural anodised

Axle bolt, spring:

- material: stainless steel

Other:

- material: steel
- surface: galvanised

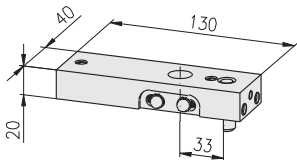

Description	Weight	Article-No.
Press in device for knurled cross bushing	310.0 g	1.98.11.21.B00R

Single parts	Pcs	Weight	Article-No.
Base body	1	216.0 g	1.98.11.21.B00R/01
Stopping pin	1	21.2 g	1.99.01112-05
Set screw for stop pin	1	1.8 g	1.99.01112-06
Dowel pin ISO 8752 (DIN 1481), 8×24 (for drill jig)	2	6.5 g	0.69.I08752.08024
Axle bolt complete, Ø8g 6×35 mm	2	15.6 g	1.98.11.21.B00R/05
Hex-socket set screw, DIN 913, M8×25	4	6.6 g	0.63.D00913.08025
Spring for T-screw, E	4	0.1 g	1.34.E00/02

Hexagonal tools

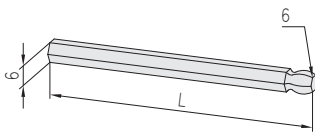

Description	L	Drive	Weight	Article-No.
Hexagonal bit with ballhead wrench size 6	100	6	23 g	1.98.IN.SW6.100

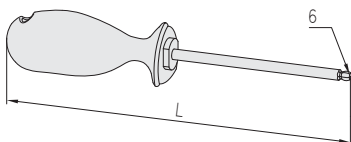

Description	L	Weight	Article-No.
Hexagonal screwdriver with ballhead wrench size 6	215	122 g	1.98.IN.SW6.215

Torx® Tools

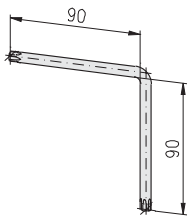

**Technical data**

material: steel, hardened

surface: nickel-plated

Description	Weight	Article-No.
Tx screw driver for TX 40 screws	54 g	1.98.T40.090090

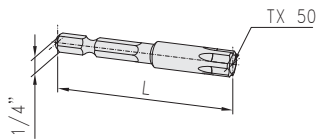

Description	L	Drive	Weight	Article-No.
Screw bit TX 50	50	C 6.3 (1/4")	16 g	1.98.TX50A1/4

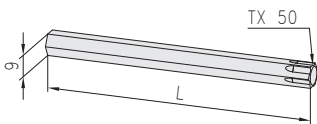

Description	L	Drive	Weight	Article-No.
Screw bit TX 50	95	9	49 g	1.98.TX50A09

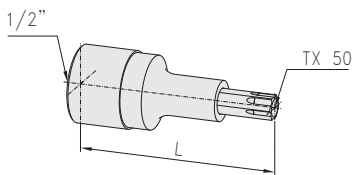

Description	L	Weight	Article-No.
Screwdriver insert TX 50	55	72 g	1.98.TX50A1/2

Cross bushings / Anchors			Drill									Milling cutter						
			MK		cylindrical shaft							cylindrical shaft						
			1.99.03115452	1.99.03115454	1.99.0310800	1.99.0310645	1.99.03109000	1.99.03109452	1.99.0311245	1.99.03215452	1.99.03215454	1.99.0210645	1.99.02109000	1.99.02109452	1.99.02112451	1.99.02115000	1.99.02115452	1.99.02115454
Slot	Description	drill-Ø chamfer ×45° shaft-Ø	15.25 1.5 MK	15.25 3.5 MK	6/8.5 - 8.5	6.2 2.0 6.2	9.2 - 9.2	9.2 1.5 9.2	12.2 2.0 12.2	15.25 1.5 12.0	15.25 3.5 12.0	6.2 2.0 10.0	9.2 - 10.0	9.2 1.5 10.0	12.2 1.0 12.0	15.25 - 16.0	15.25 1.5 16.0	15.25 3.5 16.0
<b>Cross bushing</b>																		
  	Standard						●						●					
  	for profile 20×20, soft							●						●				
  	Standard		●								●					●	●	
  	for profile • 30×30, soft • 30×100 • 30×150			●														●
  	for profile 40×40, 2E 45°, LP			●														●
  	for ST-Connector, profile 30×150		●	●														●
  	for SE-Connector																	●
  	for ST-Connector		●															●
  	for ST-Connector with anchor, screw-type																	●
<b>Anchor</b>																		
  	for connector, parallel						●											●
  	for connector, parallel																	●
  	for connector, miter, hinge				●													

**Drill jigs  
for profiles with H-slots**



Drill jig with setscrew



Drill jig with clamping lever

**Application**

Tools for precise machining of connection bore

- for drilling machine: - drill jig  
- drill
- for milling machine: - milling cutter
- the drill jig is located and fastened in the profile slot
- suitable for any profile angle cut

**Technical data**

Base body:

- material: aluminium
- surface: natural anodised

Drill bush:

- material: steel
- surface: hardened and polished

**Drill jig  
with setscrew**

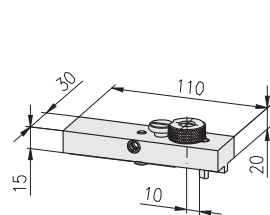

Description	Weight	Article-No.
Drill jig H with setscrew	189 g	1.99.01011
Single parts		
Weight	Article-No.	
Base body	120 g	1.99.01012-01
Drill bush for cross bushing, Ø9.2	50 g	1.99.01012-03
Safety screw for drill bush, M6×4	6 g	1.99.01012-04
Stop pin	2 g	1.99.01012-05
Connector	11 g	1.20.3/2H5

**Accessories**

Drill bush for parallel-anchor, Ø6.2	43 g	1.99.01012-02
--------------------------------------	------	---------------

**Drill jig  
with clamping lever**

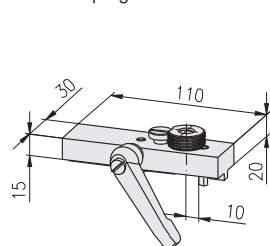

Description	Weight	Article-No.
Drill jig H with clamping lever	225 g	1.99.01012
Single parts		
Weight	Article-No.	
Base body	120 g	1.99.01012-01
Drill bush for cross bushing, Ø9.2	50 g	1.99.01012-03
Safety screw for drill bush, M6×4	6 g	1.99.01012-04
Stop pin	2 g	1.99.01012-05
Connector	11 g	1.20.3/2H5
Clamping lever 65, for connector, M6×20	36 g	1.29.650620

**Accessories**

Drill bush for parallel-anchor, Ø6.2	43 g	1.99.01012-02
--------------------------------------	------	---------------

**Tools**  
for profiles with H-slots



Drill, Milling cutter

**Comments**  
Selection range ↗ 333

**Milling cutter**

- parallel-anchor
- cross bushing

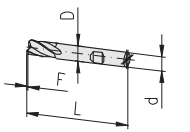

**Technical data**

material: HSS  
3 cutting edges  
cutting geometry for aluminium machining  
off-centre cutting edges

Description	D	L	F	d	Weight	Article-No.
Milling cutter f. par.-anchor	Ø6.2	60	2.0×45°	8	13 g	1.99.0210645
Milling cutter f. cross bush.	Ø9.2	70	without	10	34 g	1.99.0210900
Milling cutter f. cross bush.	Ø9.2	70	1.5×45°	10	34 g	1.99.02109452

**Drill**

- parallel-anchor
- cross bushing

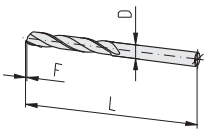

**Technical data**

material: HSS  
2 cutting edges  
cutting geometry for aluminium machining  
off-centre cutting edges

Description	D	L	F	Weight	Article-No.
Drill for parallel-anchor	Ø6.2	100	2.0×45°	16 g	1.99.0310645
Drill for cross bushing	Ø9.2	120	without	43 g	1.99.03109000
Drill for cross bushing	Ø9.2	120	1.5×45°	43 g	1.99.03109452

**Drill**

for miter anchor

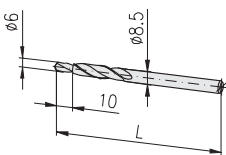

**Technical data**

material: HSS  
2 cutting edges  
cutting geometry for aluminium machining

**Application**

To drill core hole

**Comments**

Machining instruction ↗ 94, 1.2A

Description	D	L	Weight	Article-No.
Drill for miter anchor	Ø8.5	120	34 g	1.99.0310800



**Drill jigs**  
for profiles with F- and E-slots



Drill jig with setscrew



Drill jig with clamping lever

**Application**

Tools for precise machining of connection bore

- for drilling machine: - drill jig  
- drill
- for milling machine: - milling cutter
- the drill jig is located and fastened in the profile slot
- suitable for any profile angle cut

**Technical data**

Base body:

- material: aluminium
- surface: natural anodised

Drill bush:

- material: steel
- surface: hardened and polished

**Drill jig**  
with setscrew

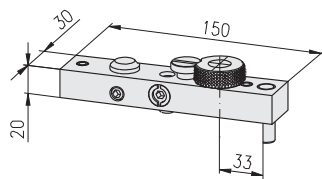

Description	Weight	Article-No.
Drill jig FE with setscrew	375 g	1.99.01111
<b>Single parts</b>		
Base body	188 g	1.99.01112-01
Drill bush for cross bushing, Ø15.25	105 g	1.99.01112-03
Safety screw for drill bush, M8×5.5	11 g	1.99.01112-04
Stop pin	19 g	1.99.01112-05
Setscrew for stop pin	2 g	1.99.01112-06
Connector, parallel-high	30 g	1.21.31/2F5
Anchor	20 g	1.21.A2E5

**Accessories**

Drill bush for parallel-anchor, Ø12.2	90 g	1.99.01112-02
---------------------------------------	------	---------------

**Drill jig**  
with clamping lever

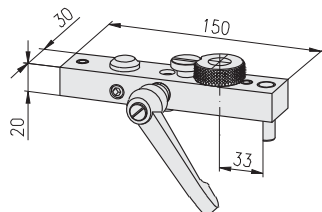

Description	Weight	Article-No.
Drill jig FE with clamping lever	438 g	1.99.01112
<b>Single parts</b>		
Base body	188 g	1.99.01112-01
Drill bush for cross bushing, Ø15.25	105 g	1.99.01112-03
Safety screw for drill bush, M8×5.5	11 g	1.99.01112-04
Stop pin	19 g	1.99.01112-05
Setscrew for stop pin	2 g	1.99.01112-06
Connector, parallel-high	30 g	1.21.31/2F5
Anchor	20 g	1.21.A2E5
Clamping lever 80, for connector, M10×20	63 g	1.29.801020

**Accessories**

Drill bush for parallel-anchor, Ø12.2	90 g	1.99.01112-02
---------------------------------------	------	---------------

**Tools**  
for profiles with F- and E-slots



Drill, Milling cutter

**Comments**  
Selection range ↗ 333

**Milling cutter**

- parallel-anchor
- cross bushing

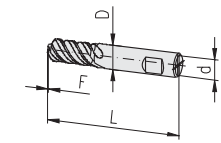

**Technical data**

material: HSS  
3 cutting edges  
cutting geometry for aluminium machining  
off-centre cutting edges

Description	D	L	F	d	Weight	Article-No.
Milling cutter f. cr. bush. ST, 4	Ø12.2	83	1×45°	Ø12	60 g	1.99.02112451
Milling cutter f. cross bush. SE	Ø15.2	93	without	Ø16	116 g	1.99.02115000
Milling cutter f. cross bush.	Ø15.2	93	1.5×45°	Ø16	116 g	1.99.02115452

**Drill**

for parallel-anchor

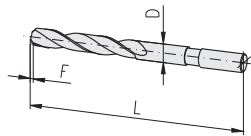

**Technical data**

material: HSS  
2 cutting edges  
cutting geometry for aluminium machining  
off-centre cutting edges

Description	D	L	F	Weight	Article-No.
Drill for parallel-anchor	Ø12.2	147	2×45°	93 g	1.99.0311245

**Drill**

for cross bushing

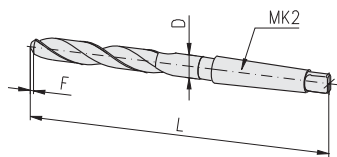

**Technical data**

material: HSS  
2 cutting edges  
cutting geometry for aluminium machining  
off-centre cutting edges

Description	D	L	F	Weight	Article-No.
Drill for cross bushing, MK2	Ø15.25	210	1.5×45°	224 g	1.99.03115452

**Drill**

for cross bushing

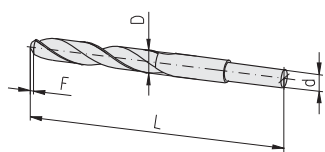

**Technical data**

material: HSS  
2 cutting edges  
cutting geometry for aluminium machining  
off-centre cutting edges

Description	D	L	F	d	Weight	Article-No.
Drill for cross bushing	Ø15.25	173	1.5×45°	Ø12	197 g	1.99.03215452

**Tools**  
for profiles with F- and E-slots



Drill, Milling cutter

**Comments**  
Selection range ↗ 333

**Milling cutter**  
for cross bushing

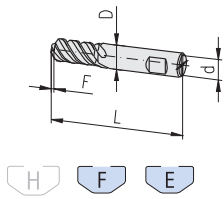

**Technical data**  
material: HSS  
4 cutting edges  
cutting geometry for aluminium machining  
off-centre cutting edges

Description	D	L	F	d	Weight	Article-No.
Milling cutter f. cross bush.	Ø15.2	93	4.0×45°	Ø16	116 g	1.99.02115454

**Drill**  
for cross bushing

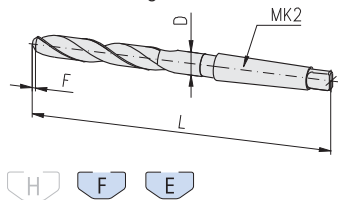

**Technical data**  
material: HSS  
2 cutting edges  
cutting geometry for aluminium machining  
off-centre cutting edges

Description	D	L	F	Weight	Article-No.
Drill for cross bushing, MK2	Ø15.25	210	4.0×45°	224 g	1.99.03115454

**Drill**  
for cross bushing

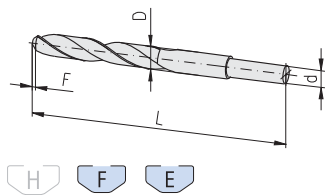

**Technical data**  
material: HSS  
2 cutting edges  
cutting geometry for aluminium machining  
off-centre cutting edges

Description	D	L	F	d	Weight	Article-No.
Drill for cross bushing	Ø15.25	173	4.0×45°	Ø12	197 g	1.99.03215454

**Screw taps  
for aluminium machining**

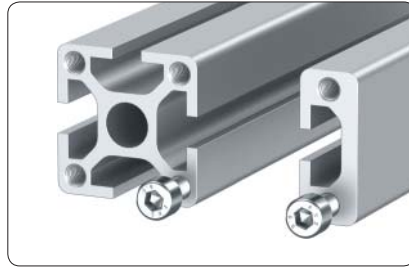

**Application**

Mounting threads in profile centre core hole  
Ø5 mm

**Screw tap  
M6**

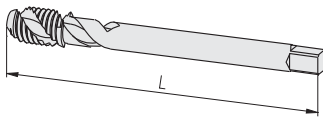

16 20 30 40 45 50 60

**Technical data**

material: HSS/E

machine threading tap:

- right hand cutting, 40° right spiral fluted
- enlarged chip flute
- 3-pitch thread start
- tolerance class: 6H

Description	G	L	Weight	Article-No.
Screw tap	M6	80	45 g	1.99.0406080



**Application**

Mounting threads in profile centre core hole  
Ø6.2 mm

**Screw tap  
M8**

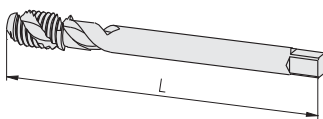

16 20 30 40 45 50 60

**Technical data**

material: HSS/E

machine threading tap:

- right hand cutting, 40° right spiral fluted
- enlarged chip flute
- 3-pitch thread start
- tolerance class: 6H

Description	G	L	Weight	Article-No.
Screw tap	M8	90	52 g	1.99.0408090

**Screw taps  
for aluminium machining**

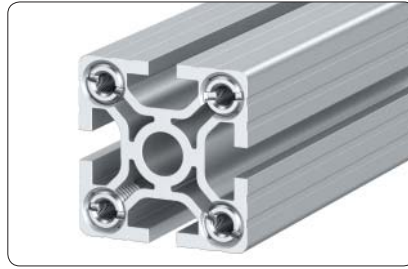

**Application**

Fastening thread in hollow chambers of profiles PG 50

**Screw tap  
M12**

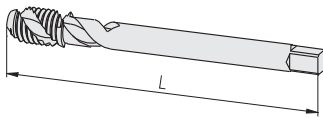

16 20 30 40 45 50 60

**Technical data**

material: HSS/E

machine threading tap:

- right hand cutting, 40° right spiral fluted
- enlarged chip flute
- 2-pitch thread start
- tolerance class: 6H

Description	G	L	Weight	Article-No.
Screw tap	M12	110	65 g	1.99.0412110

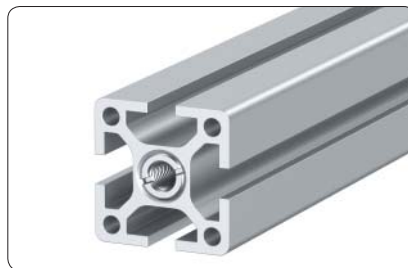

**Application**

Mounting threads in profile centre core hole Ø12 mm

**Screw tap  
M14**

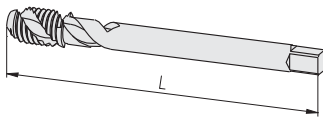

H F E

**Technical data**

material: HSS/E

machine threading tap:

- right hand cutting, 40° right spiral fluted
- enlarged chip flute
- 2-pitch thread start
- tolerance class: 6H

Description	G	L	Weight	Article-No.
Screw tap	M14	110	75 g	1.99.0414110
Screw tap	M14	150	105 g	1.99.0414150

<b>A</b>		
Abbreviations.....	5	
Accessories.....	137	
Additional accessories.....	138, 233	
Adjustable tilt-feet.....	185	
Adjustable tilt-feet - Single parts.....	185	
Adjustable tilt-foot anti-slip discs.....	189	
Adjustable tilt-foot cushion elements.....	189	
Adjustable tilt-foot plates.....	186	
with mounting holes.....	187	
without mounting holes.....	186	
Adjustable tilt-foot plates with mounting holes.....	187	
GD-Zn.....	187	
PA.....	187	
Stainless steel.....	187	
Adjustable tilt-foot plates without mounting holes.....	186	
GD-Zn.....	186	
PA.....	186	
Stainless steel.....	186	
Adjustable tilt-foot spindles.....	188	
Stainless steel.....	188	
Steel.....	188	
Alu hinges.....	251	
heavy.....	253	
Press-fit pins for alu hinges.....	252	
Spacer.....	252	
Type A.....	251	
Type B.....	251	
Type C.....	252	
Alu hinges, heavy.....	253	
Alu-plastic composite panel.....	325	
Angles.....	202	
25×40.....	202	
Alu.....	208	
GD-Al.....	207	
GD-Zn.....	204	
PA.....	203	
Swivel angles.....	209	
Angular adjusting feet.....	190	
with adjusting screw.....	190	
without adjusting screw.....	190	
Angular tolerance.....	66	
Anti-twist devices.....	134	
for subsequent insertion.....	135	
Approximate determination of deflection.....	67	
Article-No. for connector.....	94, 96	
E-head.....	94, 96	
F-head.....	94, 96	
H-head.....	94, 96	
<b>B</b>		
Bar locks.....	279	
Assembly accessories.....	281	
Olive installation sets.....	282	
Profile machining.....	280	
Base angle.....	197	
Base feet.....	191, 192	
Floor mounting sets.....	191, 195	
Profile mounting sets.....	196	
Base plates.....	211	
with thread.....	212	
without thread.....	212	
Bending strength.....	66	
Block for cable binder.....	307	
Bores for parallel-connector.....	60	
Bullet catches.....	267	
PA.....	268	
Button head screws.....	330	
<b>C</b>		
Cable and hose clamp.....	306	
Cable binder detachable.....	307	
Calculation formulas for polygons.....	129	
Carabine swivel.....	303	
Castors.....	198	
Fixed castors.....	198	
Fixed castors with fitting plate.....	198	
Locking castors.....	200	
Swivel castors.....	199	
Swivel castors lockable.....	199	
Swivel castors lockable with fitting plate.....	199	
Swivel castors with bolt hole.....	199	
Swivel castors with fitting plate.....	199	
Threaded bolt for locking castor with center thread.....	201	
Chipboards.....	324	
Clamping for guidance system.....	296	
Clamping levers.....	136	
40 for connector.....	136	
65 for connector.....	136	
80 for connector.....	136	
Coding examples (profile machining).....	62	
for price group 1.....	62	
for price group 2.....	63	
for price group 3.....	64	
Combination profiles.....	160, 163	
Connection elements.....	133	
Anti-twist devices.....	133	
Connection of 0-slot profiles.....	122	
with screw-type connector.....	127	
with standard connector.....	126	
Connection of profiles 40, round.....	129	
Calculation formulas for polygons.....	129	
Connection plates.....	215	
Connection possibilities.....	122	
for 0-slot profiles.....	122	
for profiles 40, round.....	129	
Other profile systems.....	131	
Special cases.....	130	
Subsequent mounting of profiles.....	130	
Connection System.....	85	
Connection variants with screw-type connectors.....	94, 100	
Connector.....	94	
Connector screw.....	101	
Connector screw-self-cutting.....	101, 116	
Cross connector.....	117	
Extension.....	94, 98	
Extension / parallel connector.....	111	
Insertion connector.....	119	
Miter 90°-bent anchor l.....	99	
Miter 90°-bent anchor r.....	99	
Miter 90°-hinge l + r.....	94, 99	
Miter-bent anchor l + r.....	99	
Miter-hinge l + r.....	94, 99	
Oblique 90°-bent anchor.....	97	
Oblique 90°-bent anchor 90°.....	97	
Oblique 90°-hinge.....	94, 97	
Oblique-bent anchor l.....	96	
Oblique-bent anchor r.....	97	
Oblique-bent anchor standard l.....	97	
Oblique-bent anchor standard r.....	97	
Oblique-cross-hinge.....	97	
Oblique-cross-hinge 90°.....	97	
Oblique-hinge l + r.....	94, 96	
Parallel connector.....	110	
Parallel connector for subsequent insertion.....	118	
Parallel-cross.....	94, 98	
Parallel-high.....	94, 98	
Parallel-high 90°.....	98	
Parallel-square.....	94, 98	
Screw-type front sided.....	94, 100	
Screw-type parallel-cross.....	94, 100	
Screw-type parallel-high.....	94, 100	
Screw-type parallel-square.....	94, 100	
SE-Connector.....	113	
Shifter.....	99	
Square head Standard.....	96	
Square head Standard 90°.....	96	
Square head Universal.....	96	
Standard.....	96	
Standard 90°.....	96	
ST-Connector.....	114	
ST-Connector with anchor, screw-type.....	115	
Universal.....	94, 96	
Universal connector with knurled cross bushing.....	112	
Connector - Drill dimensions.....	122	
with radius covers.....	122	
without radius covers.....	122	
Connector complete.....	105, 106	
PG 20.....	105, 106	
PG 20.....	106	
PG 30.....	106	
PG 40.....	107	
PG 45.....	107	
PG 50.....	107	
PG 60.....	107	
Connector components.....	105	
Anchor.....	105, 106	
Cross bushing.....	105, 107	
Setscrew.....	107	
Connector Cross bushings.....	102	
Drill dimensions for connector cross bushings - special cases.....	103	
Mounting variants.....	103	
Connector screw self-cutting.....	116	
Connectors.....	92	
Connector complete.....	105	
Cross bushings.....	102	
Drill dimensions.....	122	
Examples.....	89	
for core hole-Ø 12 mm.....	106	
for core hole-Ø 6 mm.....	105	
Manufacture a connection.....	92	
Mounting in core hole.....	88	
Mounting in slot.....	89	
Selection.....	93	

- Special cases ..... 110  
 Summary ..... 88  
 Types and materials ..... 93  
 Connectors - special cases ..... 93, 110  
 Corner elements ..... 320  
   33 for wire net mounting  
     profile 33×10 ..... 321  
     for wire net mounting profile ..... 320  
 Corner pieces ..... 218  
   45° ..... 220  
   angle ..... 218  
   connection with corner pieces ..... 221  
   cubic ..... 219, 222  
   segment ..... 222  
   spherical ..... 220, 222  
 Cover caps ..... 173  
   for profiles with core hole-Ø12 ..... 174  
   for profiles with core hole-Ø6 ..... 173  
   for profiles without core hole ..... 173  
   for screw bores ..... 178  
   for tube profiles ..... 173  
   for tubes ..... 178  
   Ø48 for hand rail profile ..... 175  
   for connector cross bushing ..... 122  
 Cover plugs ..... 176  
   domed ..... 177  
 Cover profiles ..... 157  
   Alu ..... 157  
   PVC ..... 157  
 Cross bore ..... 60  
 Cross bushing bore for connector ..... 60  
 Cross connection plates ..... 210  
 Cross connector ..... 117  
 Cross section of slots ..... 6  
 Cross-blocks for cable binder ..... 307  
 C-track ..... 57  
 Curved profiles ..... 83  
 Cylinder locks ..... 271  
   flush ..... 273  
   with security latch ..... 272
- D**  
 Delivery length ..... 65  
 Determination of deflection ..... 66  
 Direction and Position ..... 61  
 Distance washer ..... 297  
 Distancing plate, thin ..... 261  
 Door handle ..... 278  
 Door knob ..... 278  
 Double hinge ..... 245  
 Drill dimensions for connector cross  
   bushings ..... 102  
   Special cases ..... 103  
 Drill jigs ..... 334, 336  
   for profiles with F- and E-slots ..... 336  
   for profiles with H-slots ..... 334  
   with clamping lever ..... 334, 336  
   with setscrew ..... 334, 336  
 Drills ..... 335, 337
- E**  
 E3-slot ..... 6  
 E4-slot ..... 6  
 Eco-Slides ..... 298  
 Edge roller ..... 291
- Electrical accessories ..... 139, 304  
 Electrical installation trunking ..... 316  
 E-trunking ..... 316  
   end plates ..... 318  
   for clips ..... 319  
   lids ..... 317  
 E-trunking profiles ..... 52  
   Base profiles ..... 52  
   Cover profiles ..... 52  
 Extruded profile as per DIN EN 12020 ..... 65  
 Eye-bolt ..... 217
- F**  
 Fastening elements ..... 135  
 Fastening plate 30×150 ..... 216  
 Finished dimensions ..... 94  
   for profiles with core hole-Ø12 ..... 96  
   for profiles with core hole-Ø6 ..... 94  
 Fixed castors ..... 198  
   with bolt hole ..... 198  
   with fitting plate ..... 198  
 Flap-lock countersunk ..... 273  
 Flatness of profile surfaces ..... 65  
 Flatness tolerance ..... 65  
 Flexure load ..... 132  
 Floor levelling screw ..... 182  
 Floor mounting plate ..... 213  
 Floor plate ..... 214  
 Framing profiles ..... 165, 170  
   one piece ..... 165  
 F-slot ..... 6  
 Functional length ..... 65
- G**  
 Grab handle profiles ..... 56, 238  
 Grab handles ..... 238  
   Cover cap kit left/right ..... 238  
 Grid, steel ..... 327  
 Ground connections ..... 305  
 Guidance system ..... 295  
   Clamping ..... 296  
   Distance washer ..... 297  
   Sliding blocks ..... 296  
   T-Nut sliding blocks ..... 297  
 Guide profile PVC ..... 164
- H**  
 Hand adjustable feet ..... 183  
 Hand rail ..... 76  
 Handle system ..... 236  
   oval design ..... 237  
   round design ..... 236  
 Handles ..... 233  
   light Alu ..... 233  
   light PA ..... 233  
   PA ..... 234  
   PA with bore ..... 234  
   PA with thread ..... 234  
 Hanging bracket for safety barriers ..... 302  
 Hexagonal tools ..... 331  
 Hinges ..... 239, 244, 246  
   Alu hinges ..... 251  
   Alu hinges, heavy ..... 253  
   Double hinge ..... 245  
   Lift-off hinges ..... 240
- I**  
 Insertion connector ..... 119  
 Installation accessories ..... 137, 157  
 Installation rings ..... 308
- J**  
 Joints ..... 255  
   with / without clamping lever ..... 255  
   Zn with / without clamping lever ..... 257
- L**  
 Latch locks ..... 283  
 Lens head screws ..... 330  
 Levelling feet ..... 182, 184  
   Levelling furniture foot ..... 184  
 Levelling furniture foot ..... 184  
 Lock GD-Zn ..... 270  
 Lock mounting set ..... 282  
   with double beard key ..... 282  
   with square key ..... 282  
 Locking castors ..... 200  
   with center thread ..... 201  
   with plate ..... 200
- M**  
 Machining of profiles with core hole-Ø6 ..... 94  
   for miter ..... 94  
 Magnetic lock PA ..... 269  
 Makrolon ..... 326  
 MayCAD ..... 2  
 MayTec connector with square head ..... 87  
 MayTec ground-connector for potential  
   equilisation ..... 87  
 MayTec screw-type connector ..... 87  
 MayTec standard-connector ..... 87  
 MayTec universal-connector ..... 87  
 Mechanical data ..... 65  
 Milling cutter ..... 335, 337  
 Mortise deadlocks ..... 275  
   cases ..... 276  
   Door handle ..... 278  
   Door knob ..... 278  
   Installation sets ..... 276  
   Profile machining ..... 275  
   Push pins ..... 278  
 Mortise deadlocks cases ..... 276  
   with lock ..... 277  
   without lock ..... 276  
 Mortise deadlocks installation sets ..... 276  
   with lock ..... 277  
   without lock ..... 276  
 Mounting adaptor for roller ..... 290  
 Mounting blocks ..... 258  
   for subsequent insertion ..... 260  
   GD-Zn ..... 259  
   screw-type ..... 258  
 Mounting clamp blocks ..... 262  
   for subsequent insertion ..... 262  
   SL ..... 264  
 Mounting instruction for screw-type  
   connectors ..... 94, 100  
 Mounting of connector ..... 88  
   in core hole ..... 88  
   in slot ..... 89



Mounting plates.....	214	Profile applications.....	72	Rhomboid T-slot nuts .....	151
Mounting set for 19" profile.....	309	Profile combinations.....	72	with self locking.....	151
Mounting sockets.....	322	Profile group.....	13	Roller 29 .....	285
Mounting variation .....	124	16 mm, E3-slot, P .....	13	Twin track guide .....	285
for high flexure load.....	125	16 mm, F-slot, P .....	14	Roller 39 .....	284
for high sliding load .....	124	20 mm, F-slot, P .....	17	Roller fastening sets.....	286
<b>N</b>		20 mm, H-slot, P .....	15	A, double sided.....	287
Numerical key for articles .....	7	30 mm, E4-slot, P .....	18	A, one sided.....	287
Nuts.....	188	30 mm, F-slot .....	36	type A .....	286
Stainless steel .....	188	30 mm, F-slot, P .....	18	type B.....	288
Steel.....	188	40 mm, E3-slot .....	38	Rubber cover-profiles .....	172
<b>O</b>		40 mm, E3-slot, P .....	22	Runner .....	292
Olive installation sets.....	282	45 mm, E4-slot .....	41	for sliding suspended doors.....	292
Order description .....	58	45 mm, E4-slot, P .....	30	Stopper Type 1 .....	293
Order examples for special design .....	64	50 mm, E4-slot .....	42	Stopper Type 2 .....	293
Oval tube.....	56, 237	50 mm, E4-slot, P .....	33	<b>S</b>	
<b>P</b>		60 mm, E4-slot .....	44	Safety interlocking-mountings.....	310
Panel bezel profiles .....	46	60 mm, E4-slot, P .....	34	for sliding door .....	311
30, F-slot, P .....	46	Profile machining .....	58	for swinging door.....	310
40, E3-slot, P .....	46	Bores for parallel-connector .....	60	Safety interlocking-mountings AZ17 .....	312
Panel elements.....	139, 323	Coding examples for price group 1 .....	62	for sliding door .....	313
Alu-plastic composite panel .....	325	Coding examples for price group 2 .....	63	for swinging door.....	312
Chipboards.....	324	Coding examples for price group 3 .....	64	Saw cut.....	59
Grid, steel .....	327	Coding examples for special design .....	64	Saw cut tolerance .....	59
Makrolon.....	326	Cross bore .....	60	Screw taps .....	339
Polycarbonate .....	326	Cross bushing bore for connector .....	60	Screws .....	330
Solid plastic panels.....	324	Direction and Position .....	61	Button head screws .....	330
Wire net, Alu .....	326	Order description.....	58	Lens head screws.....	330
Wire net, steel .....	327	Price group 1 .....	59	Sealing profile.....	169
Panel profiles.....	47	Price group 2 .....	59	SE-Connector .....	113
Panel profiles 30, F-slot, P .....	47	Price group 3 .....	59	Self locking washers .....	328
Panel profiles 40, E3-slot, P .....	48	Saw cut .....	59	Sensor brackets.....	315
Panel profiles 50, E4-slot, P .....	49	Saw cut tolerance.....	59	Slide load .....	132
Parallel connector .....	110	Summary .....	58	Sliding and cover profiles.....	158
for profile 30×30, soft .....	110	Thread.....	60	Sliding blocks .....	296
for subsequent insertion.....	118	Profile pre-cut lids.....	56	Sliding doors.....	162
Parallelism tolerance.....	66	30 .....	80	construction types .....	162
Pneumatic.....	223	40 .....	81	Sliding profiles .....	57
90° connection sets .....	231	50 .....	82	Slot plates .....	73
accessories.....	223	120 .....	318	E-slot.....	73
connection plate sets.....	229	Profile selection range.....	68	E-slot, slot distance 50 mm.....	75
connection plates .....	229	Profile tolerance.....	65	F-slot .....	73
end plate sets, with thread .....	227	Profiles 48, round (plain) .....	45	F-slot, slot distance 25 mm.....	74
end plate sets, without thread.....	225	Profiles for cable guide.....	79	F-slot, slot distance 50 mm.....	74
end plates.....	224	Slot distance 30 .....	80	Profile 30×100, 10F, SP .....	74
extension sets .....	230	Slot distance 40 .....	81	Profile 30×150, 8E, SP .....	75
Pneumatic accessories.....	138, 223, 232	Slot distance 50 .....	82	Profile 30×150, 8F, SP .....	74
Blanking plug .....	232	Profiles for pneumatic applications.....	223	Slot rollers.....	294
Reducing nipple.....	232	Profiles octagonal (plain).....	45	Slot system.....	6
Sealing ring.....	232	Push pins .....	278	E3-slot.....	6
Polycarbonate.....	326	<b>Q</b>		E4-slot.....	6
Potential equalisation .....	304	Quick locks.....	265	F-slot.....	6
Press in device for knurled cross bushing .....	331	<b>R</b>		H-slot .....	6
Press-fit pins for alu hinges .....	252	Radius compensations .....	181	Solid plastic panels .....	324
Press-fit threaded inserts .....	155	Radius covers .....	179	Spacer .....	252
without collar.....	155	Rectangle 90° with one radius .....	180	Special characters .....	5
Price groups (1 -3).....	59	Rectangle 90° with two radii .....	180	Special slits .....	72
Profile 20×30, 1F, LP .....	238	Rectangle with one radius .....	179	Specification of milling patterns for	
Profile 40, round 30° .....	129	Rectangle with two radii .....	180	closed profiles.....	123
Profile 40, round 45° .....	129	Square with one radius .....	179	Sponge rubber round cords .....	167
Profile 40, round 60° .....	129	Square with two radii .....	180	Spring-nuts .....	149
Profile 40, round 90° .....	129	Reducing profiles PVC.....	159	Spring-nuts .....	149
		Register .....	1	Stacking foot .....	197
				ST-Connector .....	114
				with anchor, screw-type .....	115



Straightness tolerance.....	65	Torque tightening values for connector setscrew .....	132
Strength values for profile connections .....	132	Torx® Tools .....	332
with MayTec-Connectors.....	132	T-slot nuts .....	150
Subsequent mounting of profiles.....	130	Tube profiles 30, P .....	51
Summary .....	8, 88, 137, 141, 333	Tubes .....	55
Accessories.....	137	Twin track guide for roller 29 .....	285
Connectors.....	88	Twist tolerance.....	65
Connectors (with machining) .....	88	Type of load .....	66
Connectors (without machining).....	90	Universal connector.....	110
Fastening elements .....	141	for profile 30×150.....	110
Profiles .....	8	with knurled cross bushing.....	112
Profiles (plain) .....	8	<b>U</b>	
Profiles (with grooves).....	9	U-Profile.....	57, 78
Tools.....	333	<b>V</b>	
Suspended glider .....	303	Vibration proof .....	85
Swivel angles.....	209	<b>W</b>	
Swivel castors.....	199	Washers.....	328
lockable .....	199	self locking washers .....	328
lockable with bolt hole .....	199	Wedge profiles.....	166
lockable with fitting plate.....	199	Wire net mounting profiles .....	56
with bolt hole.....	199	Wire net profiles .....	50
with fitting plate.....	199	30, F-slot, P .....	50
Symbols .....	5	40, F / E3-slot, P .....	50
<b>T</b>		Wire net, Alu.....	326
Table of contents .....	3	Wire net, steel .....	327
T-Bolts .....	152		
for subsequent insertion.....	152		
Technical data .....	65		
Delivery length .....	65		
Functional length.....	65		
Tension load .....	132		
Thread .....	60		
Threaded bolt for locking castor with center thread.....	201		
Threaded inserts.....	153, 154		
Press-fit threaded inserts .....	155		
Press-fit threaded inserts w/o collar...	155		
Threaded plates.....	142		
for subsequent insertion.....	143		
heavy.....	144		
T-Nut sliding blocks.....	297		
T-Nuts .....	145		
for subsequent insertion.....	146		
with spring.....	147		
with spring ball, E.....	146		
with spring E, 2×M4.....	148		
with spring E, 2×M8.....	147		
with spring F, 2×M4 .....	148		
with spring .....	145		
Tools .....	139, 331		
Drills.....	335, 337		
for anchors.....	333		
for cross bushings .....	333		
for profiles with F- and E-slots.....	337		
for profiles with H-slots .....	335		
Hexagonal tools.....	331		
Milling cutter .....	335, 337		
Press in device for knurled cross bushings.....	331		
Screw taps.....	339		
Special cases for profiles with F- and E-slots .....	338		
Summary .....	333		
Torx® Tools.....	332		

**Imprint**

Subject to technical modification.

All rights reserved.

Copying - also in parts - only allowed by written consent.

© MayTec Aluminium Systemtechnik GmbH,  
Germany, D - 85221 Dachau, 2017



MayTec GmbH plant in Dachau



Small parts storage



Stock of aluminium profiles

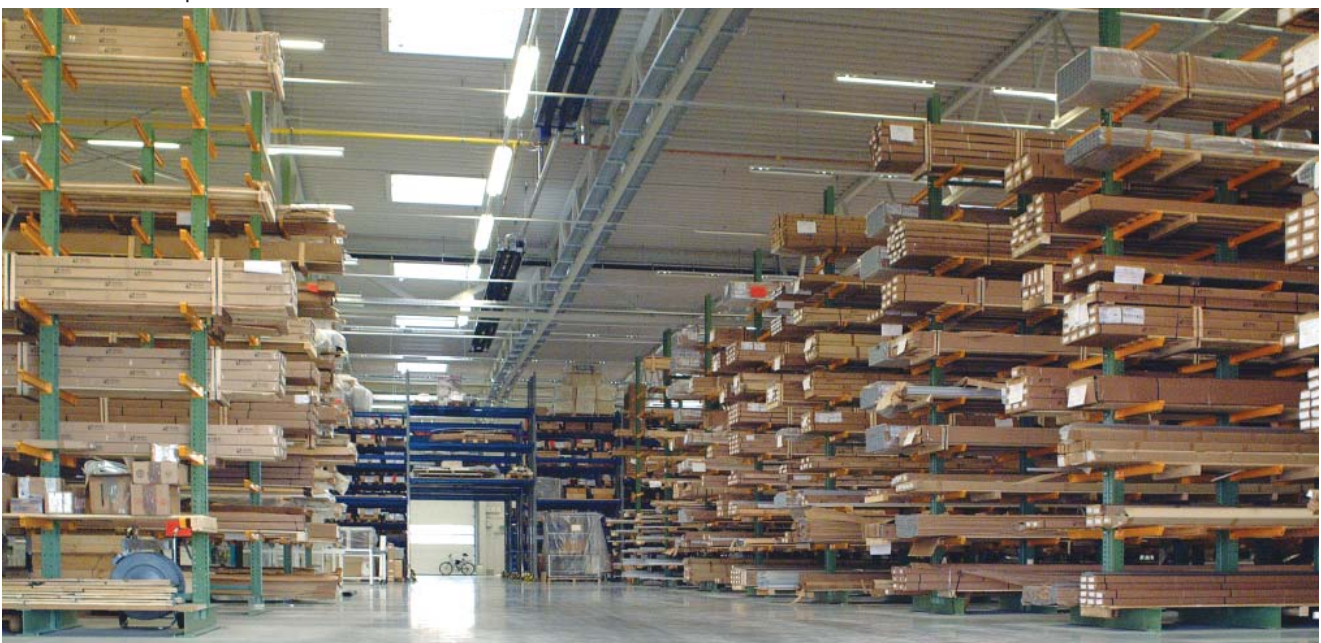

The key ...

to success

extremely strong

efficient

functional

### Australia

**MayTec Australia P/L**

Unit 8, 175 James Ruse Drive  
Rosehill, NSW 2142

country code: +61  
phone (0)2/9898 9929  
fax (0)2/9638 4086  
e-mail: [info@maytec.com.au](mailto:info@maytec.com.au)  
<http://www.maytec.com.au>

### Germany

**MayTec Aluminium**  
Systemtechnik GmbH  
Kopernikusstraße 20  
D-85221 Dachau

country code: +49  
phone (0)8131/3336-0  
fax (0)8131/3336-119  
e-mail: [mail@maytec.de](mailto:mail@maytec.de)  
<http://www.maytec.de>

### USA

**MayTec Inc.**

901 Wesemann Drive  
West Dundee, IL 60118

country code: +1  
phone 847-429-0321  
fax 847-429-0460  
e-mail: [mail@maytecinc.com](mailto:mail@maytecinc.com)  
<http://www.maytecinc.com>

**MayTec distributor**